

UC-5

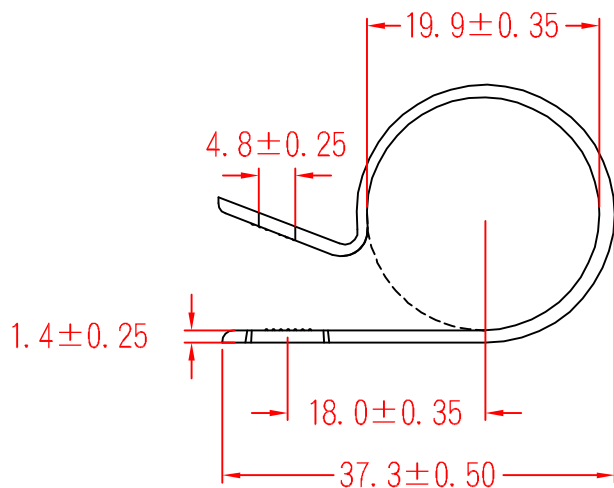

承認
KSS
98.06.02
邱平裕

審查

製圖
KSS
98.06.02
謝文通

設計

中文名
配線固定鈕

MATERIAL: UL 94V-2
NYLON 66

ITEM NO.
UC-5

SCALE

FINISH

NAME
CABLE CLAMP



(. .)

TOLERANCE
AS FIGURE



06-02-2009
DATE

REVISIONS
K001

R.NO.

使用機種



凱士士企業股份有限公司

▶ 請勿實測圖面 ◀