



PoScope4

USER MANUAL



CONTENTS

QUICK START GUIDE	4
INTRODUCTION	5
PoScope4 measurement package	7
poscopemega1(+) and poscopemega50 HARDWARE CONNECTIONS	10
Top view	10
Front view.....	10
Back view	10
PINOUT ASSIGNMENT	11
INPUTS AND OUTPUTS	11
SOFTWARE INSTALLATION	12
SOFTWARE MANUAL	18
PoScope4 user interface.....	19
Organize your desktop	20
Change language settings and displays layout.....	20
Device displays	24
Device controls GUI.....	27
PoScopeMega1+ controls GUI.....	27
PoScopeMega50 controls GUI.....	28
OSCILLOSCOPE.....	30
Capture mode.....	32
Analyze mode	35
Exporting data	40
PoScopeMega1+ sampling frequency (analog and digital DAQ mode)	41
Using multiple devices in PoScope4.....	42
X/Y SCOPE.....	43
SPECTRUM ANALYZER	48
RECORDER	52
LOGIC ANALYZER	55
I2C DECODER.....	60
UART DECODER	65
SPI DECODER	66
FUNCTION GENERATOR (Only for Mega1+ and Mega50 devices)	67
TECHNICAL SPECIFICATIONS FOR MEGA1(+)......	72

TECHNICAL SPECIFICATIONS FOR MEGA50..... 73
LEGAL NOTES..... 74
GRANT OF LICENSE..... 76

QUICK START GUIDE

STEP 1 DOWNLOAD AND INSTALL SOFTWARE

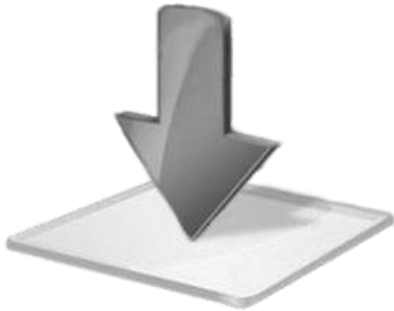

STEP 2 PLUG IN YOUR DEVICE INTO USB



STEP 3 ATTACH PROBE TO YOUR DEVICE



STEP 4 START USING YOUR DEVICE



System requirements (recommended):

OS: Windows10/Windows8/Windows 7/Vista/XP (32 or 64 bit)

CPU: Intel Core2 or equivalent processor

RAM: 4GB

Display card: Windows display adapter capable of 1024x768 with True Color capabilities.

Free disk space: 1GB

At least one USB 2.0

INTRODUCTION

Dear customer!

Thank you for choosing our products. We prepared this handy manual for you to get to know your new device and software a little better. If you bought measurement device (PoScopeMega1+ or PoScopeMega50) bundle package also contains:

- PoProbe 60 (60 MHz probe),
- PoProbe L2 (Logic Analyzer DB-25 probe),
- standard USB cable.



PoScope Mega1+ or PoScope Mega50

Bundle package

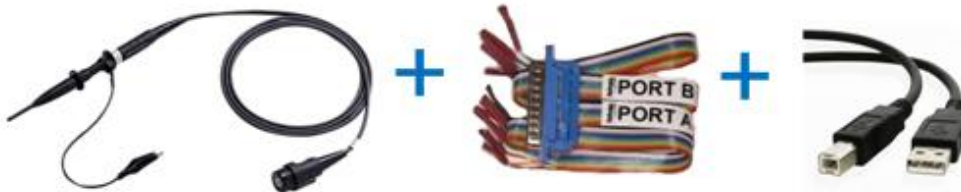

Please note that all devices are powered through USB connection.

We provide free software (including drivers) and updates for all our PoScope devices and you can always download it from our web site www.poscope.com. Just install it to your PC, then connect plug & play device and you are ready to go!

Besides measuring electric signals, your new device can perform some other tasks. For instance, you can record your measurements, use the device for spectral analysis, decipher most known digital communication protocols, and even analyze digital circuits with easy-to-use 16-channel logic analyzer. PoScopeMega1+ and PoScopeMega50 includes function generator that can output common used waveforms which are needed in various tasks of electronic design & debug.

Our youtube channel provides an access to many tutorials on how to use your device and software. Visit us on youtube: www.youtube.com/poscopelabs

If you still encounter any difficulties with the device or you have further questions, please don't hesitate to use our support system on the link: <http://support.poscope.com>

Best regards,

PoScope TEAM

POSCOPE4 MEASUREMENT PACKAGE

PoScope measurement package consists of:

- **PoScope hardware** (PoScopeMega1, PoScopeMega1+, PoScopeMega50, PoRef216UI, PoRef216U-50V etc.),



- **PoScope4 software**



Every device / hardware supported in PoScope4 has dedicated control GUI within PoScope4 environment which is used for control and configuration purposes. Currently supported measurement devices are PoScopeMega1, PoScopeMega1+, PoScopeMega50. Beside measurement devices we offer also generators of voltage/current PoRef216UI and PoRef216U-50V.

- **PoScopeMega1 / PoScopeMega1+ control GUI**

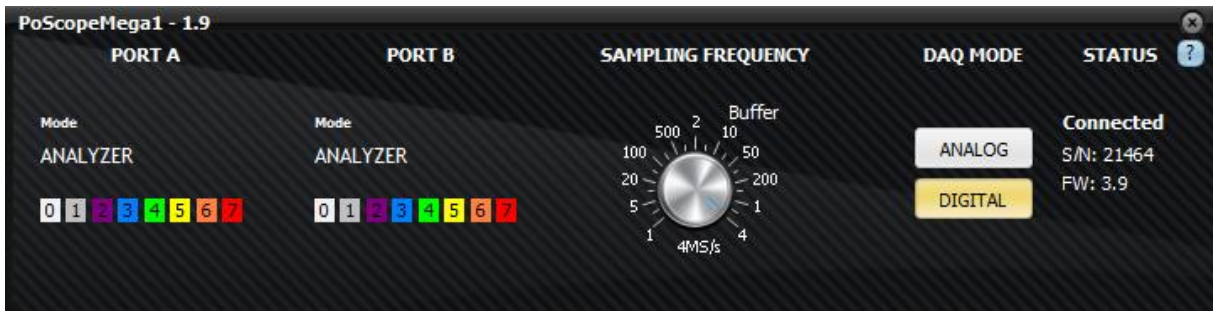
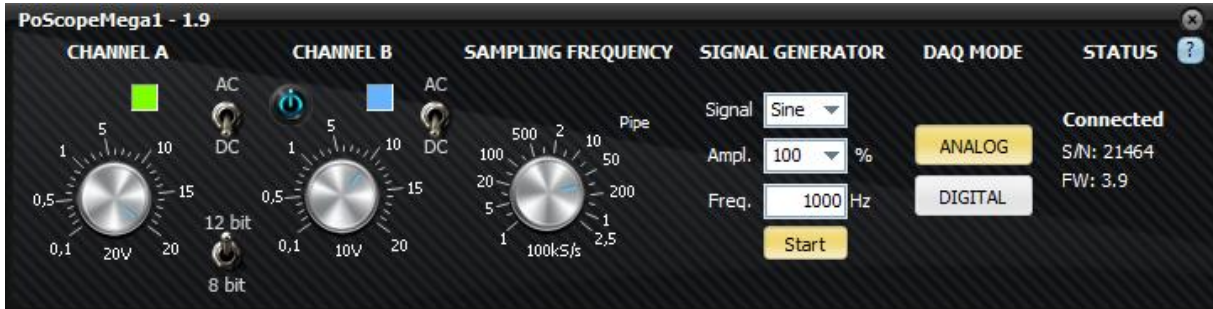

- **PoScopeMega50 control GUI**

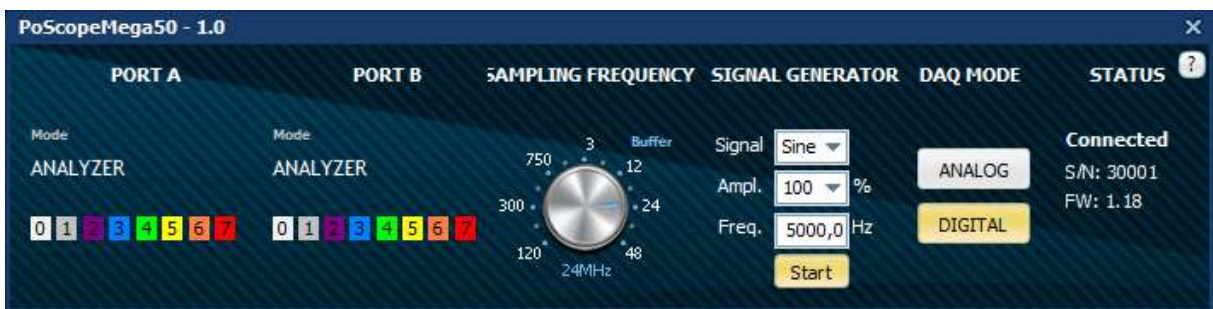

- PoRef216UI control GUI

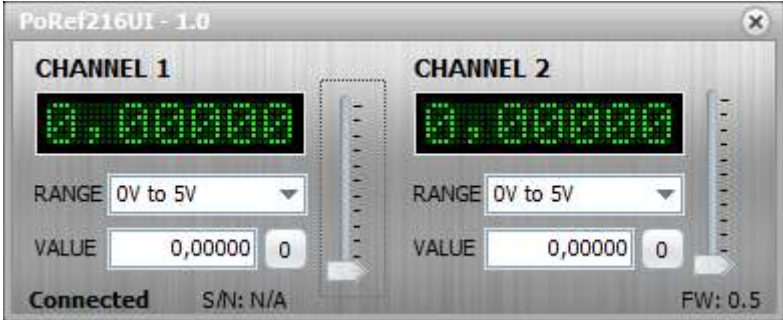

- PoRef216U-50V control GUI

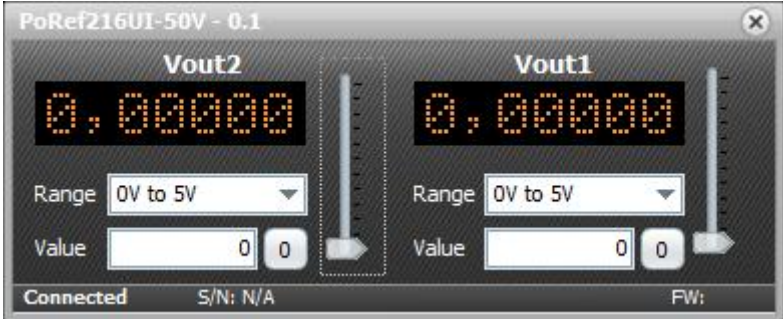

POSCOPEMEGA1(+) AND POSCOPEMEGA50 HARDWARE CONNECTIONS

PoScopeMega1 (without signal generator BNC), PoScopeMega1+, PoScopeMega50

Top view

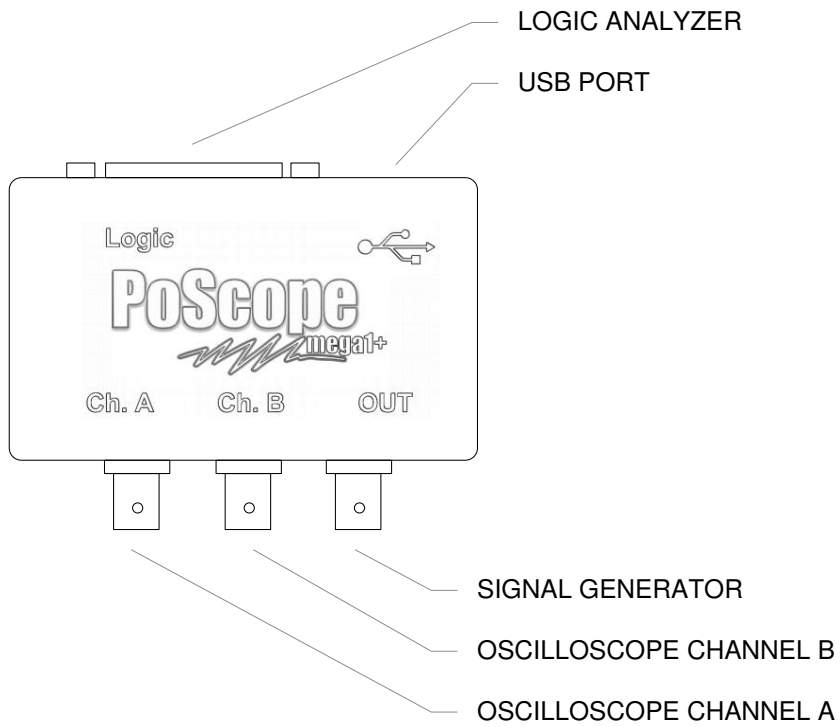

Front view

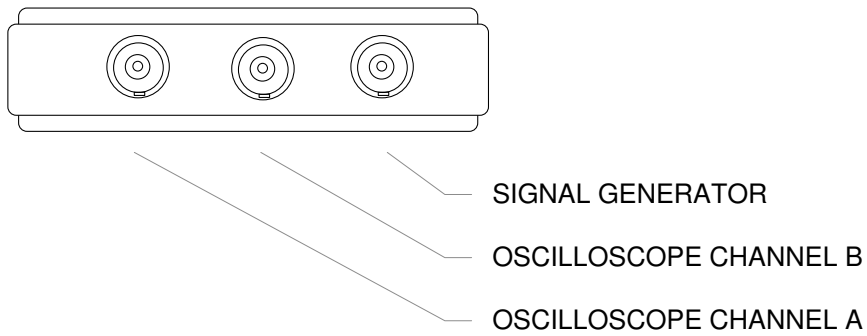

Back view

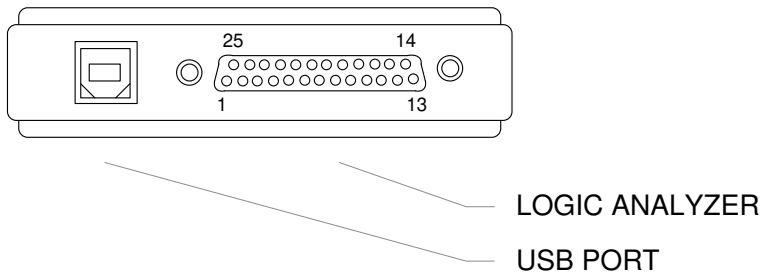

PINOUT ASSIGNMENT

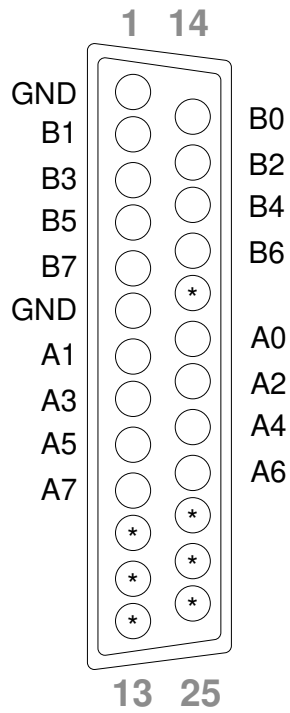

* DO NOT USE! FACTORY PURPOSE ONLY.

INPUTS AND OUTPUTS

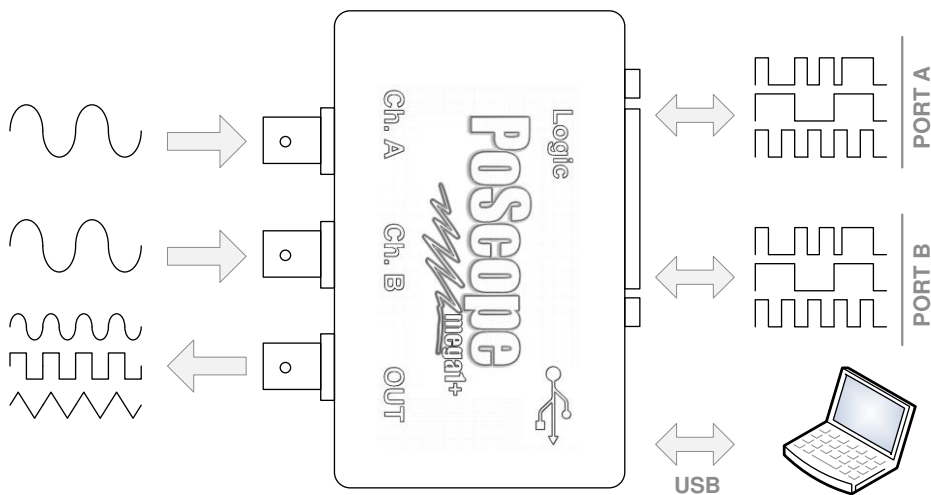

SOFTWARE INSTALLATION

1

Go to www.poscope.com, under measuring instruments → **PoScope Mega1** → **Downloads**, you will find 32-bit and 64-bit latest version of PoScope software. Download & install under **Administrator** rights.

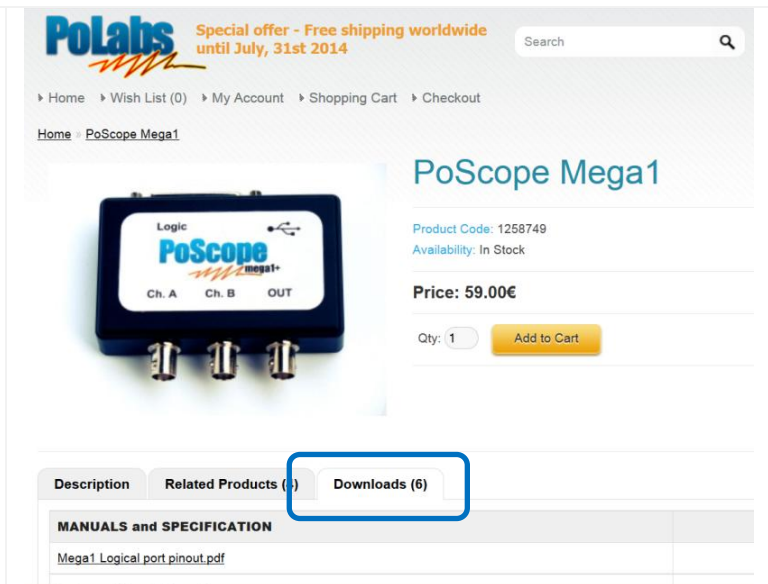

The screenshot displays the product page for the PoScope Mega1 on the Polabs website. The page includes a search bar, navigation links (Home, Wish List (0), My Account, Shopping Cart, Checkout), and a special offer banner for free shipping worldwide until July 31st 2014. The product image shows a blue PoScope Mega1 device with three ports labeled Ch. A, Ch. B, and OUT. The product details include the product code 1258749, availability 'In Stock', and a price of 59.00€. A quantity selector is set to 1, and an 'Add to Cart' button is visible. Below the product image, there are tabs for 'Description', 'Related Products (0)', and 'Downloads (6)'. The 'Downloads (6)' tab is highlighted with a blue box. Underneath, there is a section titled 'MANUALS and SPECIFICATION' with a link to 'Mega1_Logical_port_pinout.pdf'.

2

Follow on-screen instructions & go through PoScope installation procedure. It is advised to close all other programs at this point of the installation.

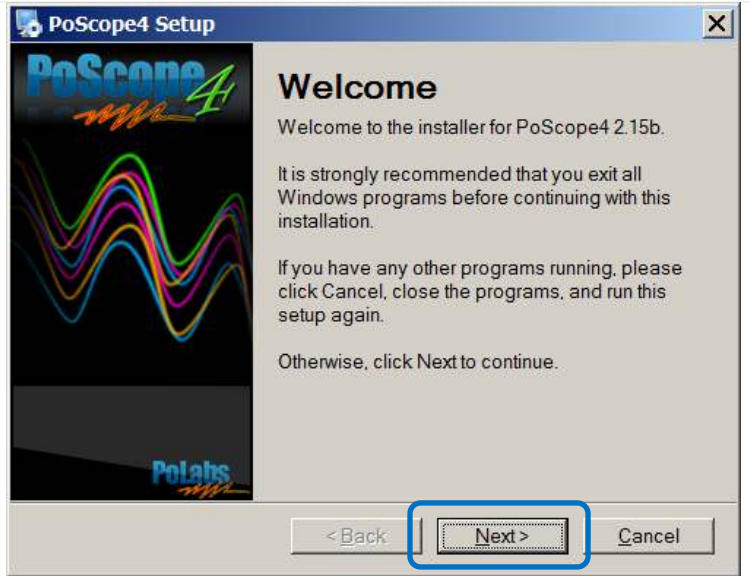

3

It is advised to remove the old version before proceeding, if you have one installed. Leave the tick in the checkbox.

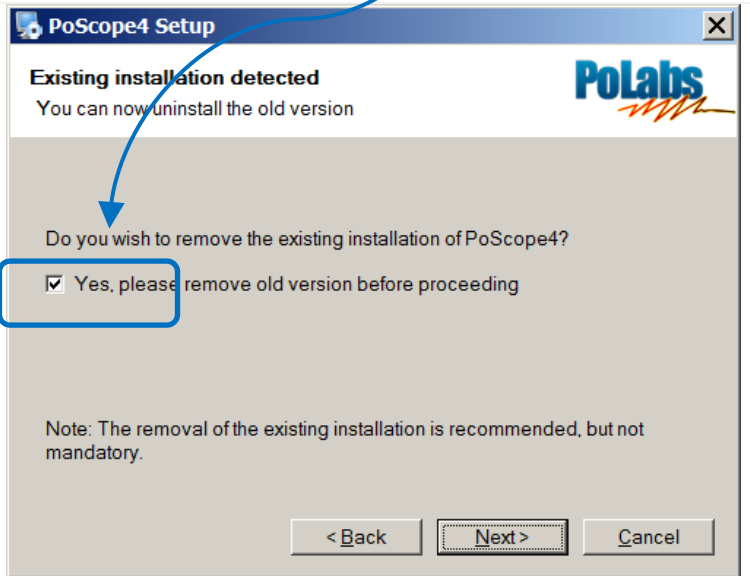

4

Package selection window lets you choose which program features to install. If you don't plan to use other devices in near future, you can deselect them by clicking the checkbox next to it. You can always install it later, if needed.

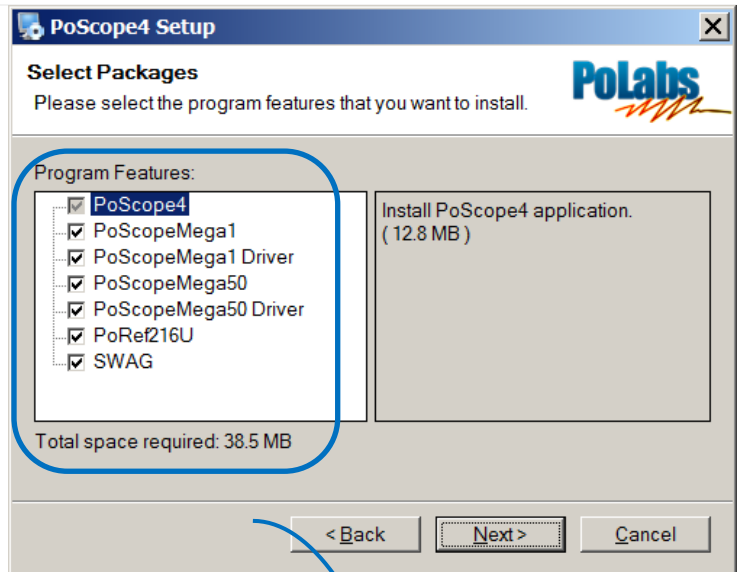

5

You can change the location, where the PoScope files get installed. If it's ok as suggested, just click Next.

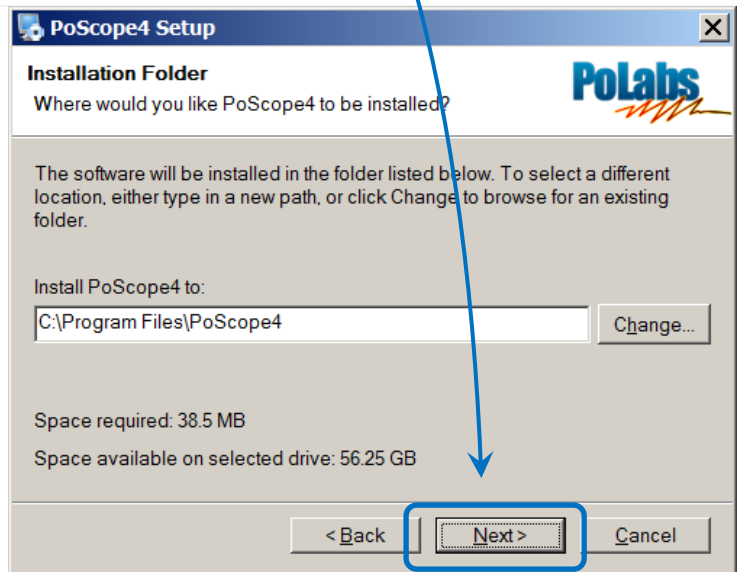

6

You can make the shortcut for PoScope available to all users or just to the currently logged Administrator.

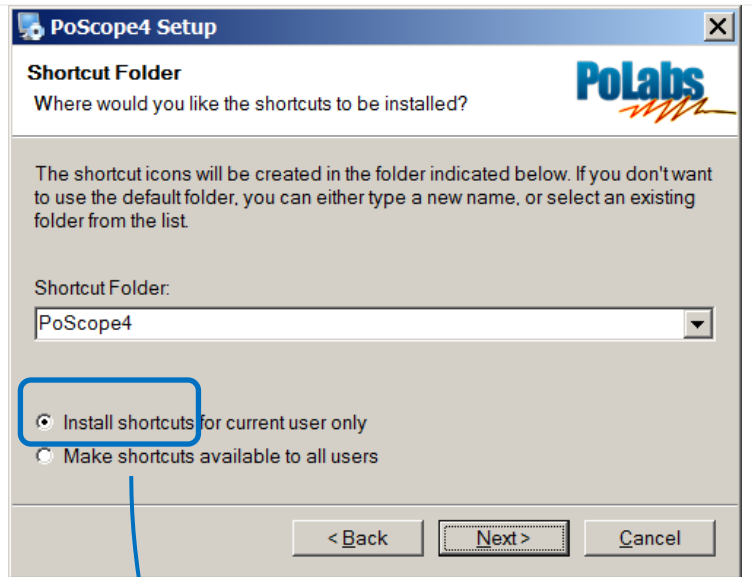

7

Installation window summarizes the installation settings; installation folder & shortcut name. If everything is OK, you're ready to go. Click next.

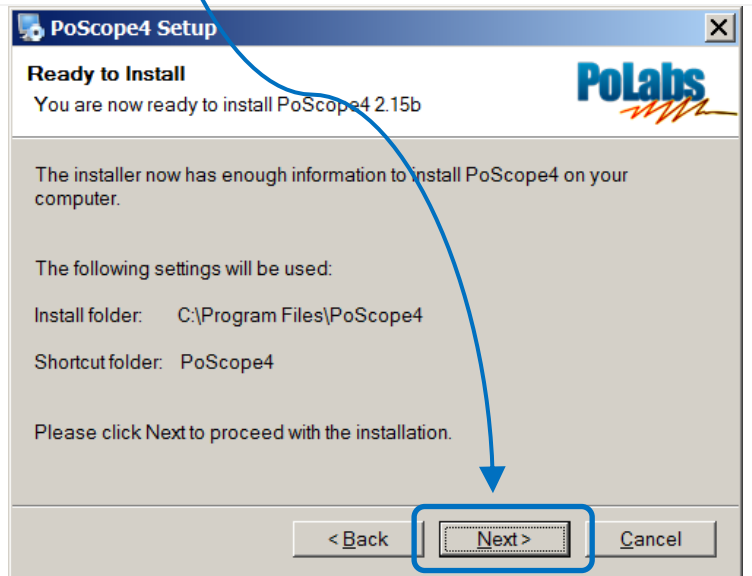

8

Please wait until the setup installs all the files to your PC.

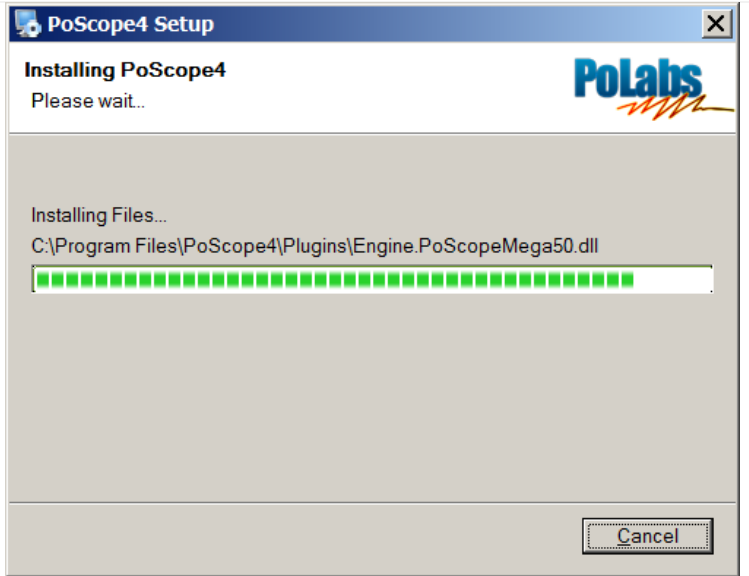

9

Setup window informs you about the device driver installation. No settings needed, just click next.



10

Green tick means that device drivers are installed and the device is ready for use. Click finish.

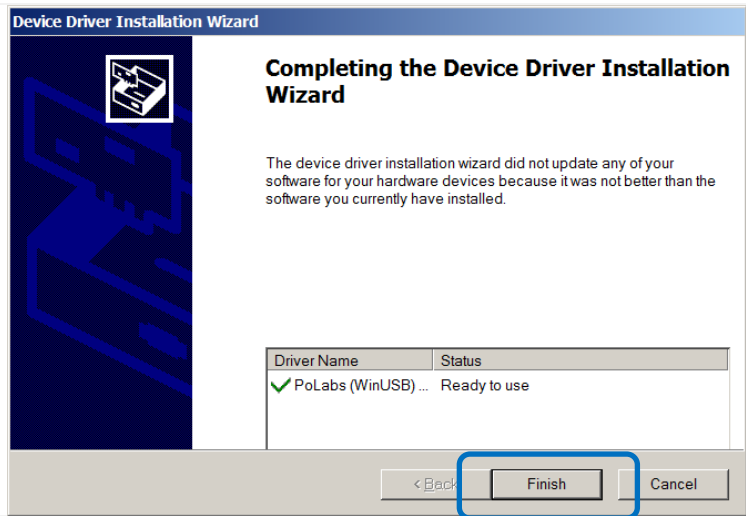

11

You are being informed about the successful installation of PoScope software with drivers. We are ready to move on & learn how to use the installed software. Click finish.

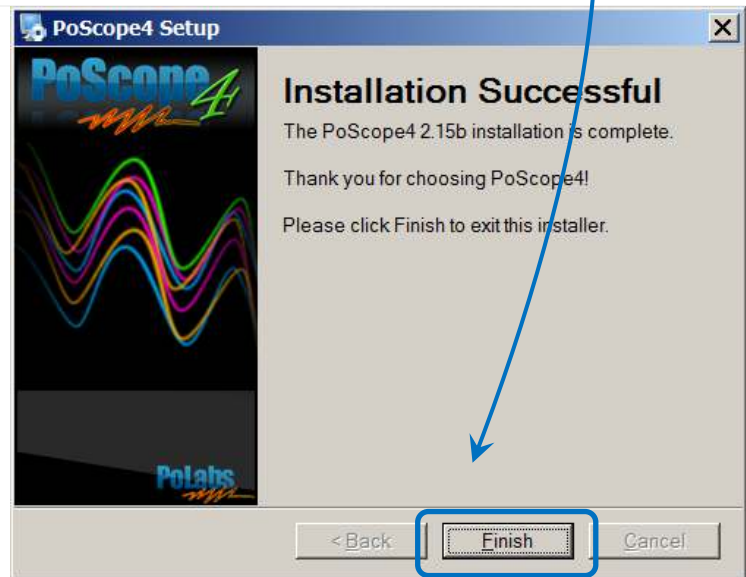

SOFTWARE MANUAL

Run PoScope software:

You will find PoScope shortcut under PoScope folder of your startup menu.

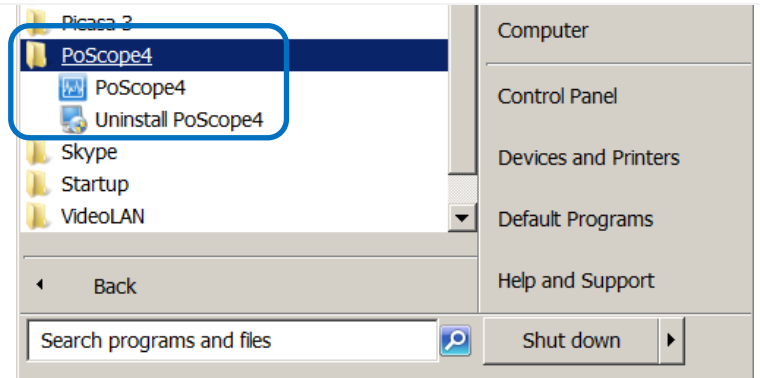

PoScope4 user interface

PoScope4 user interface consists of the following items:

- Main menu
- Device displays
- Analyze / Capture button
- Devices
- Event log and Status toolbar

Main menu is organized into tabs. Device displays open new windows which represent various oscilloscope functions.

Analyze / Capture button is used to switch between the Analyze and Capture mode. In Capture mode the signal waveform is being captured for analysis purposes. In Analyze mode you can perform in-depth signal analysis.

Devices are represented as icons of available devices. When we click them, device controls open. When we click them again, the device controls will close.

Event log is used for system diagnostics. In case of device misbehavior, open the event viewer, copy the events & paste them to a notepad file and send it to our support staff for further diagnostics.

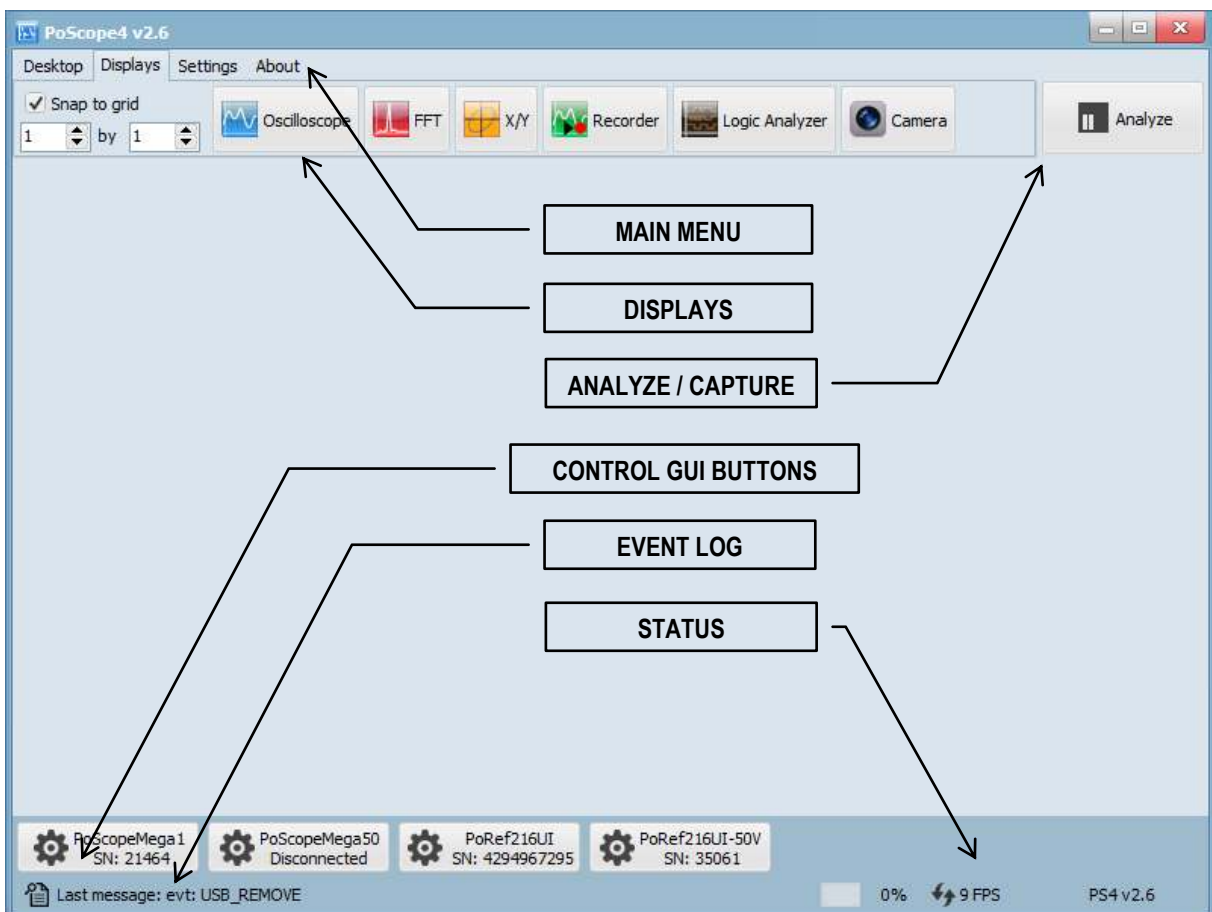

PoScope4 version 2.6 user interface

Organize your desktop

The **Desktop tab** lets you manage your work area – the desktop. You can freely organize the displays that are open in work area and save their configuration as a desktop file, so you don't have to organize them every time you restart the PoScope 4 application. Next time you open PoScope 4, last known configuration will automatically open. In desktop tab you can create new desktop configuration, open previously saved configurations and save currently set configuration.

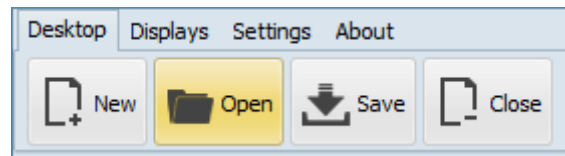

Displays tab contains the following icons:

- Snap to grid
- Oscilloscope
- Frequency analyzer (FFT)
- X/Y Scope
- Recorder
- Logic analyzer

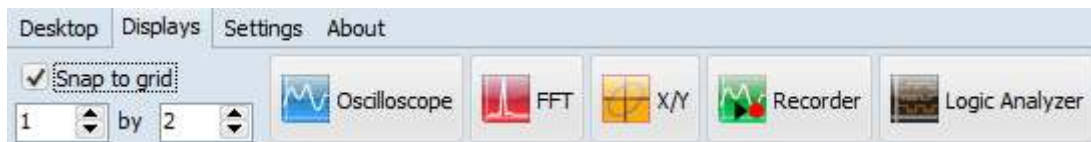

Change language settings and displays layout

When you press the Settings button, the tab dialog window will open:

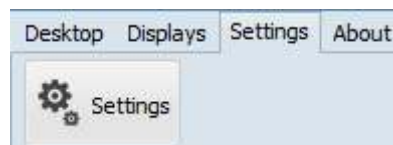

- General tab will allow you to:
 - **Invert mouse scroller function**
(zoom on forward / backward scroll)
 - **Choose between Classic or Dynamic layout**
(Classic layout keeps the Device displays in the frame of main application, while the Dynamic layout lets you freely move Device displays even over multiple monitors)
 - **Change user interface language**
The Language settings allow you to choose the language of the user interface. In order to change the language setting, application reset is required.
 - **GUI**
Setting target frame rate affects refresh rate of data on display. Higher the value faster the refresh rate (if possible).
 - **Check version**
Skips checking for new version on our web page at PoScope4 startup

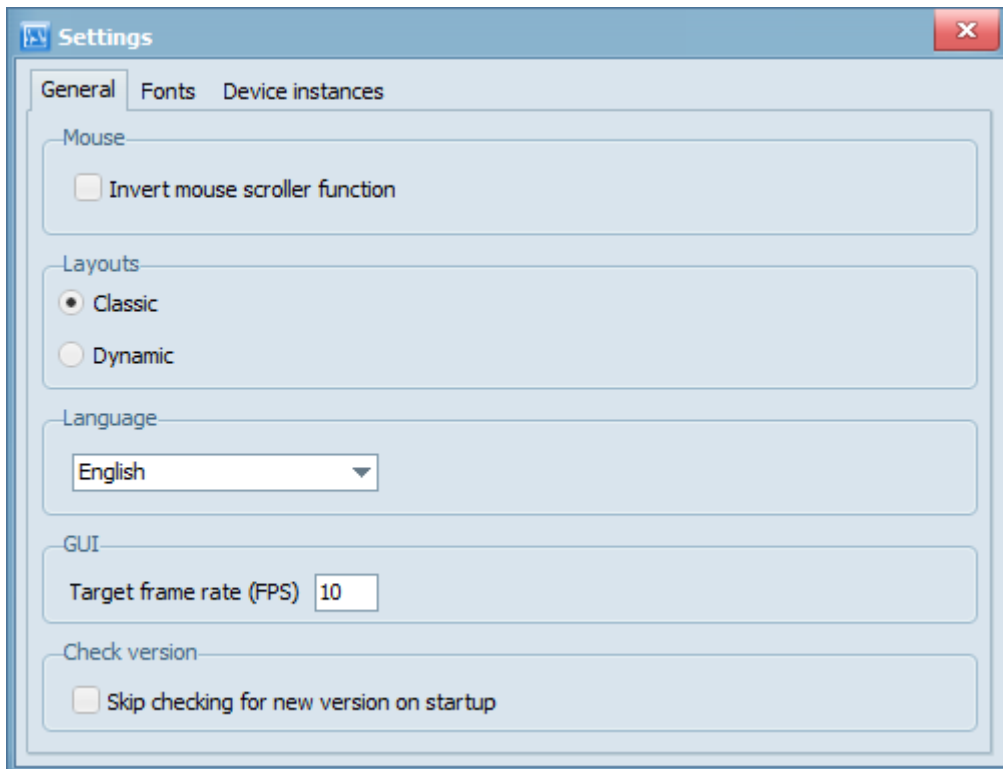

General tab settings

Fonts are also fully configurable. Find the fonts settings under the Settings tab. The **Fonts dialog box** lets you configure the size of the fonts for each application segment.

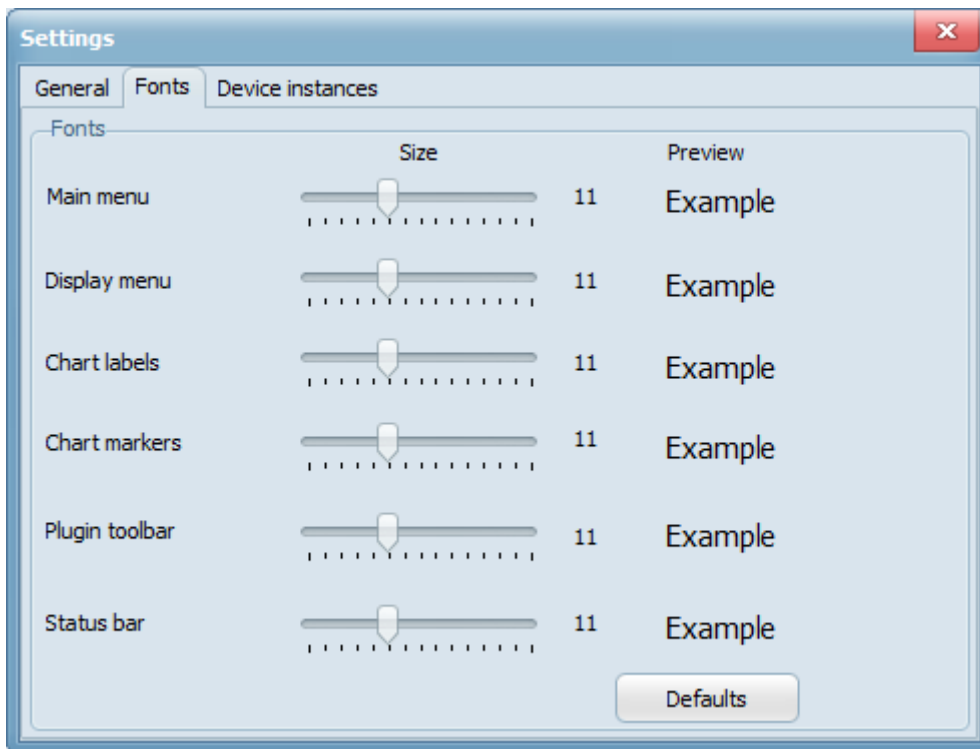

Font size user interface

You can set the number of connected devices in the device instances tab.

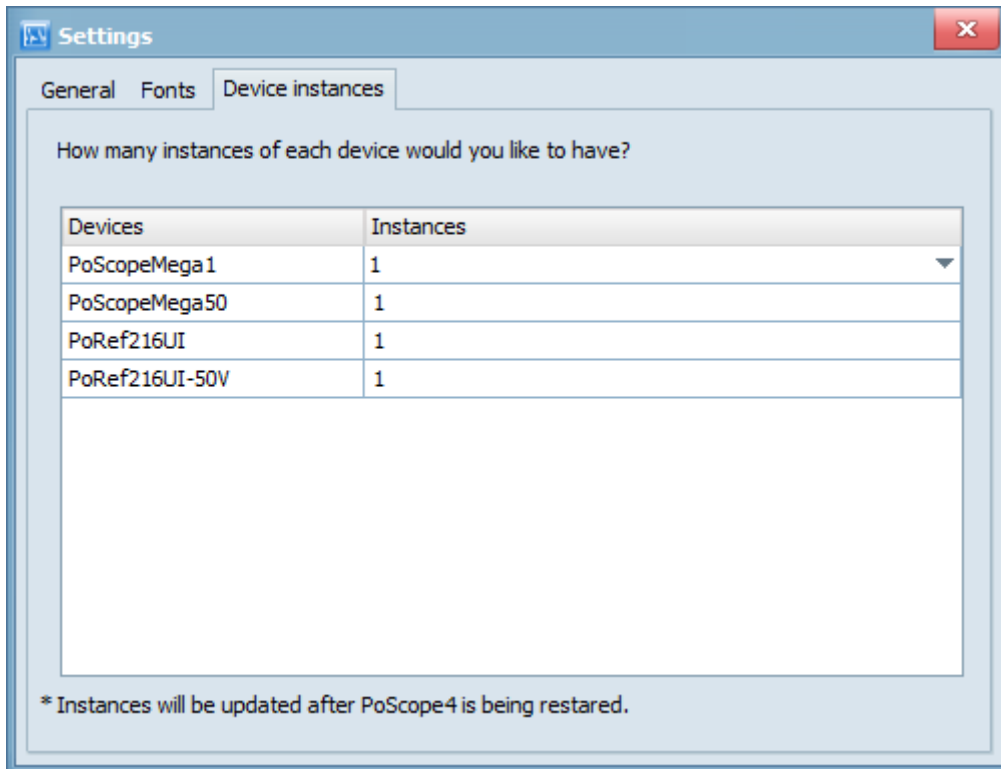

Device instances setup

On our website you can find latest release of the PoScope4 software and new devices, including the PoScope oscilloscopes and PoKeys controllers. YouTube channel provides installation and video tutorials on how to use the PoScope devices.

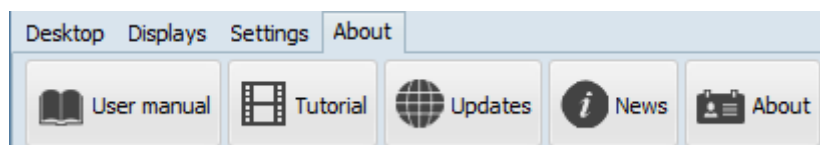

Device displays

The **Snap to grid** lets you automatically tile the displays in the working area in different configuration. First number is Row and second is Column. When Snap to grid checked all displays will be positioned in a grid of size Row by Cols.

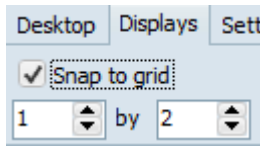

If none of the above is appropriate for your use, you can always tile the displays by yourself as you wish. The location and size of the displays in the working area are fully customizable. Displays tab also shows device functions.

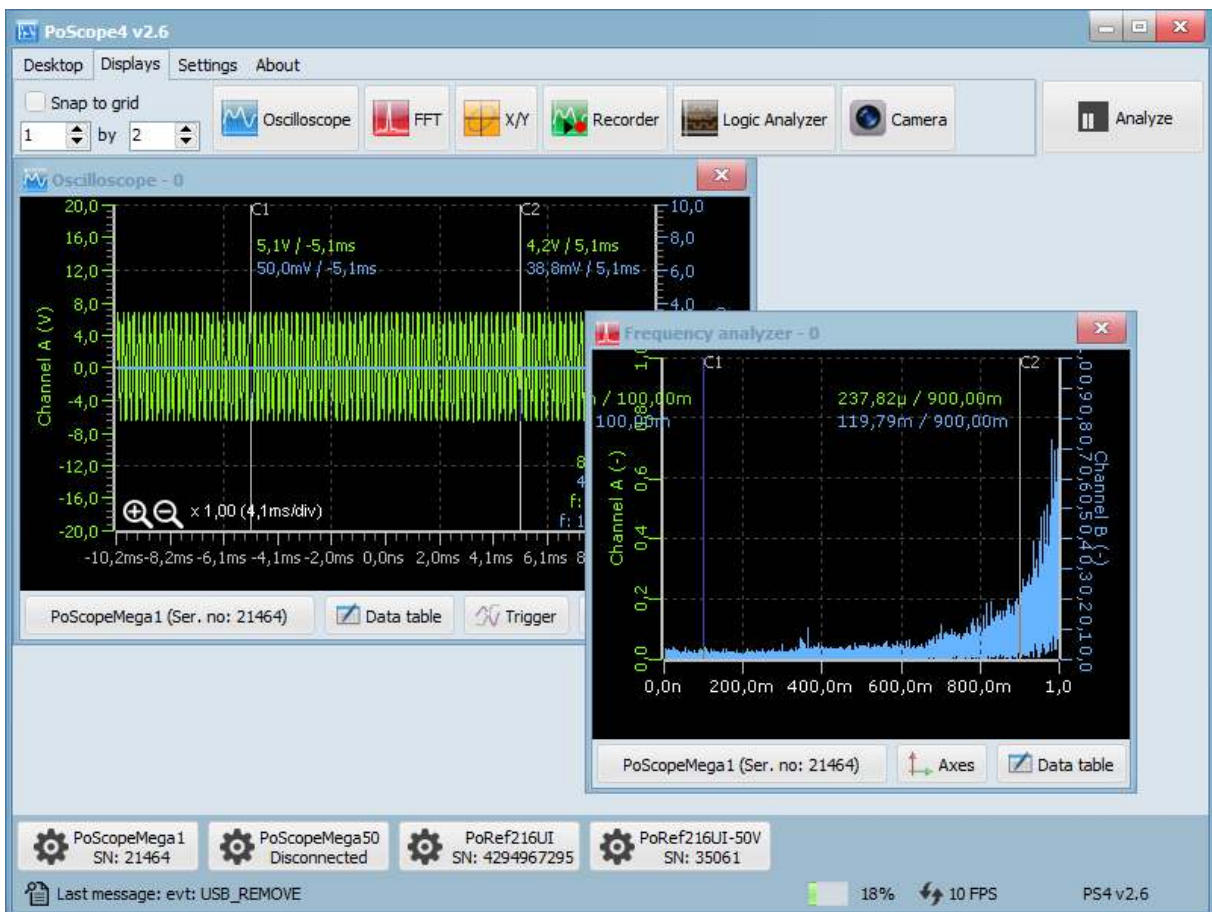

Device displays when snap to grid is not checked

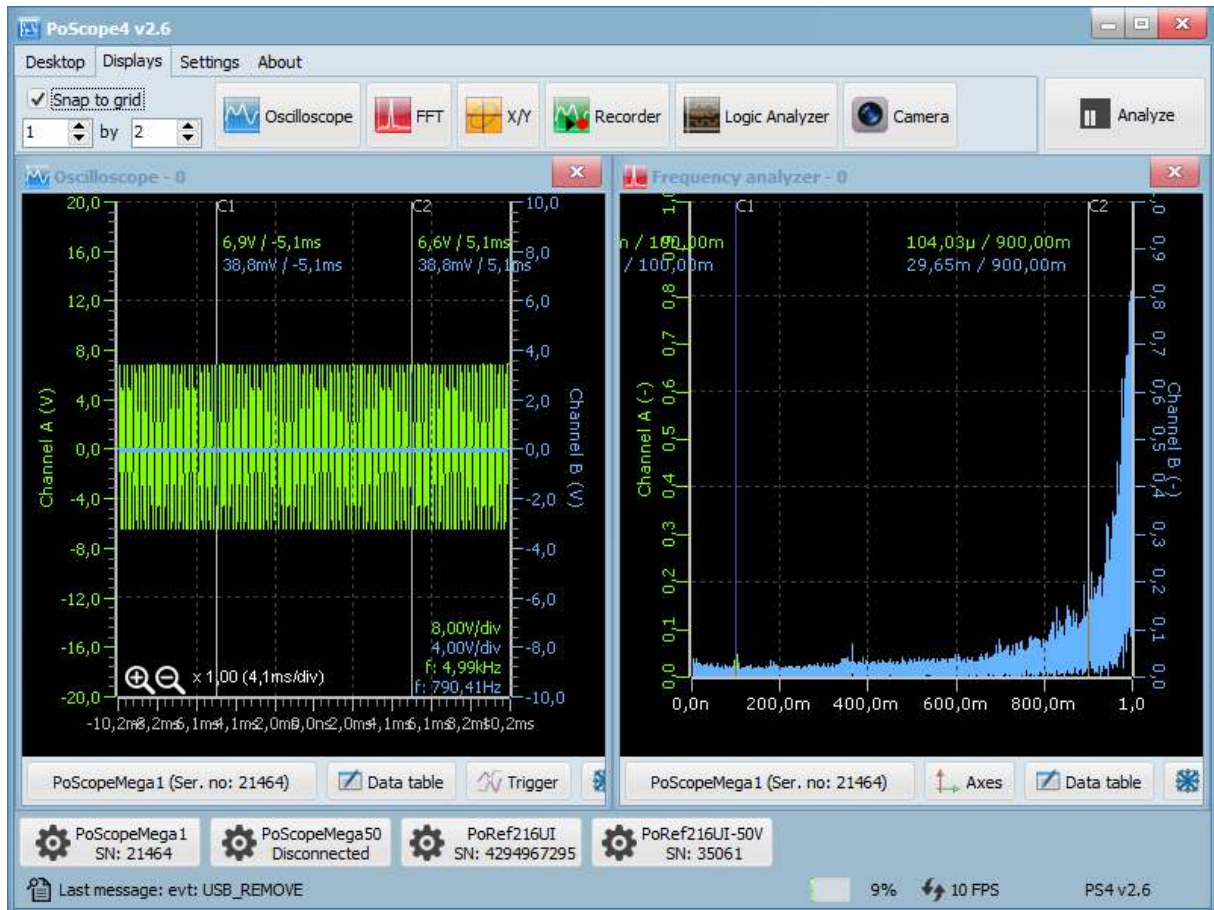

Device displays when snap to grid is checked

Dynamic layout is also available. You can set it in the settings menu. The Device layout lets you place Device displays also outside the main application, therefore it might come handy when multiple monitors are connected to the computer.

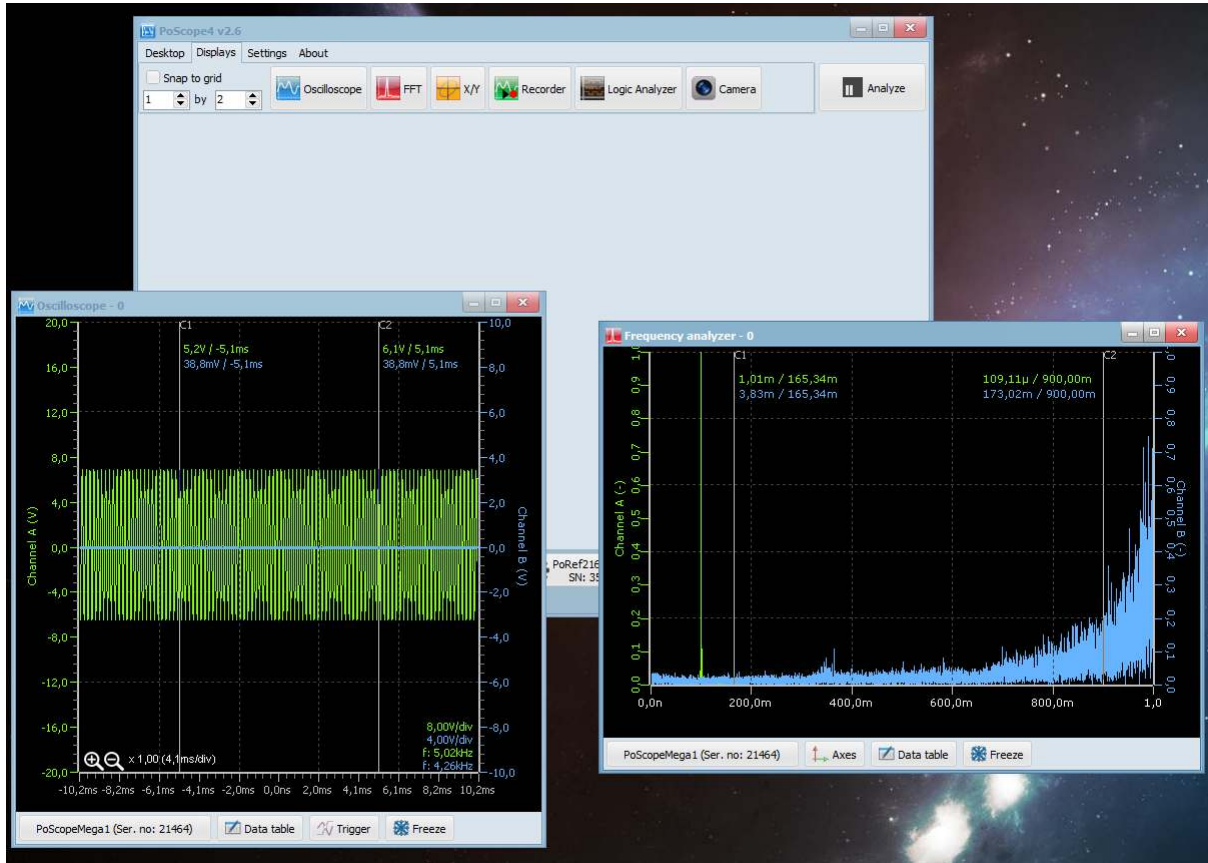

Device displays outside the main application in Dynamic mode

Device controls GUI

All supported real devices has their graphic representation in PoScope4. We call then **Device control GUI** and as name suggest we use them to setup and control connected devices. Buttons to toggle their visibility are located at the bottom of the main PoScope4 window.

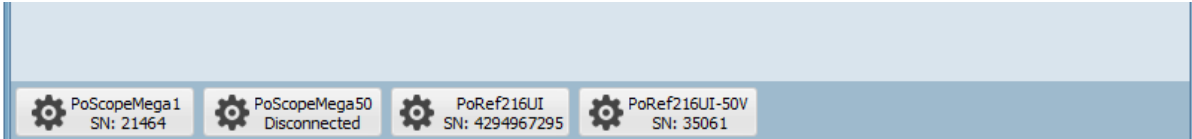

Buttons for devices control GUIs

PoScopeMega1+ controls GUI

PoScopeMega 1+ controls will open, showing you next settings:

- Channel input range setting for each channel (A, B)
- Channel color
- AC / DC pushbuttons (cuts off DC component)
- ON / OFF button for channel B
- Sampling frequency setting
- Signal generator settings (waveform, amplitude, frequency)
- 8-bit and 12-bit switch
- Analog / Digital DAQ mode switch

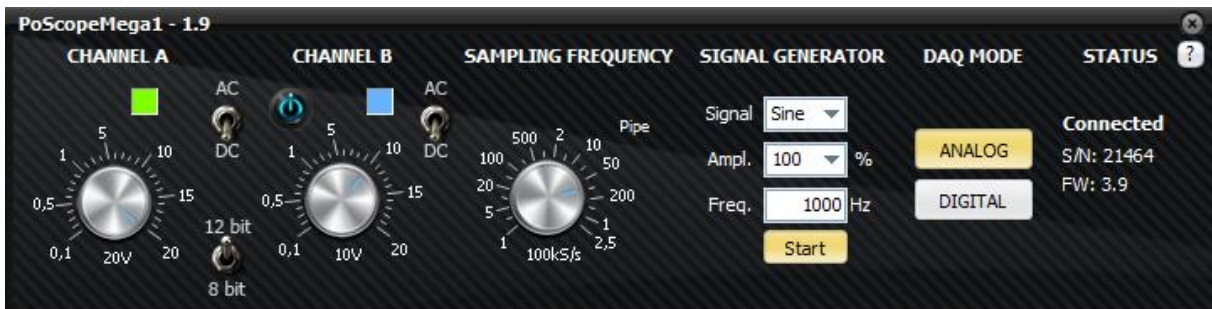

Poscope Mega1+ control gui (analog mode)

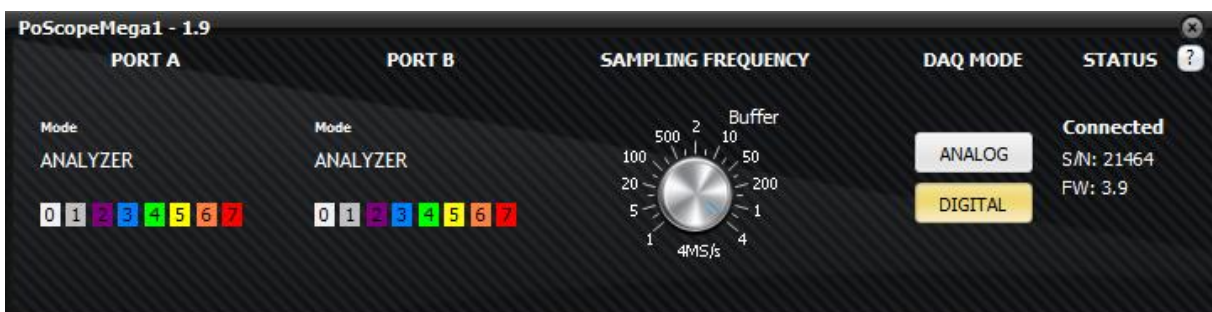

PoScope Mega1+ control gui (digital mode)

The color of graphic signal representation of each channel is also customizable by **clicking** the color panel below the channel name.

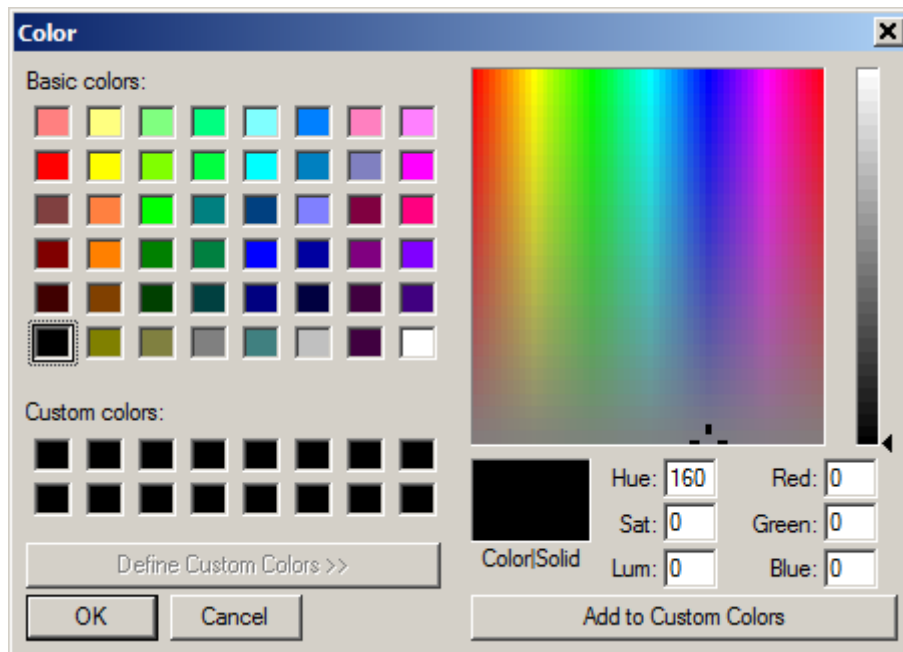

Signal color settings

PoScopeMega50 controls GUI

PoScopeMega 50 controls will open, showing you next settings:

- Channel input range setting for each channel (A, B)
- Channel color
- AC / DC pushbuttons (cuts off DC component)
- ON / OFF button for channel B
- Sampling frequency setting
- Signal generator settings (waveform, amplitude, frequency)
- Analog / Digital DAQ mode switch

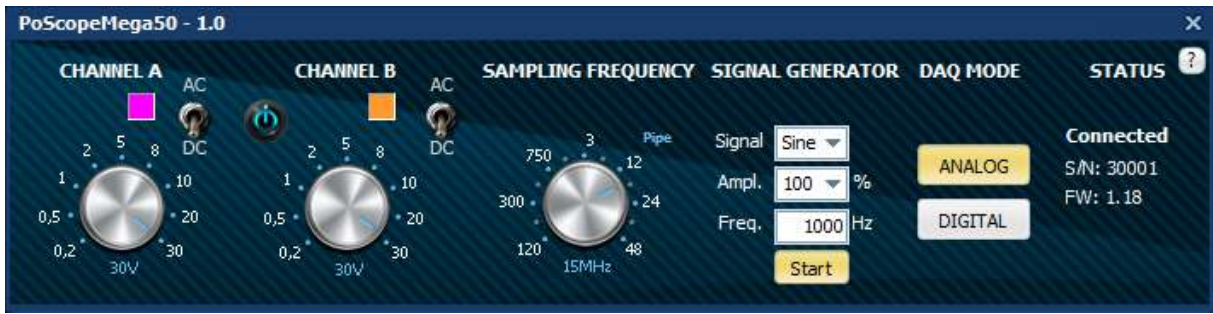

Poscope Mega50 control gui (analog mode)

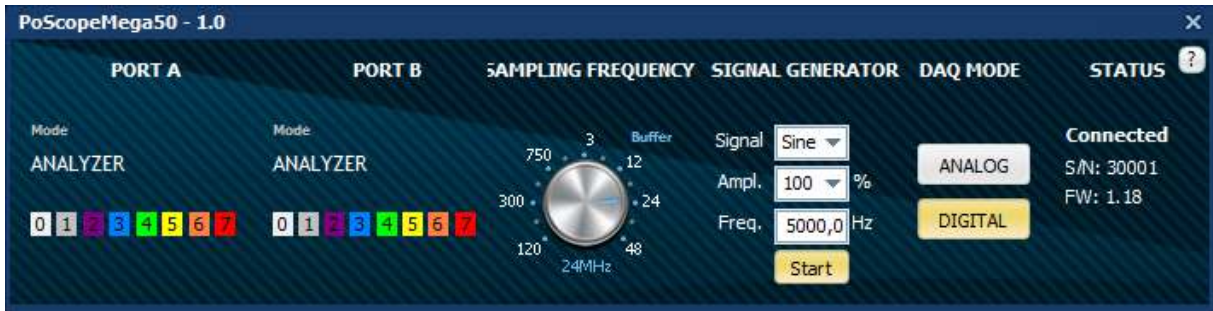

Poscope Mega50 control gui (digital mode)

The color of graphic signal representation of each channel is also customizable by **clicking** the color panel below the channel name.

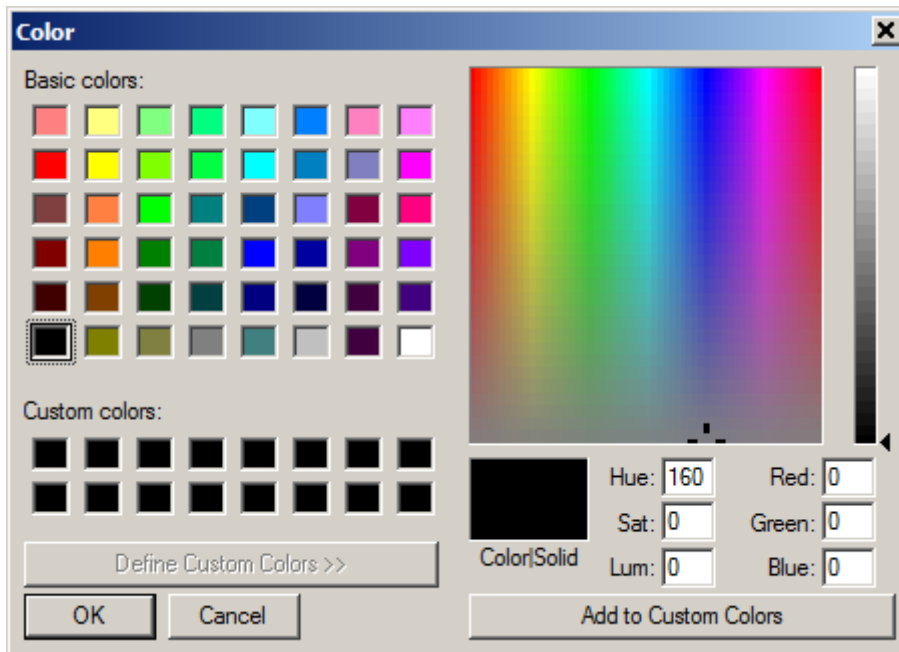

Signal color settings

OSCILLOSCOPE

Oscilloscope is an electronics measurement device that visually represents an electric signal, either alternating or direct current (AC or DC). An oscilloscope graphically shows variations of voltage. As such it is appropriate for measuring and analyzing fast changing electric signals.

For this example we connected the analog generator output to oscilloscope channel A of the same PoScopeMega1 device. You can do that by using 2 probes. Plug them to CH.A and OUT and connect the probe's tips and the probe's grounds.

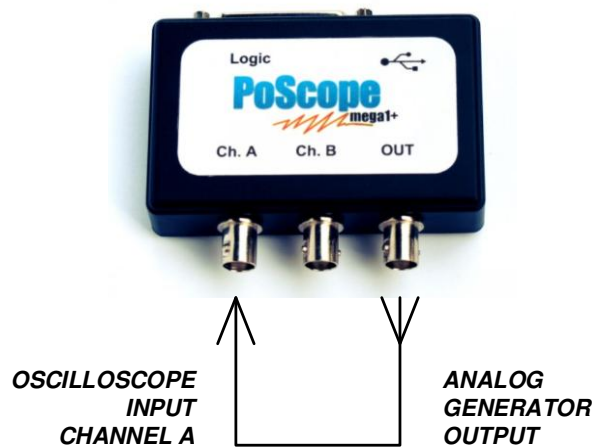

You can open the oscilloscope by clicking **Oscilloscope** icon in the device functions menu.



Displays menu

You might come across the message: Device not in analog mode. In that case you will have to open the PoScopeMega1 controls and **switch** the device back to **analog mode** in the DAQ section.

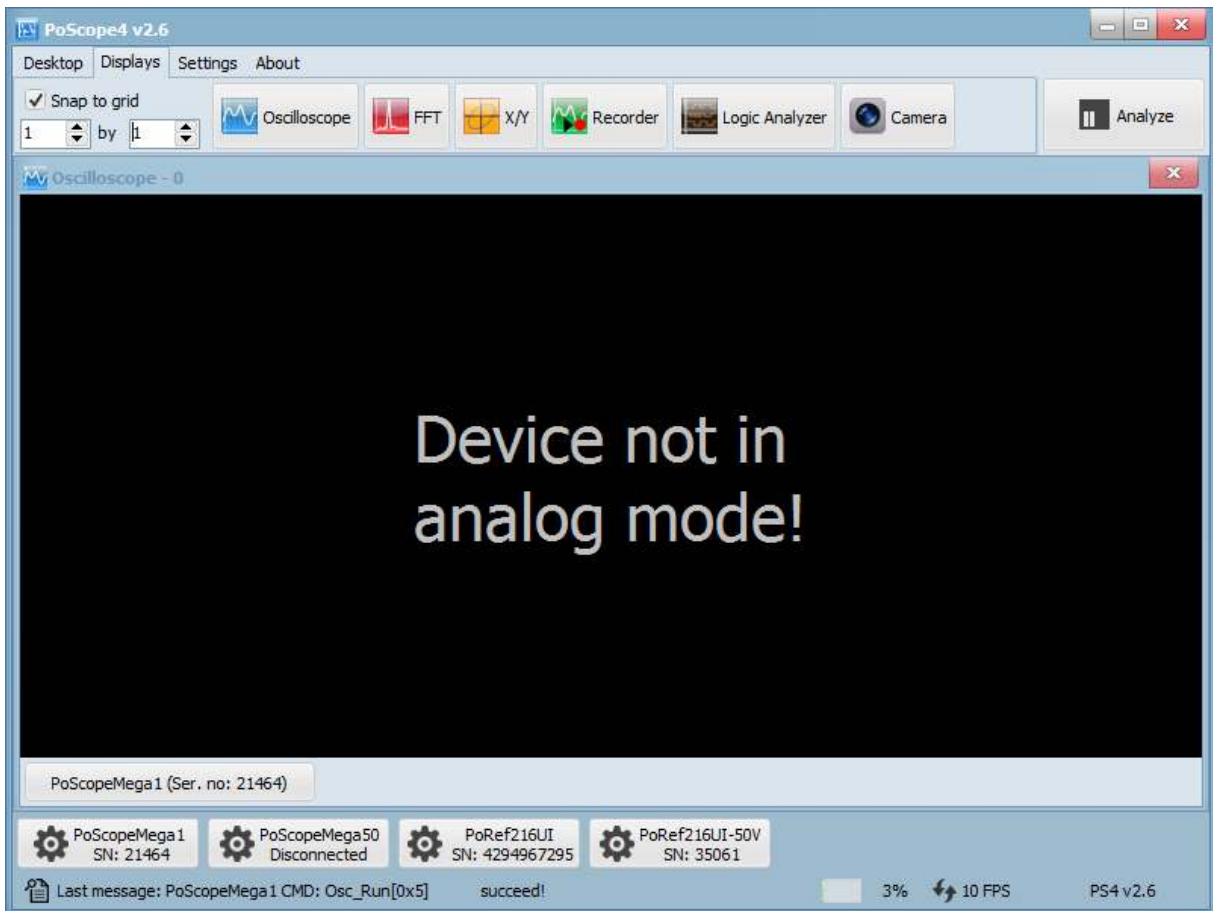

"Device not in analog mode!" Error message

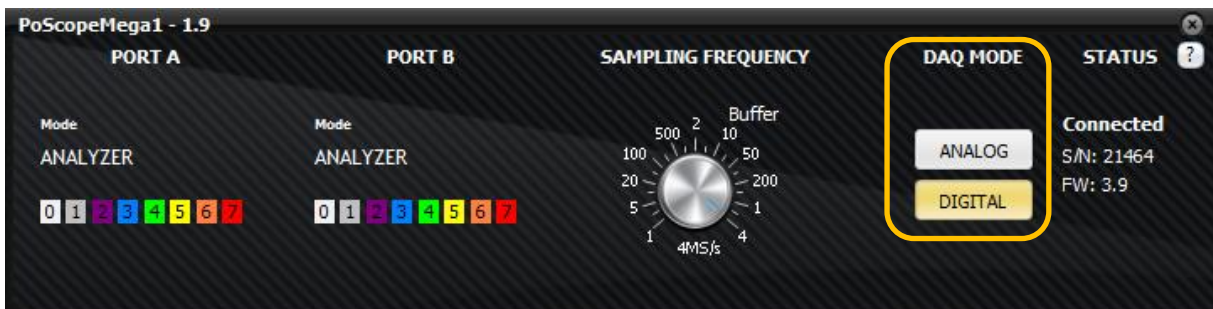

Device controls – digital mode

Capture mode

A window will open, showing graphical representation of a measured signal. To expand the **timebase**, find the magnifying glass icons in the bottom left corner of the oscilloscope display.



Magnifying glass icons for timebase setting

After expanding the timebase you will get far better graphical presentation of the observed signal. To view the controls of the device, you have to click the device buttons area of the GUI. To view the device controls of oscilloscope PoScope Mega1+, left-click the PoScopeMega1 button. If you have multiple devices connected, they will be listed here. Previously you have to set higher number of device instances in the settings menu.

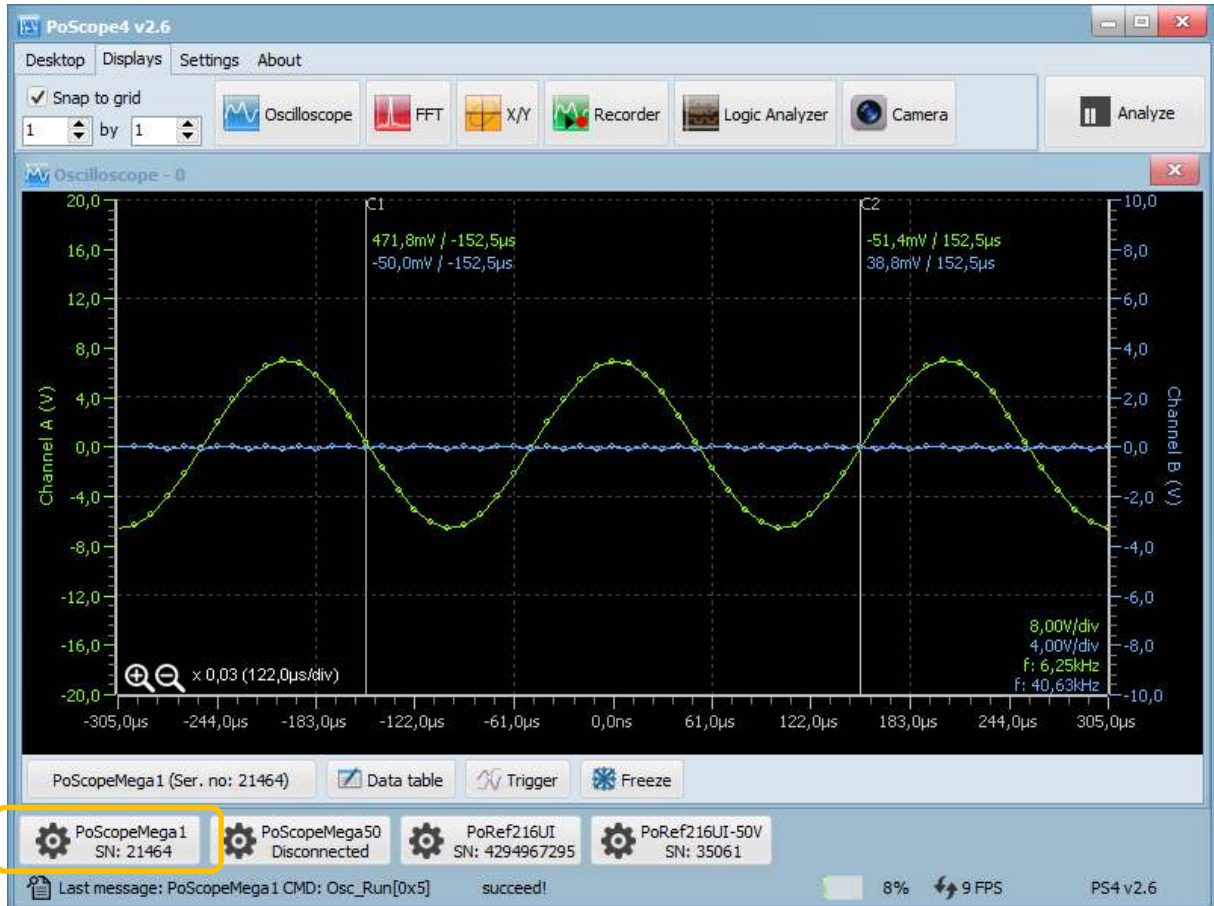

There are two ways how to change voltage range of input. First way to change it by simply left-click & drag channel knob on control GUI or using mouse scroll wheel with mouse positioned above the knob. The second way is to move mouse over the axis on chart and scroll mouse wheel. The result will be same for both methods. Under the settings menu you can invert mouse scroll function if you prefer different behavior when scrolling up or down.

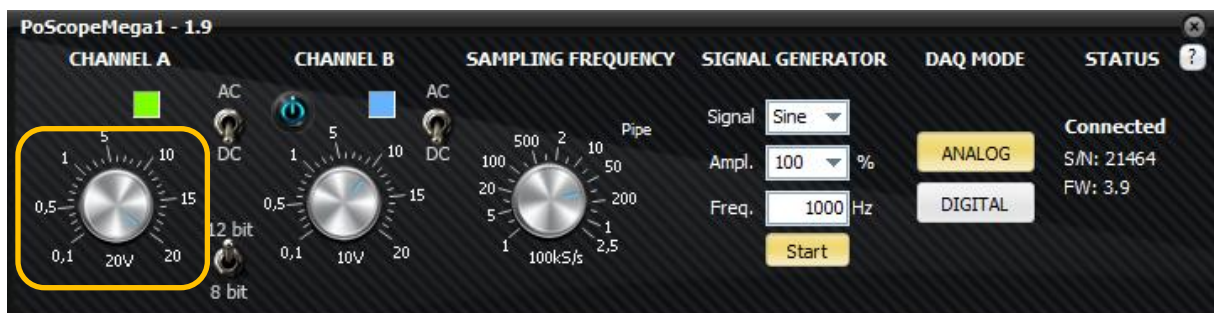

Since the analog generator outputs a voltage amplitude of no more than 2V, you can set the channel A knob to 2V. You will get graphical representation shown below.

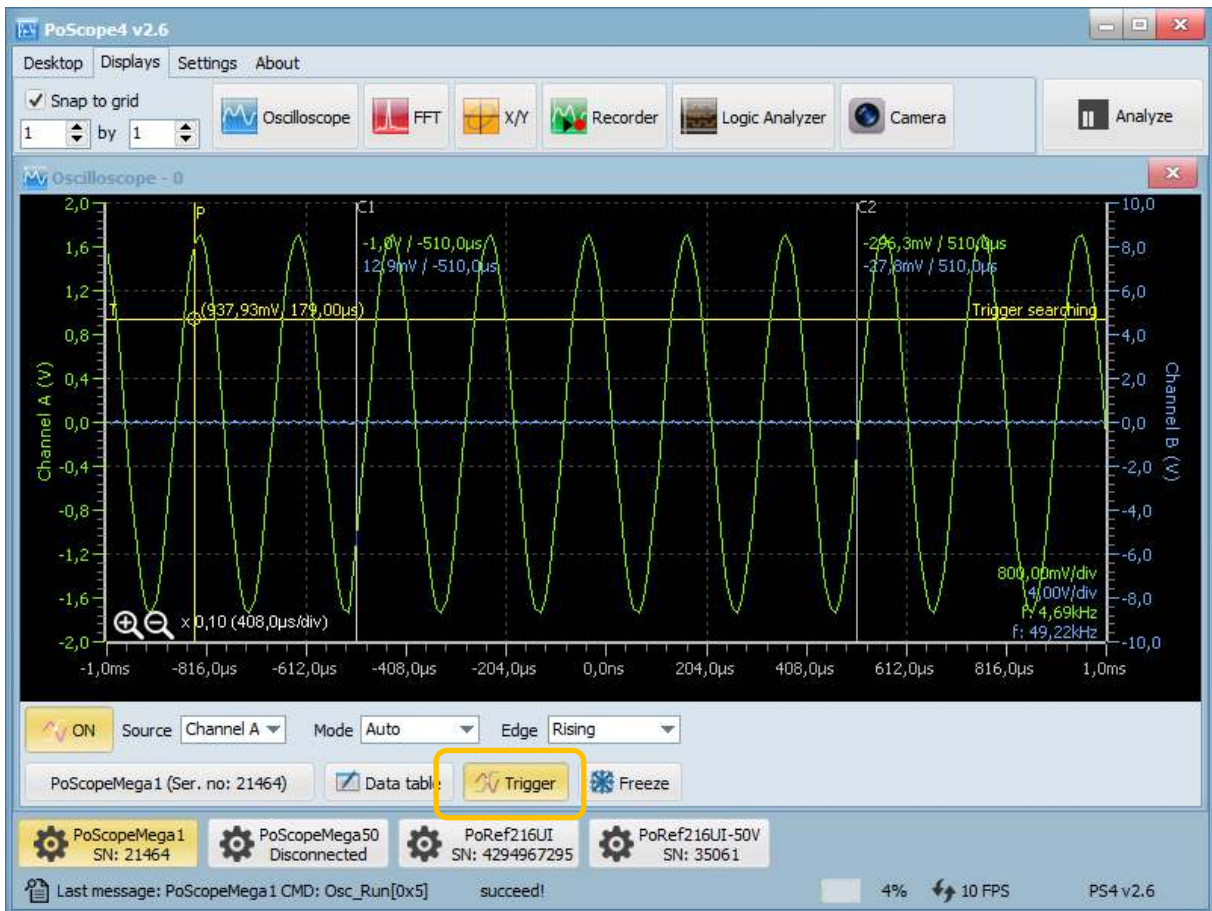

Some signals change very fast. To catch the desired event, you can use **triggering**. **Trigger** is a standard oscilloscope function that allows you to catch the live signal at some particular point so you can closely analyze it. Just choose the correct channel, select Mode (automatic loops or a single trigger) and particular edge of the trigger (signal rising / falling / any).

When you're done with capturing the signal, you can closely examine it. Click **Analyze** in the top-right corner of the PoScope4 software. Waveform will freeze.

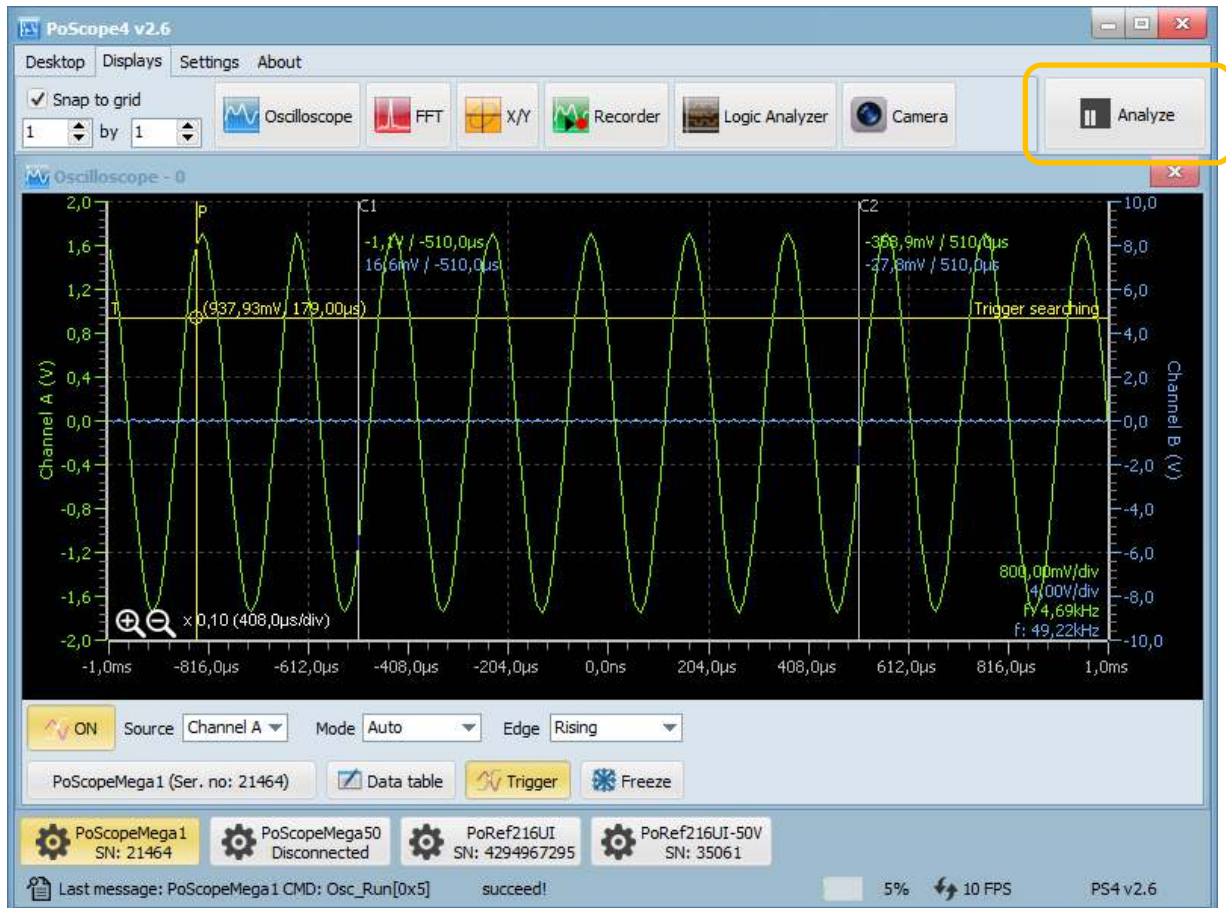

Analyze mode

When pressing analyze additional control with yellow colored selector appears on the top of the waveform. This control is called analyze overview and its purpose is to give users the idea of overall content of data in buffers for further analysis. Data displayed on overview control is ordered by time so the oldest data is left-most and most recent data is right most.

Yellow selector rectangle on overview represents portion of data to be displayed on main chart for analysis. The selector size and position on overview control can be easily modified with few mouse scrolls.

To resize the yellow selector, hover mouse over main chart or overview and use your mouse scroll wheel. To move the waveform, drag and drop with your left mouse button pressed over chart or simply drag selector rectangle on the overview.



Oscilloscope display in analyze mode with Overview window

To read the amplitude of the signal, you don't have to constantly calculate the Volts/div X number of divisions. Just use the 2 vertical cursors available, **C1 and C2**. Find them in your oscilloscope window, click & drag to desired position. Below you will find **Data table** command. It opens small table with current values of voltage amplitude and time difference between C1 and C2.

	C1	Channel A	Channel B
Channel A		342,15mV / 623,05µs	-9,86V / 623,05µs
Channel B		9,87V / 623,05µs	-336,61mV / 623,05µs

Data in data table are voltage and time differences between points on signals under cursors. Let's take an example of value 9,87V / 623,05us. Voltage difference is calculated as: Cursor C1 at Channel A – Cursor C2 at Channel B. Time is just C2 – C1 and it's same for any channel combination.

$C1@ChA - C2@ChA (V) / C2 - C1 (s)$	$C1@ChB - C2@ChA (V) / C2 - C1 (s)$
$C1@ChA - C2@ChB (V) / C2 - C1 (s)$	$C1@ChB - C2@ChB (V) / C2 - C1 (s)$

Value calculations scheme

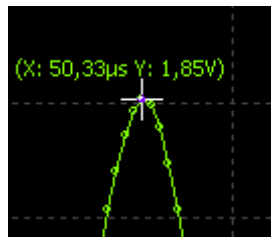

Additionally you can just hover mouse over the signal and cross cursor will show you the value under the mouse cursor.



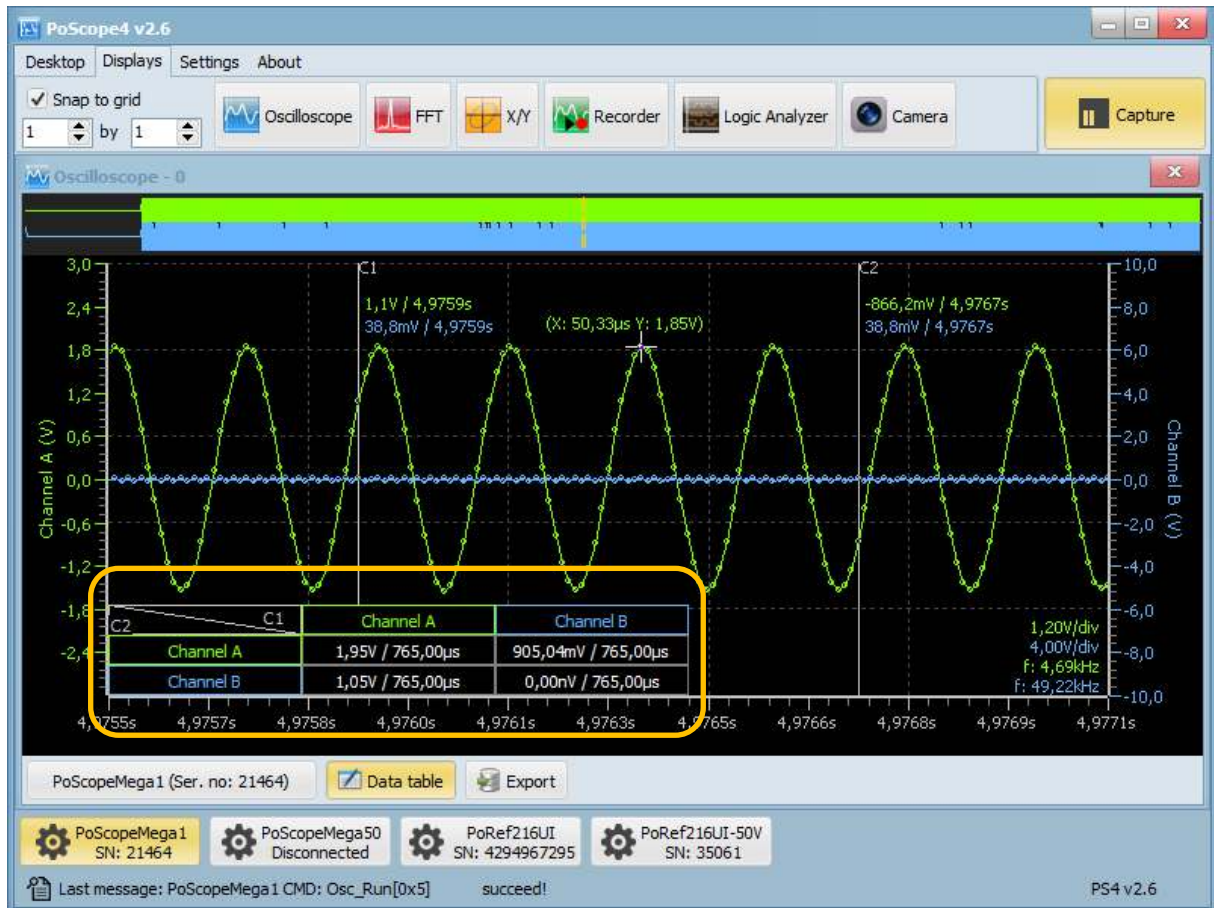

Hint: If you click with left mouse button in the data table you can toggle between time calculation between two cursors and frequency calculation.

In the right-bottom corner you can see estimated frequency calculation. It's an estimation and its accuracy depends on your sampling frequency setting and your signals applied at the inputs. If your sampling frequency is too high and signal frequency is too low the estimated calculation might be wrong.

You can switch between 8-bit and 12-bit mode. 8-bit mode results in higher pipe mode sampling frequency but less accurate data compared to 12-bit mode.

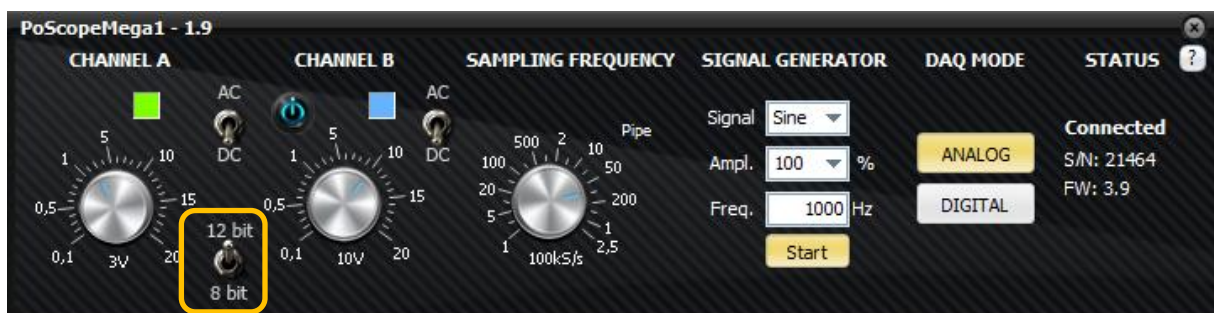

Exporting data

When needed, you can **export** the measured data to external file. Filter out data of interest (channel A, B) and current chart / selected buffer range, and then click Export. Supported file types are:

- .csv,
- .xls,
- .html,
- .pcm - exporting to PCM will create additional txt header file with info (available only for oscilloscope and recorder)



Oscilloscope display in Analyze mode with export settings

PoScopeMega1+ sampling frequency (analog and digital DAQ mode)

If you change sampling frequency knob you will note that label under the knob is changing from Pipe to Buffer. Pipe and Buffer are names for two different data transfer modes.

Data is transferred over full speed USB 2.0 which has speed limitations (1,5Mb/s theoretical). Mega1 can sample faster than we can transfer data over USB thus we introduced these two modes.

Pipe mode: sampling is slower than USB 2.0 “full speed” maximum transfer speed. Device can transfer sampled data over USB 2.0 continuously and without any interrupts

Buffer Mode: sampling is faster than USB 2.0 “full speed” maximum transfer speed. Device is transferring limited amount of data (data images) and there are interrupts between data.

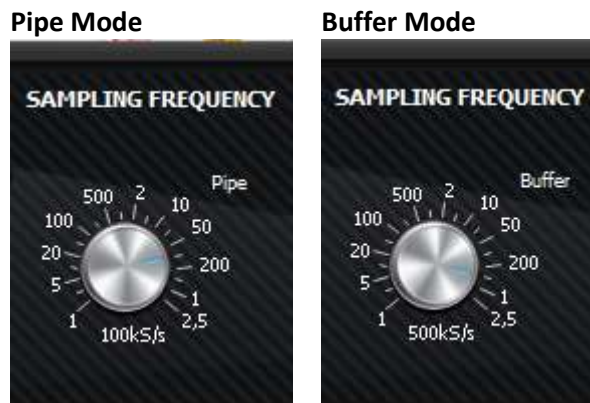

Pipe mode limit is set dynamically, depending on resources used:

- f_s – Sampling frequency [Samples / second]
- N – Count of used channels [n] (is channel B on?)
- S – size of one sample in bytes [bytes] (8-bit / 12-bit)
- V_{usb} – USB 2.0 “full speed” maximum transfer rate (1,5 MB/s in theory)

$$f_s \times N \times S < V_{usb}$$

PoScopeMega1+ maximum pipe mode sampling frequency is:

- 12 bit mode and two channels: 200kS/s,
- 8 bit mode and two channels: 200kS/s,
- 12 bit mode and single channel: 500kS/s,
- 8 bit mode and single channel: 500kS/s.

When Channel B is turned off, the Mega1+ maximum buffer mode sampling frequency is 2,5MS/s (single channel only).

Using multiple devices in PoScope4

Sometimes there is a need to measure more than 2 analog signals. PoScope4 supports multiple devices and multiple instances of same type of device. Each device gets its own control GUI.

When you have more than one Mega1+ (or any other supported devices) you can set up PoScope4 to load multiple instances of Mega1+ by clicking **Settings** button in main menu.

In window which appears, click on the Device instances tab and select how many instances of each device would like to have.

Select appropriate number and restart PoScope4. New buttons will be added to the devices toolbar in the bottom. Each instance of control GUI will detect when device is attached to computer and connect to it.

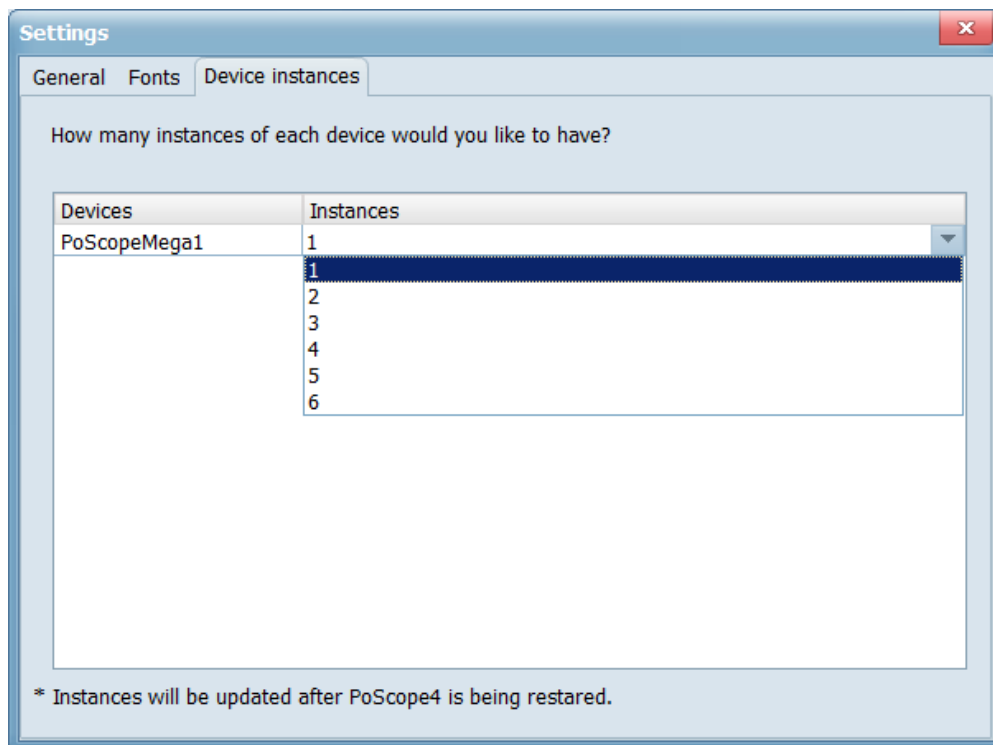

Device instances setting

Synchronization issue

It is possible to connect two or more devices to PoScope4 but you cannot use them on the same display while devices don't have common sync clock used for sampling. Each device has its own clock and doesn't offer external clock synchronization feature therefore data cannot be properly synchronized between different devices. Those devices can still be used on separate displays.

X/Y SCOPE

There are applications where we need to know phase differences between two or more varying voltages. Oscilloscope can be used to track phase differences between multiple input signals. X/Y scope plots them out as one voltage versus another. If input signals are periodic resulting curves are called **Lissajous figures**. We can use this tool in different fields:

- component characteristic (I-V curves),
- broadcast engineering (stereo – left/right),
- audio amplifiers (distortion between in & out),
- guitar tuning,
- etc.

For this example we need 1 oscilloscope (PoScopeMega1) and 2 voltage sources. Analog generator is a standard feature of Mega1 oscilloscope, but since it's a single-channel, we need 2 of Mega1 devices. In order to use multiple devices in PoScope4, go to Settings and set a higher number of device instances.

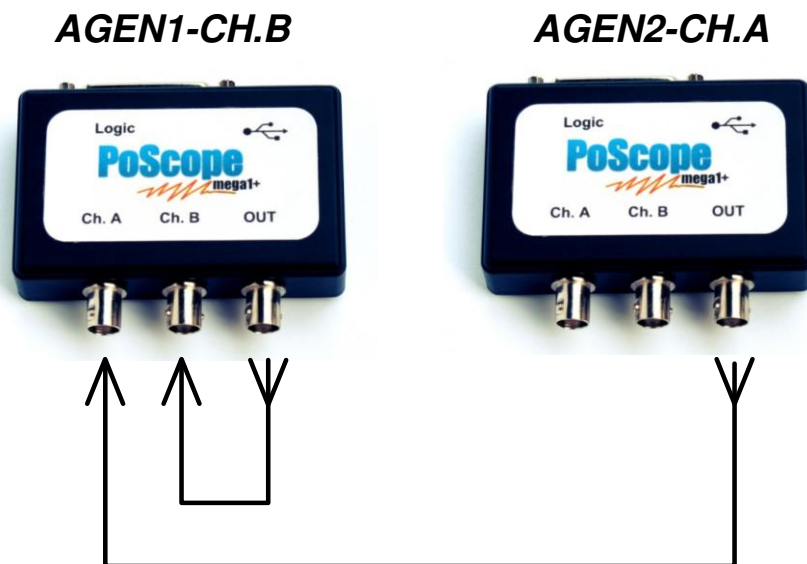

You can open the X/Y scope by clicking its icon in the DISPLAYS tab of PoScope 4 software:

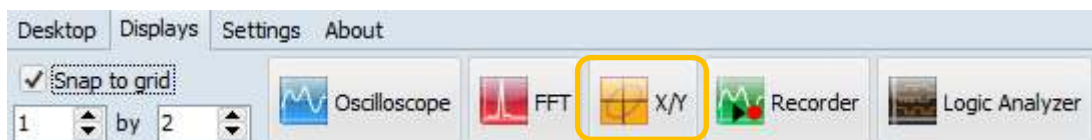

You might come across this window. In order to track phase differences, both of the channels have to be active. You have to turn on the signal on channel B on the Mega1 device control GUI.

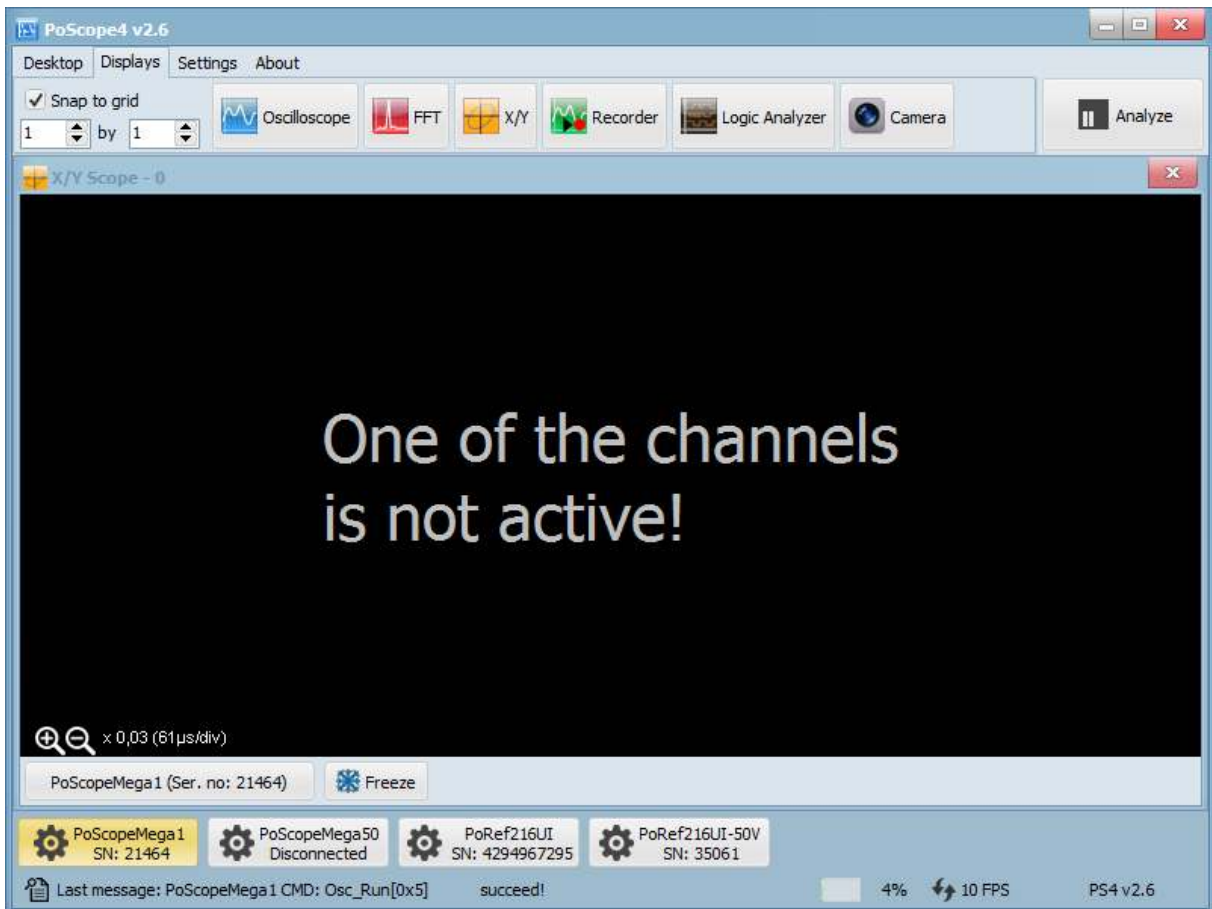

"One of the channels is not active" error message in XY mode

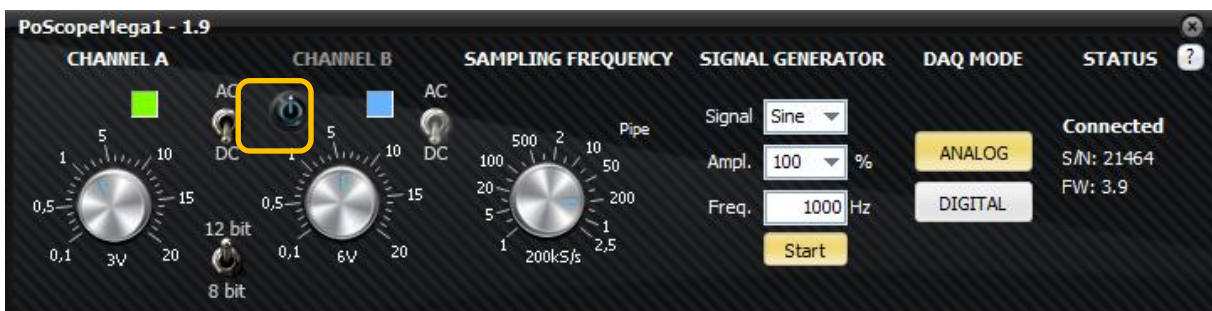

Channel B on/off button on Mega1 device controls

In order to see the phase differences, you can open oscilloscope display and enable the trigger function on one of the channels. One of the signals will freeze, the other will move across the display in relationship to the first one.



Now let's draw some basic Lissajous curves. If we set ratio of frequencies to 2:1, for instance 5kHz on channel A and 10kHz on channel B, we get following curve.

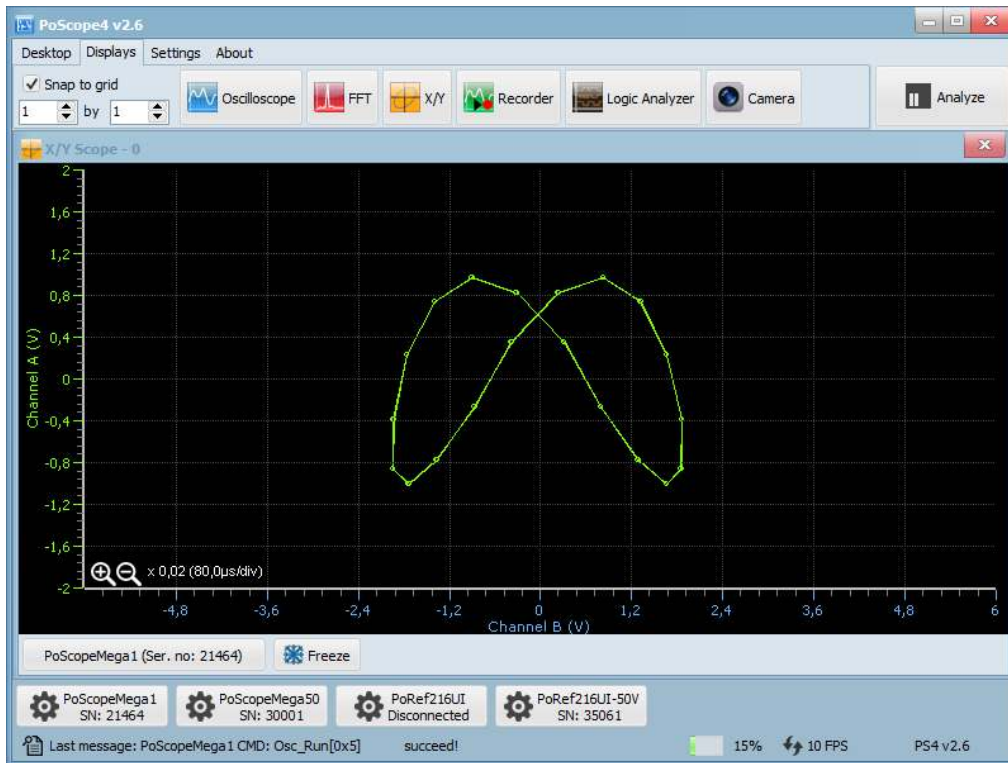

Lissajous curves at frequency ratio 2:1

When we change the ratio to 1:2, for instance to 10kHz on channel A and 5kHz on channel B, the curve rotates by 90°. At greater ratios we just get more twists.

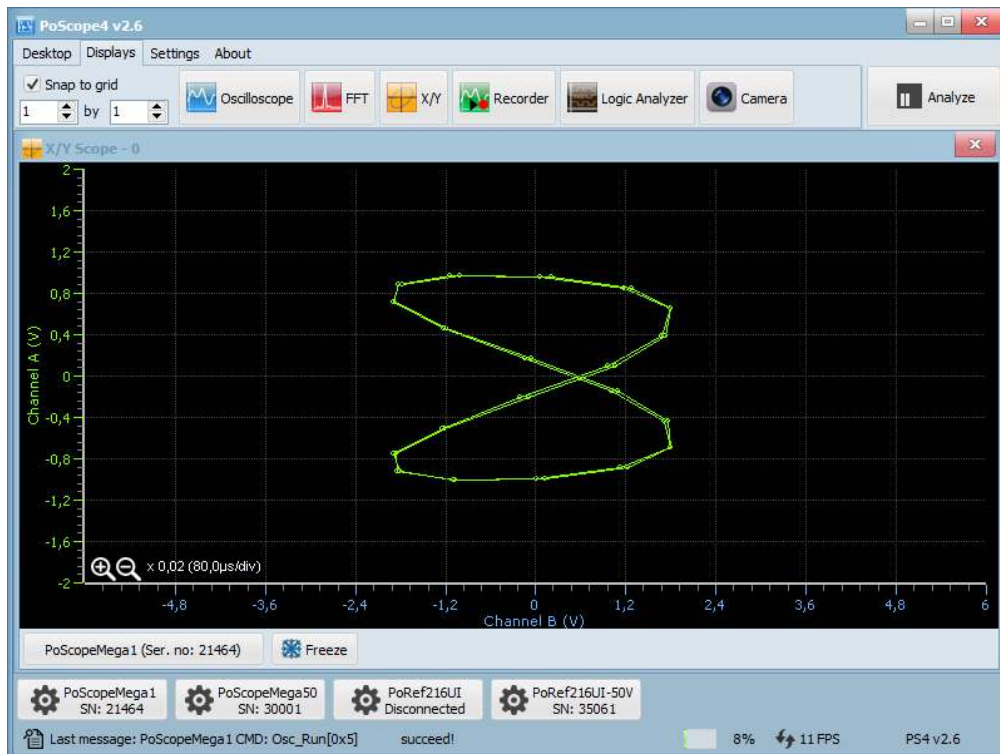

Lissajous curves figure infinite at frequency ratio 1:2

When there is 90° phase shift between the two signals the XY display draws a circle.

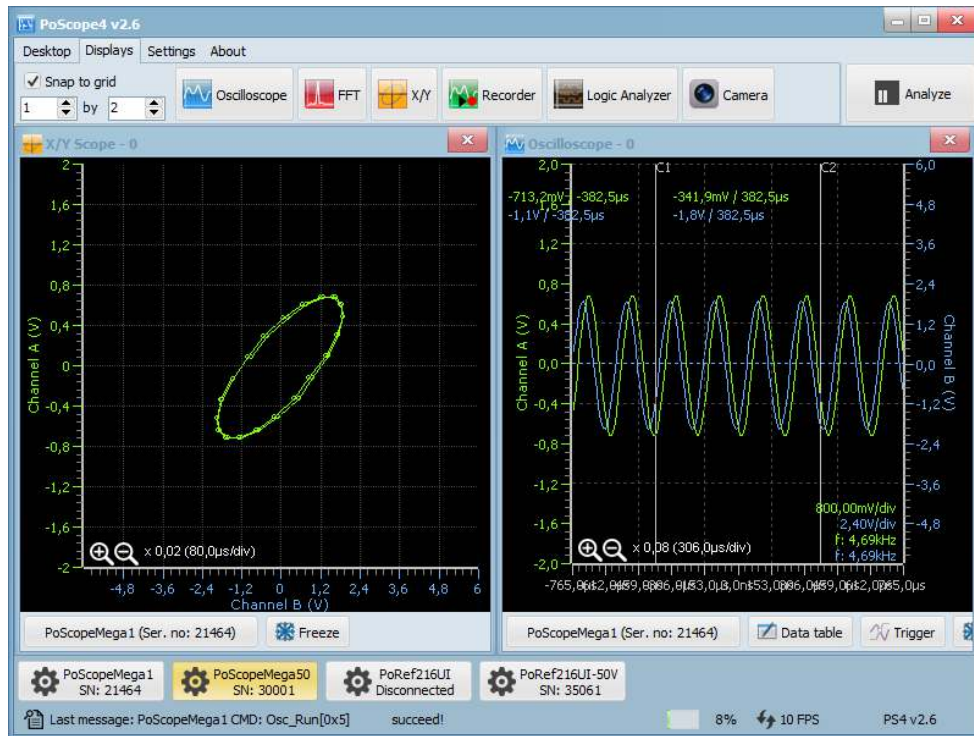

There are many different examples of Lissajous curves. Let's switch shape of one signal to triangle.



Channel A is triangle and Channel B is sine

SPECTRUM ANALYZER

Spectrum analyzer measures signal amplitude over wide range of frequencies. It plots a waveform of signal amplitude (Y axis) against frequency range (X axis). With spectral analyzer you can find out the dominant frequency of a known signal and the amplitude / frequency of the unknown or undesired signals, as well as signal's other spectral components (power, distortion, harmonics, bandwidth, etc.)

PoScope4 uses **Fast Fourier transformation** (FFT) for a frequency analysis of an electric signal. It is a mathematical process that is used to transform a waveform into the components of a signal's frequency.

Spectrum analyzer can be used for variety of tasks, including:

- finding dominant frequency
- searching for signal interferences
- characterization of electronic devices
- benchmark testing
- detecting unknown signals
- EMC testing.

With appropriate transducers, you can even measure non-electric frequencies, such as in audio or visual applications.

You can open the spectrum analyzer by clicking the Frequency analyzer icon in the DISPLAYS tab of PoScope4 software:

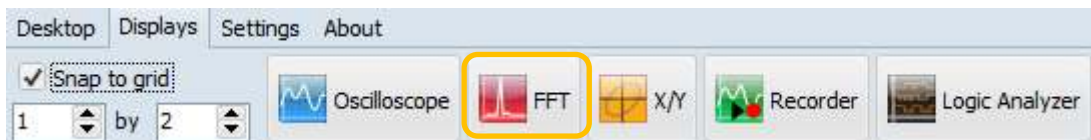

Waveform below shows frequency spectrum of periodic signal coming from analog generator. Frequency of the signal is set to approximately 10 kHz. Waveform is being plotted as signal amplitude (Y axis) vs. frequency (X axis). Clicking Axes gives you additional set of settings to examine frequencies of the input signal.

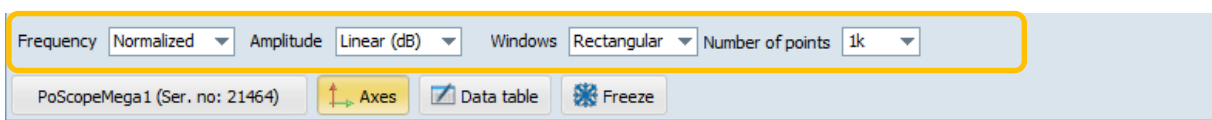

Frequency	Amplitude	Windows
linear	linear	rectangular
logarithmic	linear (0 dB)	Hanning
normalized	linear (0 dB max)	Hamming
	normalized	Flat top
		Triangle
		Blackman
		Blackman Harris
		Exponent Down

In the Frequency analyzer, cursors are also available. Drag and drop them with your mouse to find out which frequencies are most dominant. To view the relationships between C1 and C2, click on the data table.



Frequency analyzer with data table open

Click on Analyze button will take you to Analyze mode. In analyze mode the overview control will open. You can resize the yellow selector by hovering your mouse over it and use the scroll wheel to make the yellow square smaller. When done, you can pan the waveform left and right to make a FFT analysis over selected part of buffer. In Analyze mode, you can also export the data to various formats of an external file. To return to live signal, just click on Capture mode button.



Frequency analyzer in Analyze mode with Overview window

RECORDER

Analyze button is limited with the amount of RAM memory installed in a workstation where measurements are taken. To avoid the limits of RAM memory, you can save measurements to an external file on your disk. Therefore the total amount of measuring samples will be limited with the total capacity of your hard drive, SSD or USB drive.

To run the recorder module of PoScope 4 software, click the REC icon in the device functions area of PoScope 4 software.



Standard oscilloscope window opens, offering you record button below to start recording.



REMARK: Record button is visible only if source device is in **PIPE MODE**. Recording is not possible in **BUFFER MODE**.

Acquired samples can be recorded to **PoScope4 recorder file** or **PCM file** (pulse-code modulated data). PCM is intended for use in 3rd party software, therefore it can't be open in PoScope4 application. Recording to PCM will create additional txt header file with following info:

- number of channels,
- data size per channel,
- bit ordering,
- sampling frequency etc.

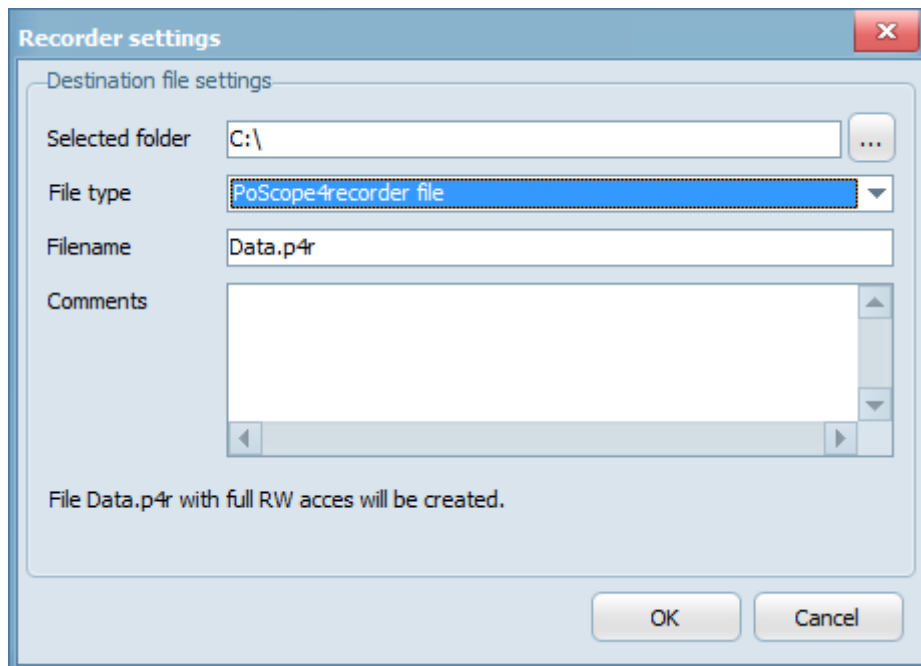

Recorder settings

Once recording, you can stop it by pressing recording button again. The PoScope 4 recorder file can be open in PoScope 4 application. Click to the source and select Open file. Find and open the PoScope 4 file on your hard drive.

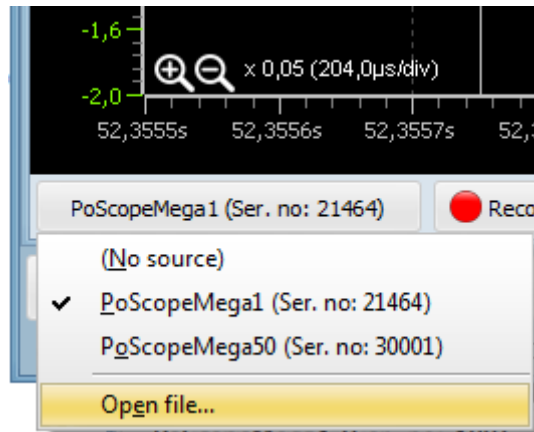

Once open, you can switch pages and resize the overview selector. If you hover over the waveform you can change the timebase using mouse scroller and drag the waveform left and right using you left mouse button. Data table and export features are also available as in the oscilloscope display.

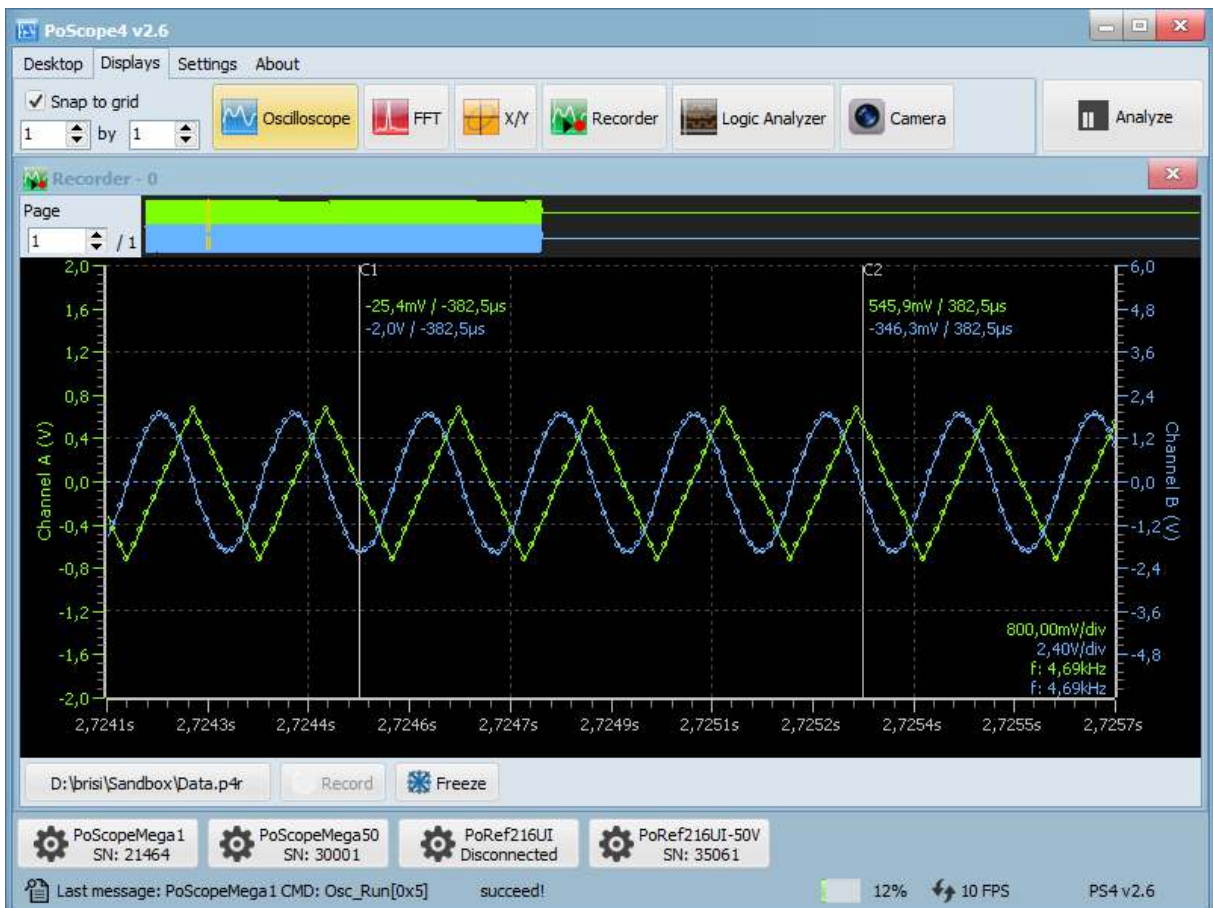

LOGIC ANALYZER

Logic analyzer is an electronic measurement instrument, capable of capturing and displaying multiple signals from a digital circuit. With this powerful tool you can observe many digital signals at the same time and perform exact time measurements. It is useful for various tasks in electronics design, testing and repair:

- analyze timing errors,
- verify timing diagrams,
- observe timing relationships among many signals,
- decode the information on buses,
- view state machine traces.

With PoScope Mega1+ you can simultaneously display, capture and analyze up to 16 digital channels varying from 0 to +5V.

For this example we used our PoKeys I/O device. PoKeys is a powerful little device with extensive amount of functions. You can program it with easy-to-use graphic tool, the PoBlocks. We used PoProbe to tap into its outputs, also available in our web store.

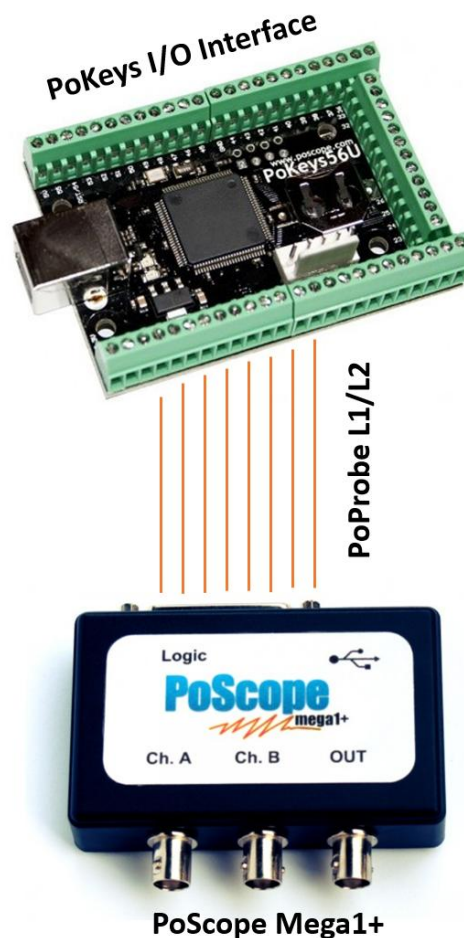

Logic analyzer measurements on PoKeys I/O controller

Run the **Logic Analyzer** by clicking its icon in the **Displays tab** of PoScope4 software:



Below you can see an example of displaying digital ports of a PoKeys input / output device. As in oscilloscope mode, you can click **Analyze** button to closely view the captured data.

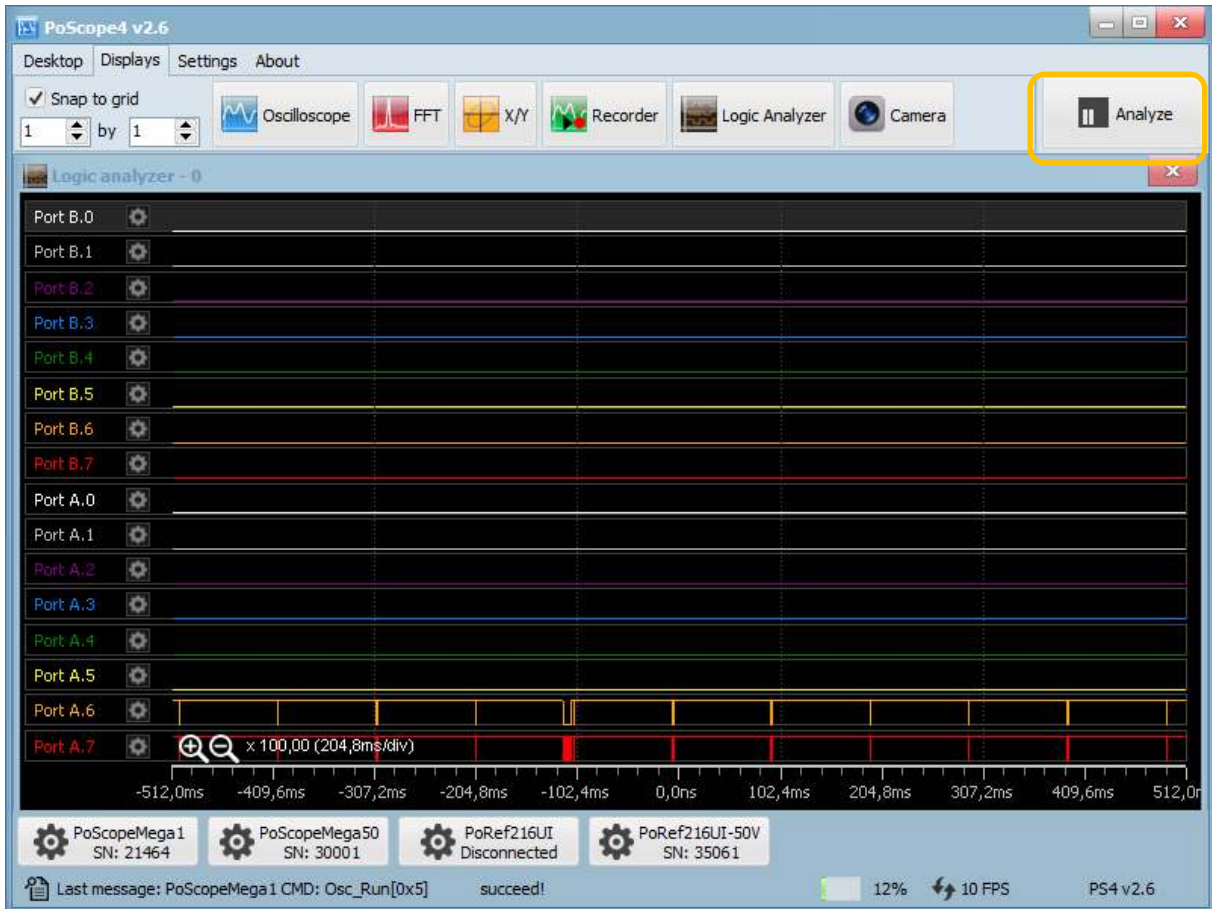

Logic analyzer waveforms

When in Analyze mode, use the yellow selector above to select the part of captured data for even closer observation. Resize the yellow selector with scroll wheel and drag it to point of interest.

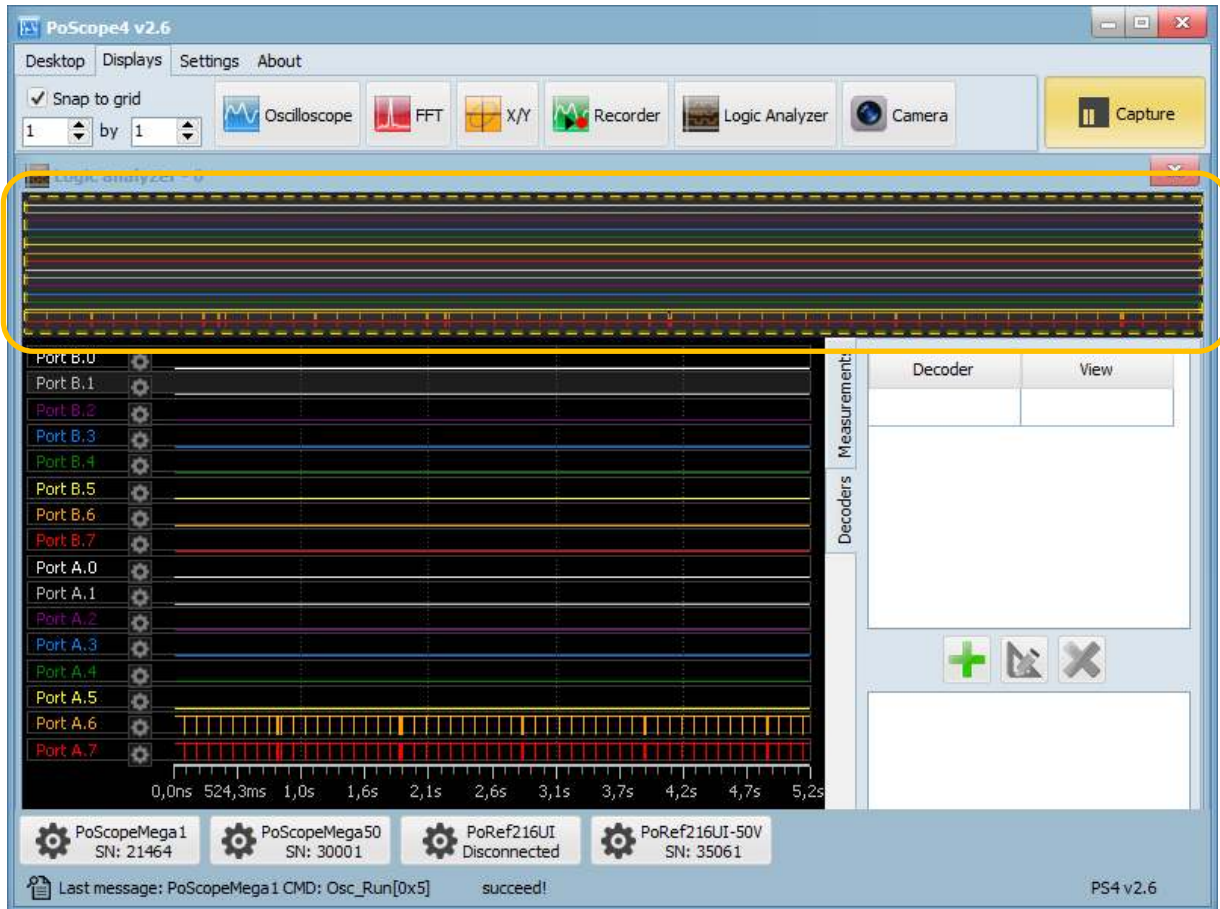

Logic analyzer in Analyze mode with Overview window open

On the right side of the Logic analyzer display you will find 2 tabs. Under measurements you will find width, frequency, period and duty cycle. Values will change as you hover over the diagram.

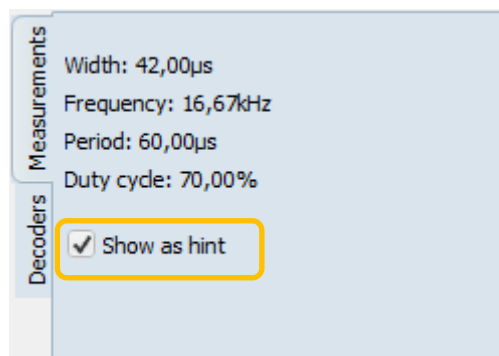

Logic analyzer measurements pane

When done, you can hover over the part of the certain square waveform to see additional details.

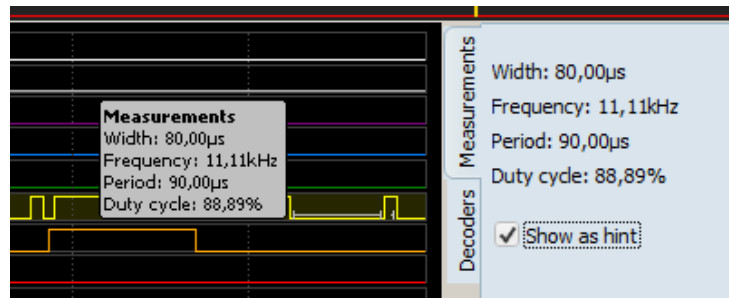

You can export the data selected in overview window to an external file in various formats.

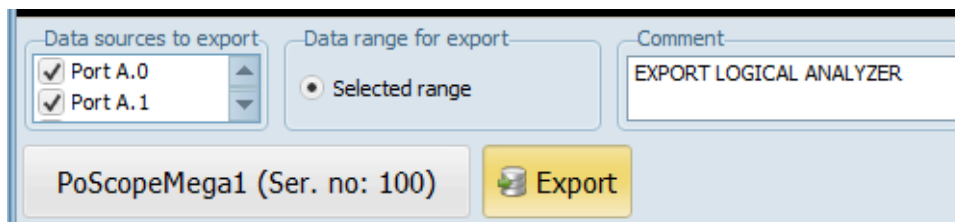

Logic analyzer export settings

Every channel can be switched off/on simply by selecting it in a Windows manner. Click on Port A.6 and hold CTRL then click on Port A.7. Both channels are now selected. Now click on channel settings icon (any). Popup menu will show you options what to do with channels. You can show all channels if any are hidden. You can also hide one of selected channels by clicking Hide this channel or you can hide all other unselected channels. In our case we click Hide unselected channels.

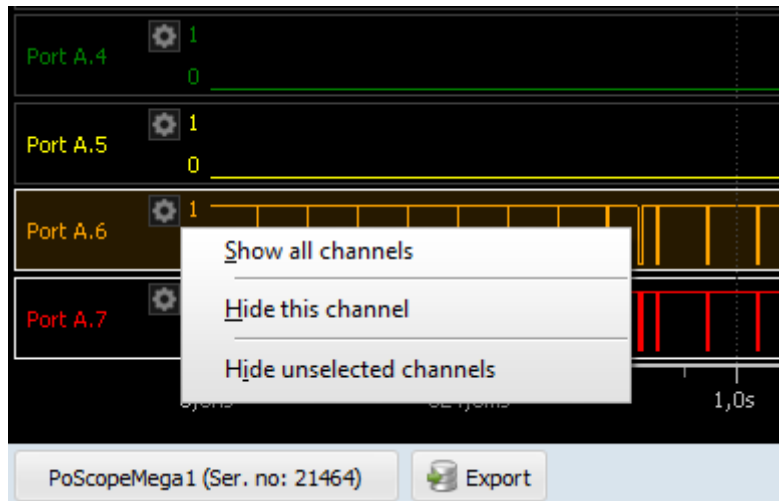

Now overview and main chart will be updated and only Port A.6 and Port A.7 channels will be visible.



Hint: By double clicking on channel names one can rename channels.

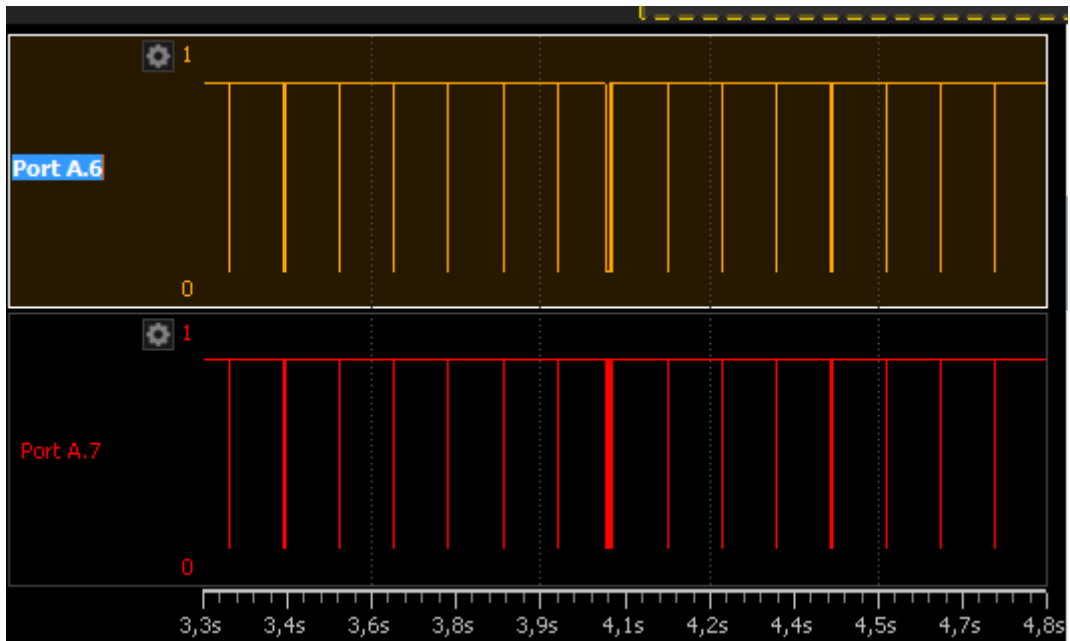

I2C DECODER

Inter – integrated circuit simplifies the hardware part of electronic devices. It consists of only 2 wires. One is used for clock synchronization, the other one is for data transfer purposes. On each I2C bus you will find one master and multiple slaves. Most I2C busses work on frequencies up to 100 kHz, which can go higher if needed. I2C mostly uses 7-bit addresses which are actually 8-bit because the first bit describes whether the Master is reading or writing to the slave address. Mega 1 has the ability of decoding 8 I2C busses. Each bus can hold up to 128 devices, therefore the Mega 1 can connect up to 1024 devices.

To see how I2C decoder works, you can use our PoKeys controller, connect it to PoSensors board and tap into the clock and data lines of i2c bus. They can be connected to any input of the logic analyzer port.

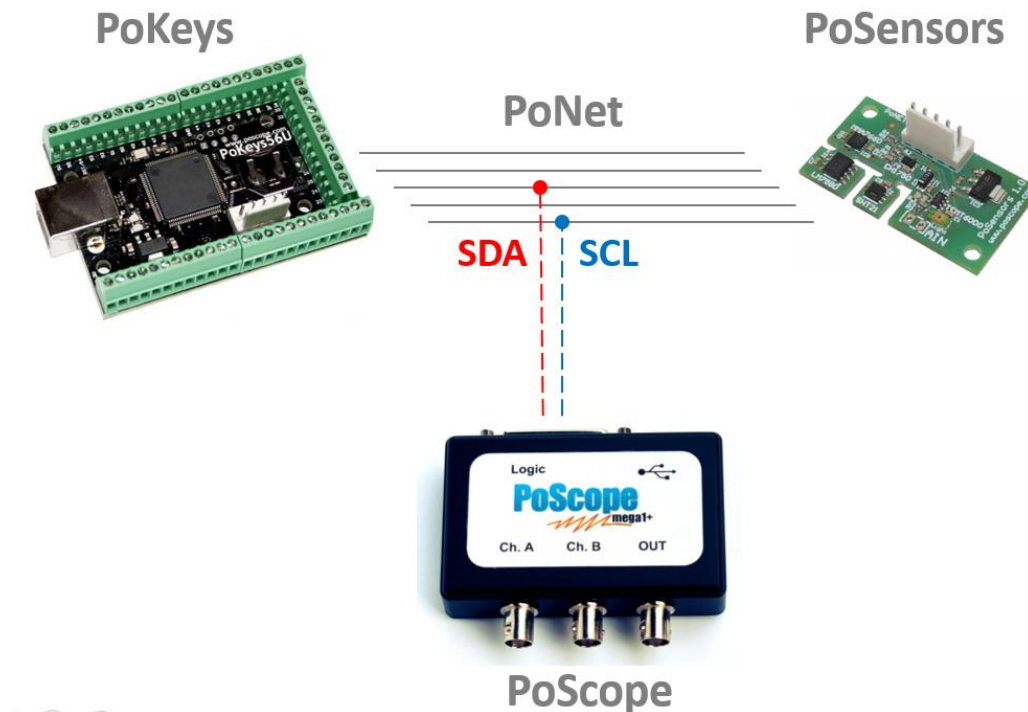

Connecting PoScope Mega1 I2C decoder to PoSensors

To decode an I2C bus, go to PoScope 4 application. With device set to digital mode and logic analyzer display open, click the Analyze button. In order to assure quality measurements, note that sampling rate has to be higher than the signal frequency / bus clock rate. I2C is by default 100kBits/s (different speeds are supported) so we suggest you to setup sampling frequency to 500kS/s and set PoScope4 for capturing. After a second or so (so the buffers will be full) press Analyze button to switch to analyze.

Use the overview yellow selector and mouse scroller to select part of data for analysis and decoding. Pin that has most dense pulses is usually the clock. You can also rename Pin by double-clicking its name. The second pin is data.

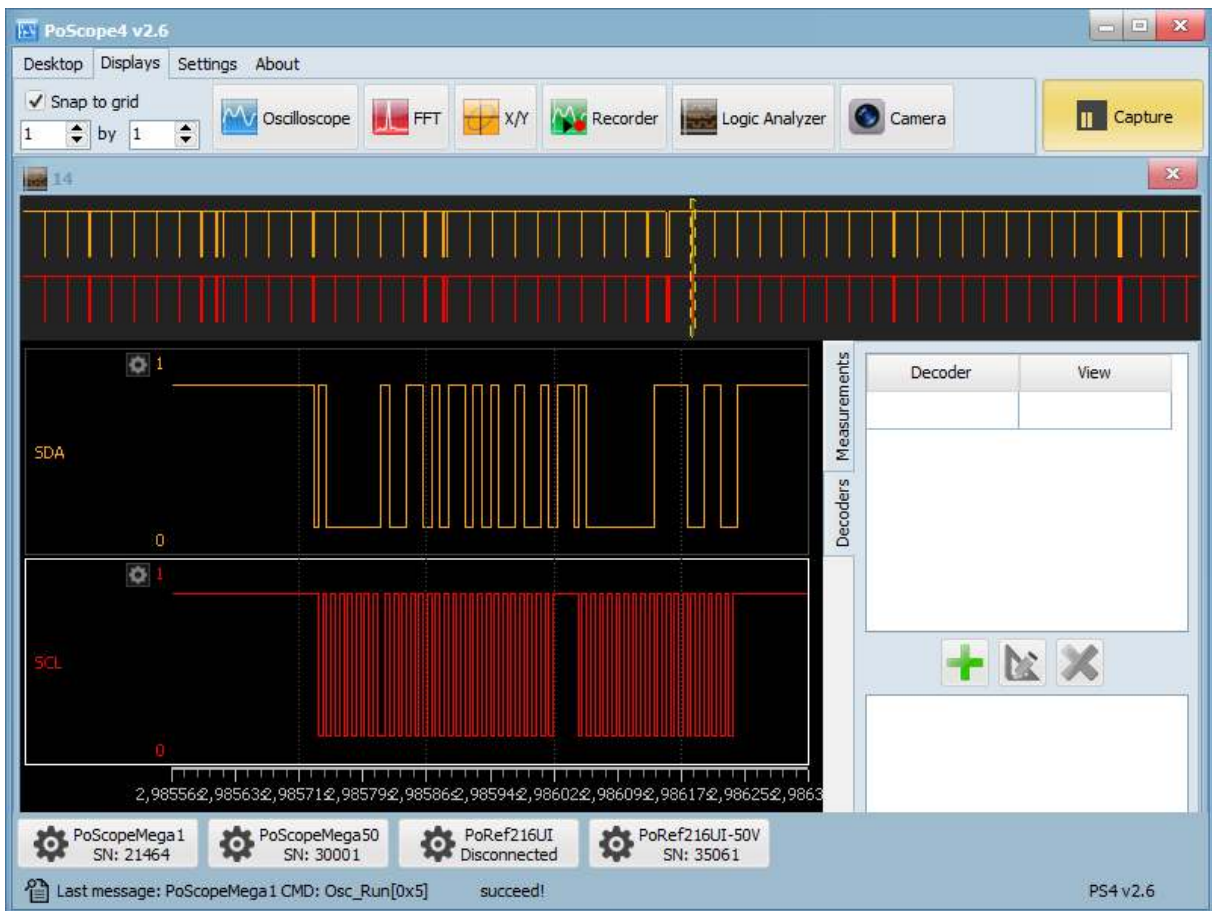

I2C decoder clock (SCL) and data (SDA) lines

To add I2C decoder, click the + button on the I2C panel under Decoders tab.

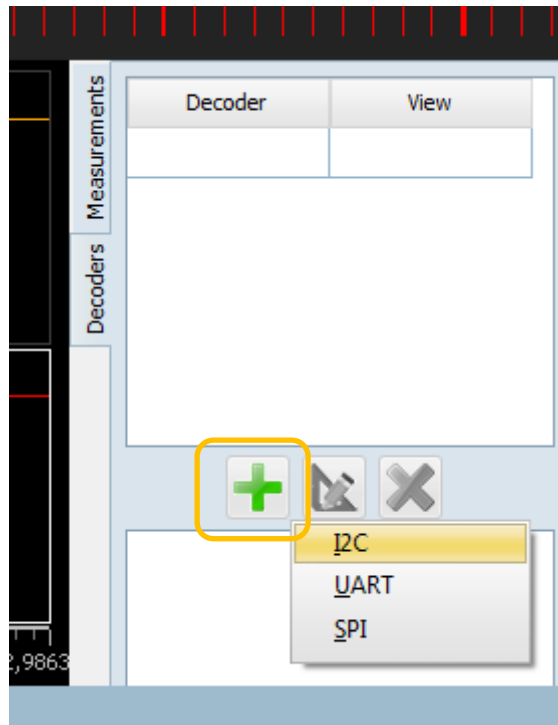

The application offers the data (SDA) and clock (SCL) parameters and how many bits to show the slave addresses. Additionally there are supported many I2C devices you can choose among such as SHT20, SHT21, SHT25, STS21, HTUA21A, HTU20D, HTU21D, HTU3800, Si7006, Si7006, Si7020, Si7021 and Si7013.

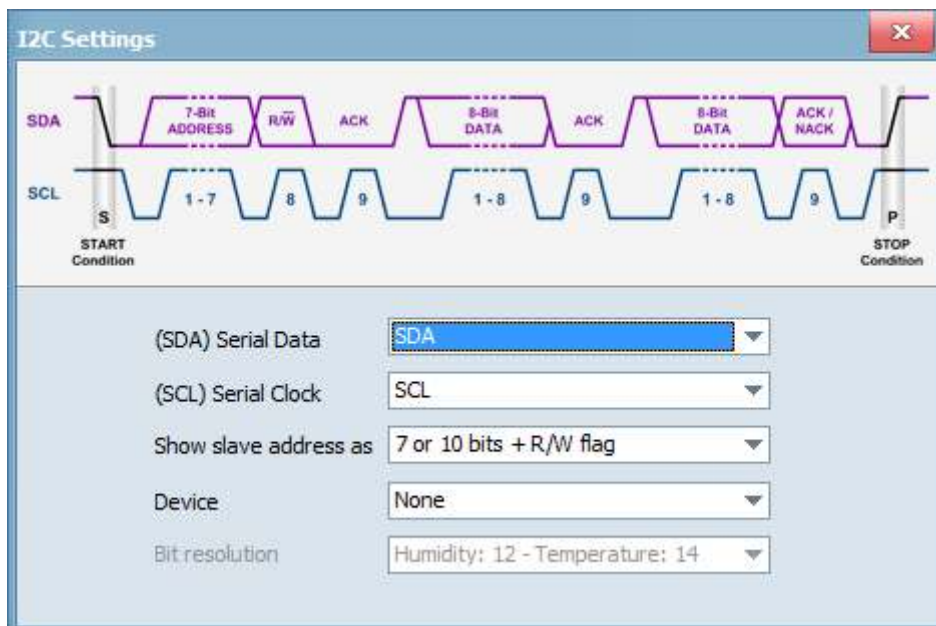

If you name your pins as I2C standard names (SCL, SDA) the decoder settings window will automatically recognize lines and use them for decoding otherwise you have to manually select pins for data sources.

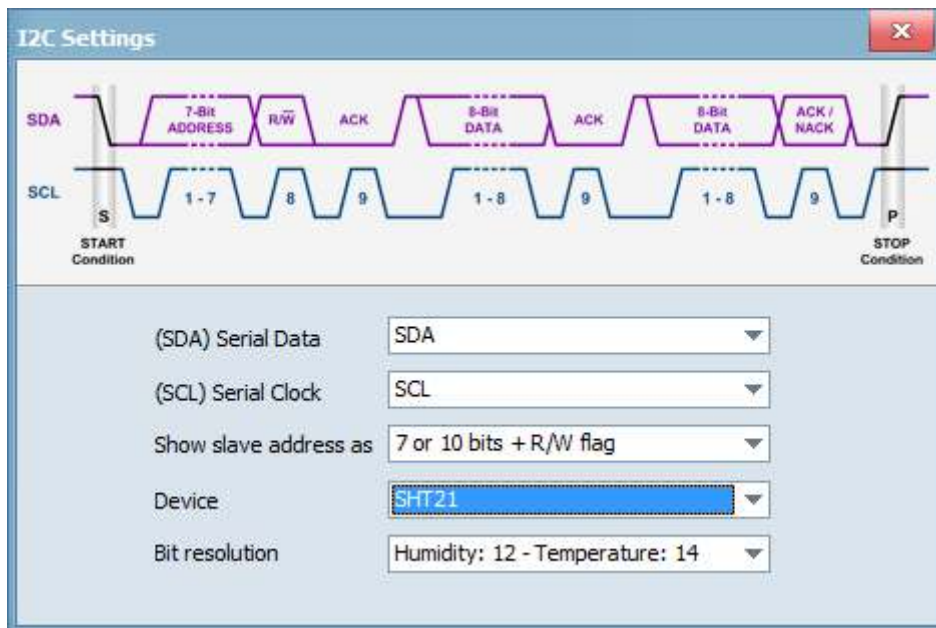

I2C Settings window

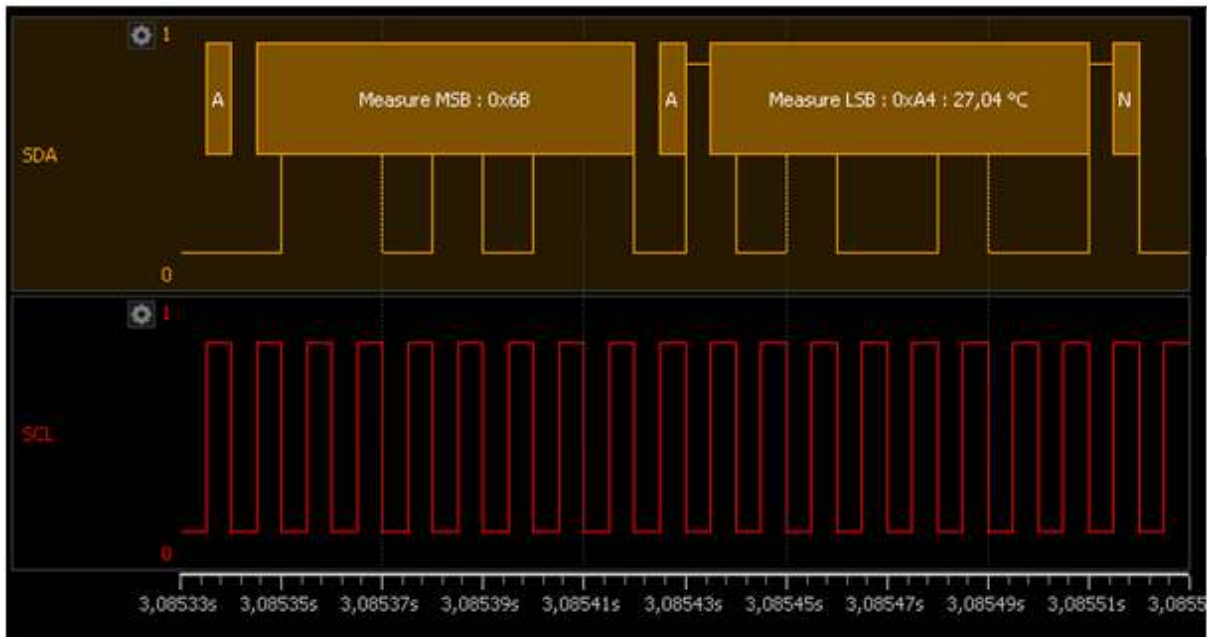

SHT21 sensor decoding

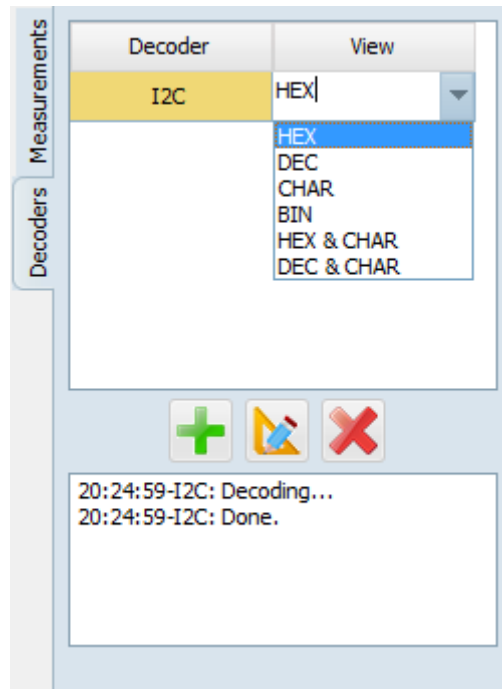

Under the View, you can select how you want the decoded data to be shown. HEX, DEC, CHAR, BIN, HEX & CHAR, DEC & CHAR are available. Measurements can be shown in the side panel or as a hint when you hover the mouse cursor over the I2C data.

In the display window you can see:

- The start bit,
- Master read initialization,
- The address master wants to read from,
- The acknowledge bit,
- The transferred data and
- The stop bit.

On places where you see little squares, there is not enough room for displaying full package description. If you hover your mouse over that square, hint will show its full description.

UART DECODER

We are introducing UART protocol decoder.

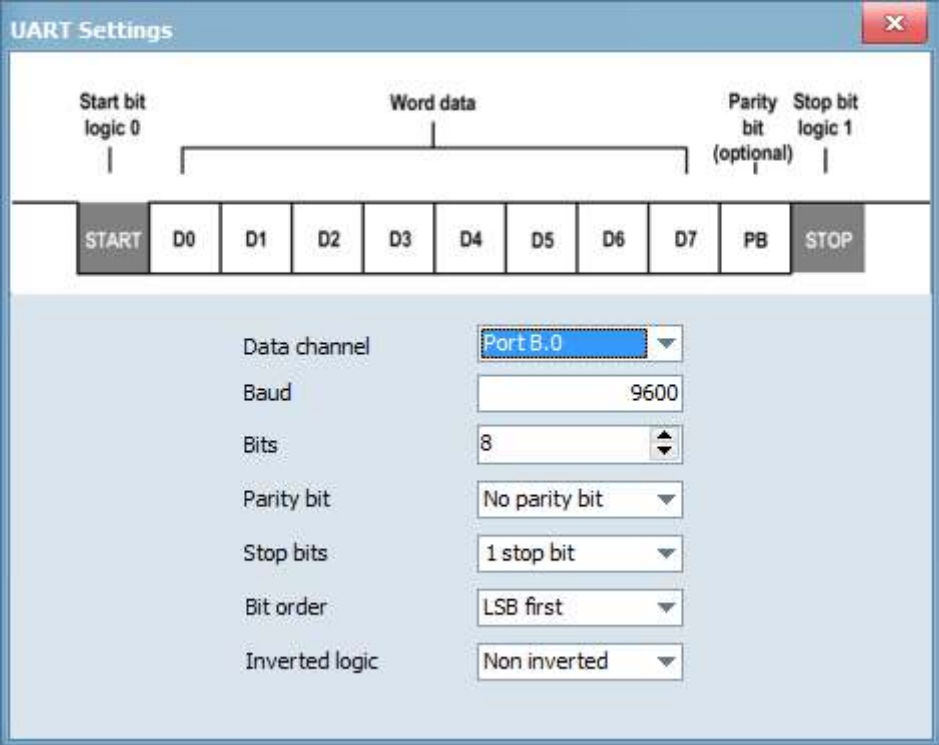

UART protocol decoder settings dialog

SPI DECODER

We are introducing SPI protocol decoder.

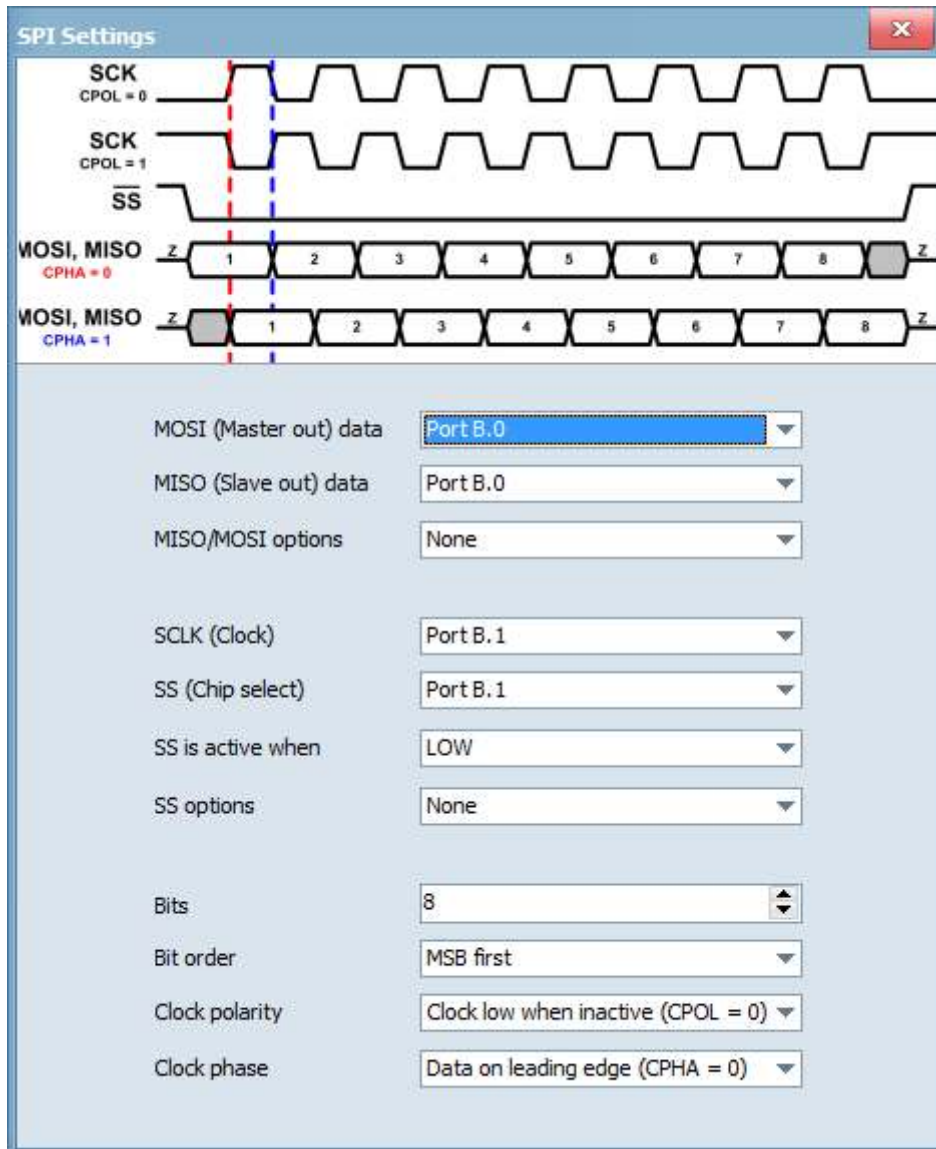

SPI protocol decoder settings dialog

FUNCTION GENERATOR (Only for Mega1+ and Mega50 devices)

Function generator is capable of generating different types of periodical electrical waveforms over a wide range of frequencies, limited to **12,5kHz**. It can generate **sine, square, triangle and saw**, showed below. Function generator can be used in development, test and repair of electronic equipment, e.g. it can be a signal source to test amplifiers. Analog generator can be used only when device is set to analog DAQ mode.

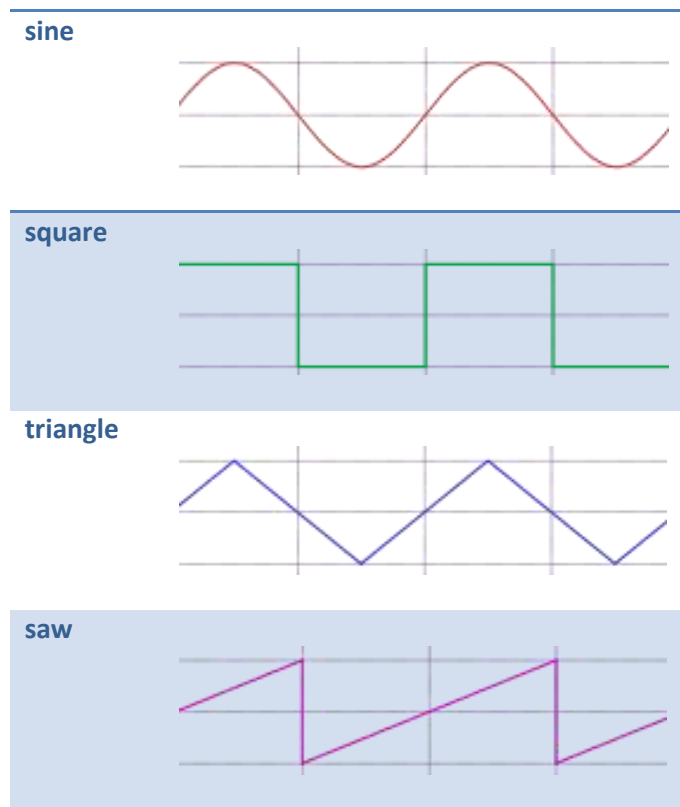

To show you the basic use of function generator, we connected two probes to the PoScope Mega1+, first one to the function generator output and the second one to oscilloscope channel A. We connected the signal and the ground connections of the two probes and ran the function generator at 5 kHz.

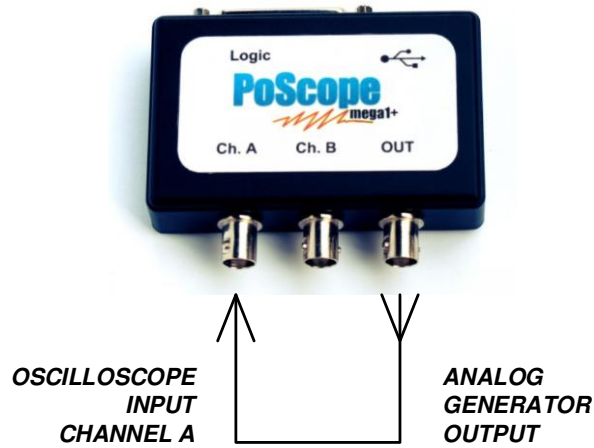

Open the PoScope Mega1+ control GUI by clicking its icon in device buttons area of the PoScope4 software.



Find the analog generator controls on the right half of the Mega 1 control GUI. Besides shape of the signal (sine, square, triangle, saw) and its frequency (limited to 12.5 kHz) you can also set its amplitude, expressed in % of 1.8Vpp.

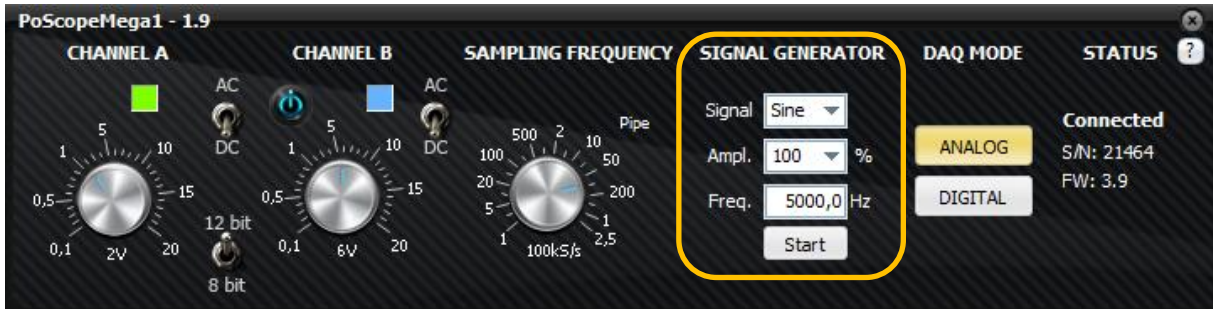

The waveforms on the oscilloscope display will change according to the shape of selected signal on the analog generator part of the Mega1 controls.

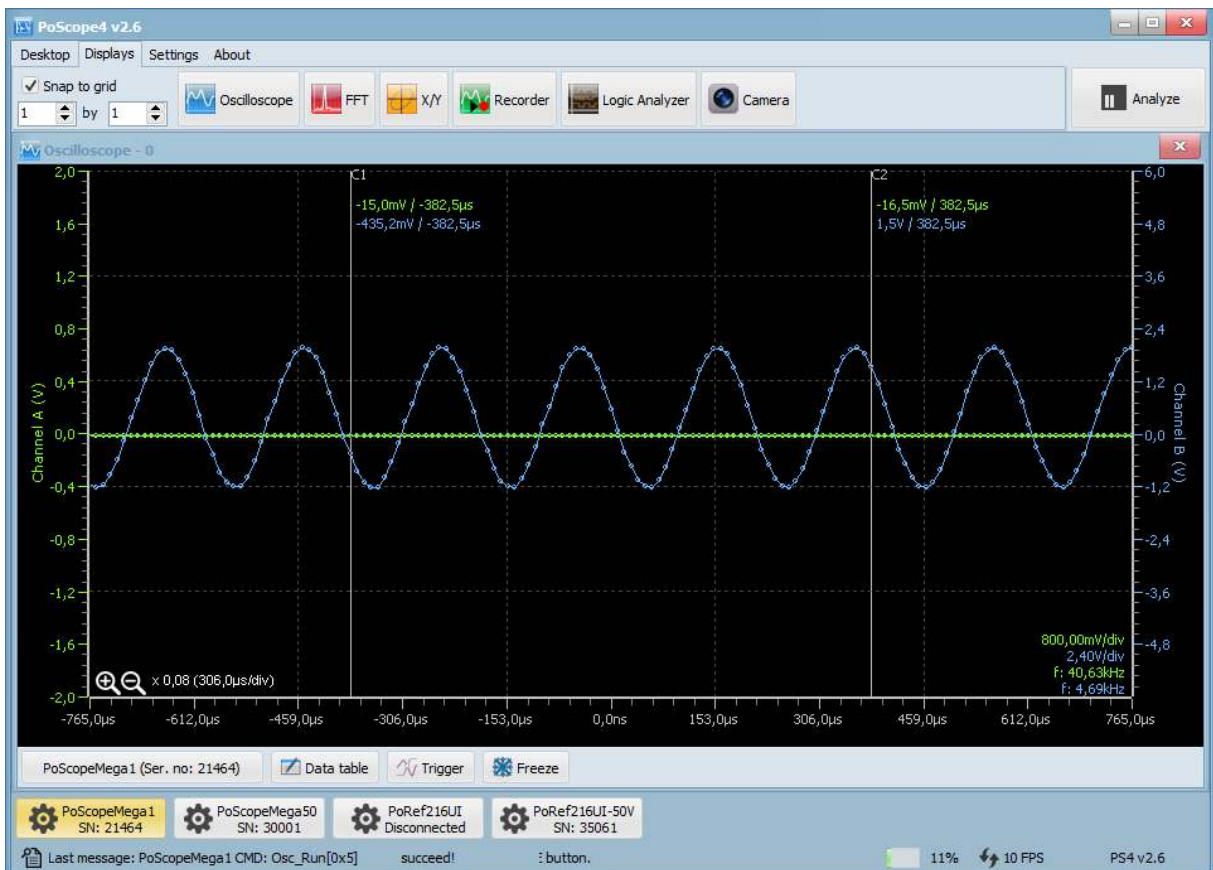

Signal generator's sine waveform

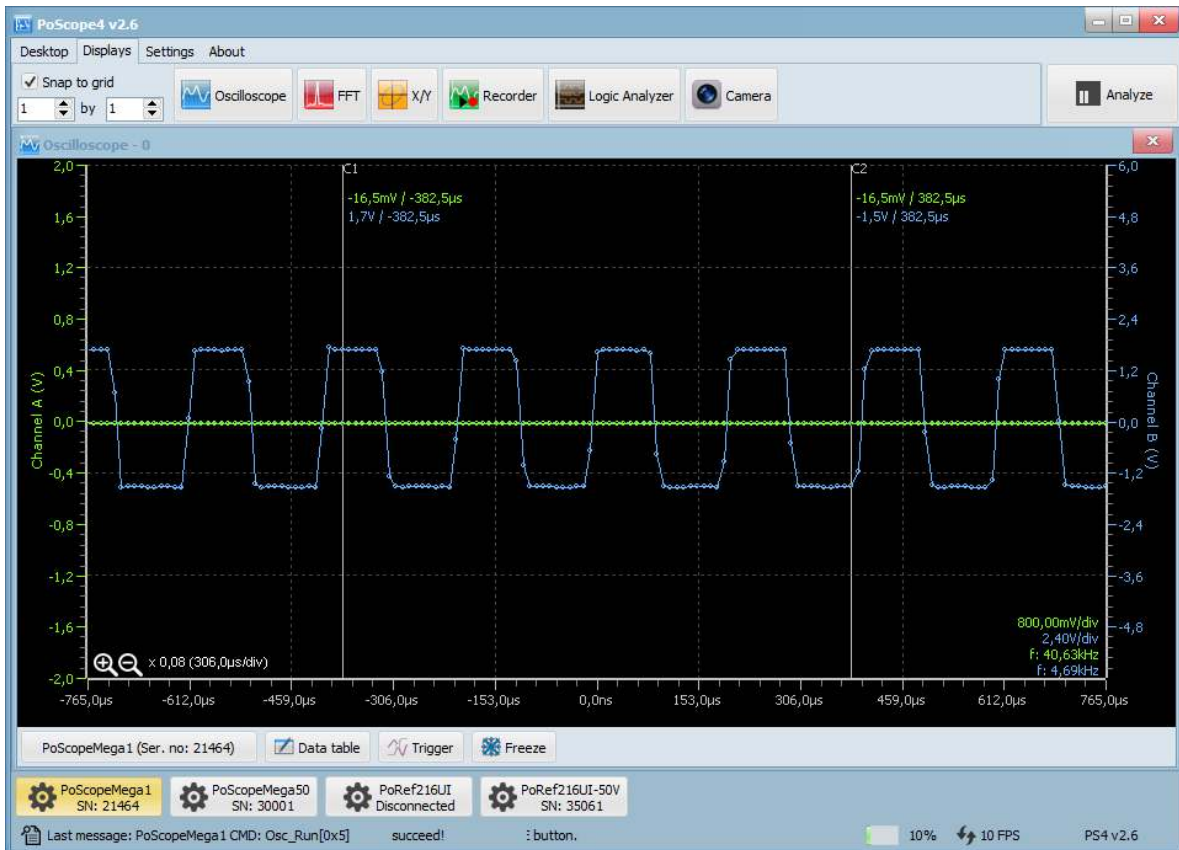

Function generator's square waveform

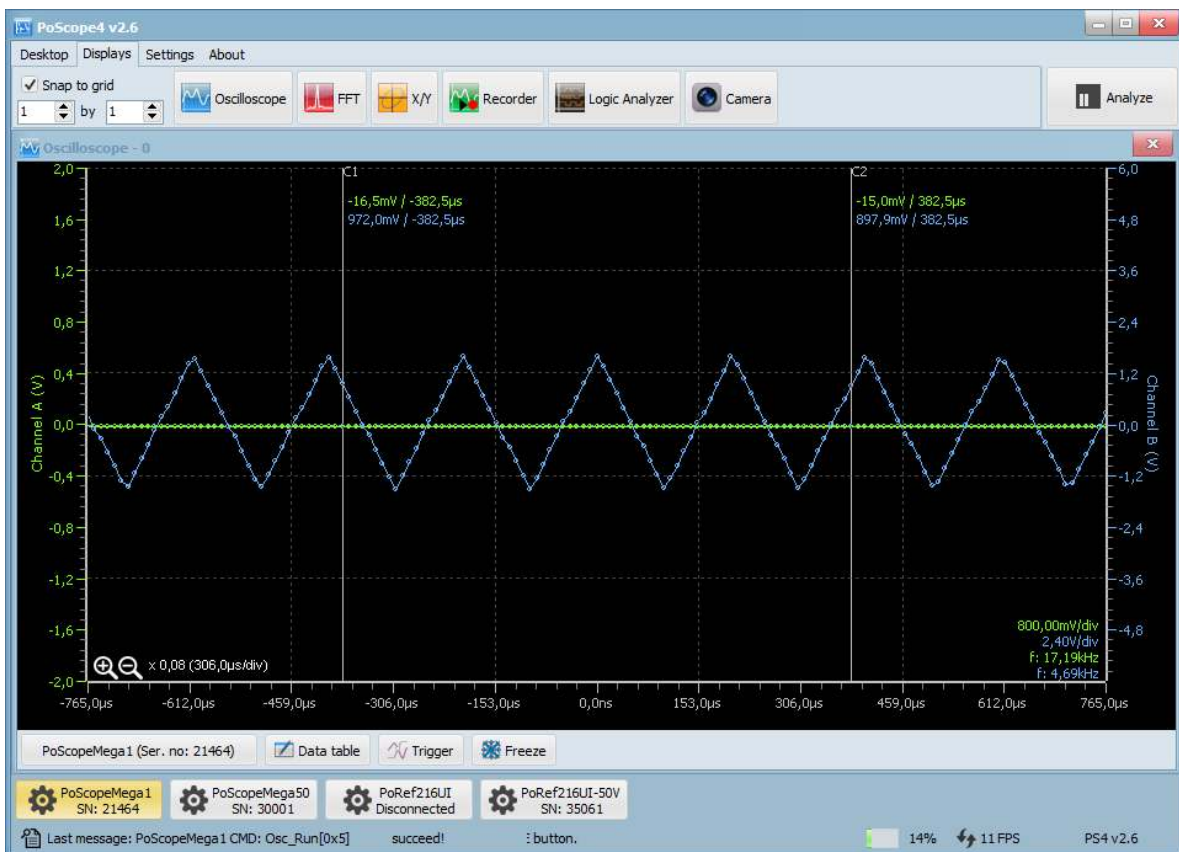

Function generator triangle waveform

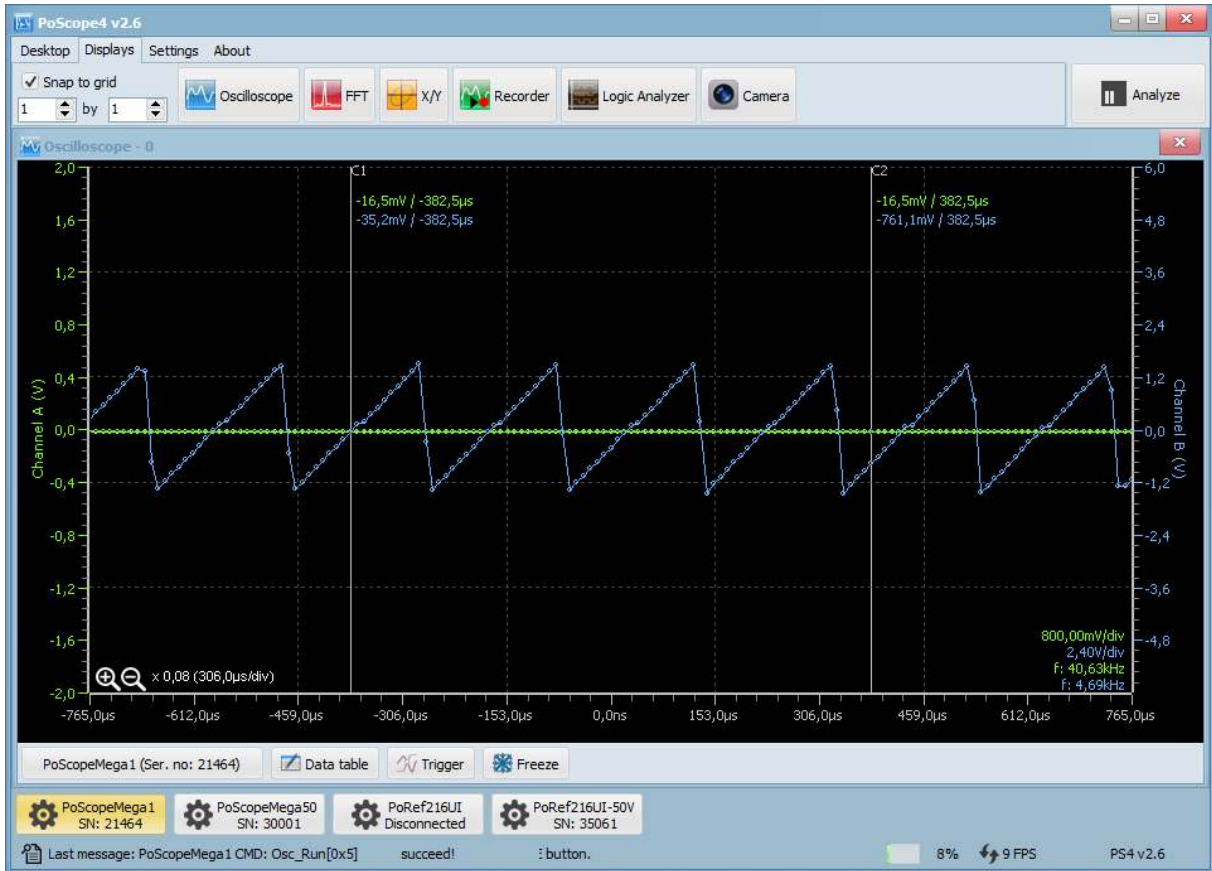

Function generator saw waveform

TECHNICAL SPECIFICATIONS FOR MEGA1(+)

Oscilloscope	
No. of channels	2 channels
Sample rate	1.0 MS/s (dual channel) 2.5 MS/s (single channel)
Input voltage	-20 V ... +20 V WARNING: Do not connect the oscilloscope to voltages higher than specified.
ADC resolution	12 bits
Triggering	Rising, falling, any
Spectrum analyzer	
No. of channels	2 channels
Sample rate	1.0 MS/s (dual channel) 2.5 MS/s (single channel)
Input voltage	-20 V ... +20 V
ADC resolution	12 bits
Window functions	Hamming Hanning Blackman Blackman-Harris, etc.
Recorder	
No. of channels	2 channels
Sample rate	200kS/s (dual channel) 12-bit mode 500kS/s (single channel) 12-bit mode 500kS/s (dual channel) 8 bit mode 1MS/s (single channel) 8 bit mode
Input voltage	-20 V ... +20 V
ADC resolution	12 bits
Triggering	Rising, falling, any
Advanced functions	Waveform record, Direct recording to PCM
Logic analyzer	
No. of channels	16 channels
Input voltage	0 ... 5.0 V
Triggering	Edge, level, mask (coming soon)
Decoding	I2C, I2C sensors, UART, SPI (1-WIRE coming soon)
Function generator	
No. of channels	1 channel
Waveforms	Sine, square, saw, triangle
Max. signal frequency	12,5 kHz
Physical characteristics	
Dimensions (w x d x h)	92mm x 74 x 23mm (incl. connectors)
Weight	76 grams
Connections	3x coaxial BNC connector 1x standard D-sub 25, female 1x standard USB type B, female
Current consumption	ONLY 60 mA

TECHNICAL SPECIFICATIONS FOR MEGA50

Oscilloscope	
No. of channels	2 channels
Sample rate	48MHz
Bandwidth	15MHz
Input voltage	-30 V ... +30 V WARNING: Do not connect the oscilloscope to voltages higher than specified.
ADC resolution	8 bits
Triggering	Rising, falling, any
Spectrum analyzer	
No. of channels	2 channels
Sample rate	48MHz
Input voltage	-30 V ... +30 V
ADC resolution	8 bits
Window functions	Hamming, Hanning, Blackman, Blackman-Harris, etc.
Recorder	
No. of channels	2 channels
Sample rate	15MHz
Input voltage	-30 V ... +30 V
ADC resolution	8 bits
Triggering	Rising, falling, any
Advanced functions	Waveform record, Direct recording to PCM
Logic analyzer	
No. of channels	16 channels
Sample rate	48MHz
Bandwidth	5MHz
Input voltage	0 ... 5.0 V
Triggering	Edge, level, mask (coming soon)
Decoding	I2C, I2C sensors, UART, SPI (1-WIRE coming soon)
Function generator	
No. of channels	1 channel
Waveforms	Sine, square, saw, triangle
Max. signal frequency	12,5 kHz
Physical characteristics	
Dimensions (w x d x h)	92mm x 74 x 23mm (incl. connectors)
Weight	76 grams
Connections	3x coaxial BNC connector 1x standard D-sub 25, female 1x standard USB type B, female
Current consumption	Only 150mA

LEGAL NOTES

1. All information included in this document is current as of the date this document is issued. Such information, however, is subject to change without any prior notice.
2. PoLabs does not assume any liability for infringement of patents, copyrights, or other intellectual property rights of third parties by or arising from the use of PoLabs products or technical information described in this document. No license, express, implied or otherwise, is granted hereby under any patents, copyrights or other intellectual property rights of PoLabs or others. PoLabs claims the copyright of, and retains the rights to, all material (software, documents, etc.) contained in this release. You may copy and distribute the entire release in its original state, but must not copy individual items within the release other than for backup purposes.
3. Descriptions of circuits, software and other related information in this document are provided only to illustrate the operation of the products and application examples. You are fully responsible for the incorporation of these circuits, software, and information in the design of your equipment. PoLabs assumes no responsibility for any losses incurred by you or third parties arising from the use of these circuits, software, or information.
4. PoLabs has used reasonable care in preparing the information included in this document, but PoLabs does not warrant that such information is error free. PoLabs assumes no liability whatsoever for any damages incurred by you resulting from errors in or omissions from the information included herein.
5. PoLabs devices may be used in equipment that does not impose a threat to human life in case of the malfunctioning, such as: computer interfaces, office equipment, communications equipment, test and measurement equipment, audio and visual equipment, home electronic appliances, machine tools, personal electronic equipment, and industrial robots.
6. Measures such as fail-safe function and redundant design should be taken to ensure reliability and safety when PoLabs devices are used for or in connection with equipment that requires higher reliability, for example: traffic control systems, anti-disaster systems, anticrime systems, safety equipment, medical equipment not specifically designed for life support, and other similar applications.
7. PoLabs devices shall not be used for or in connection with equipment that requires an extremely high level of reliability and safety, as for example: aircraft systems, aerospace equipment, nuclear reactor control systems, medical equipment or systems for life support (e.g. artificial life support devices or systems), and any other applications or purposes that pose a direct threat to human life.
8. You should use the PoLabs products described in this document within the range specified by PoLabs, especially with respect to the maximum rating, operating supply voltage range and other product characteristics. PoLabs shall have no liability for malfunctions or damages arising out of the use of PoLabs products beyond such specified ranges.
9. Although PoLabs endeavors to improve the quality and reliability of its products, semiconductor products have specific characteristics such as the occurrence of failure at a certain rate and malfunctions under certain use conditions. Further, PoLabs products are not subject to radiation resistance design. Please be sure to implement safety measures to guard them against the possibility of physical injury, and injury or damage caused by fire in the event of the failure of a PoLabs product, such as safety design for hardware and software including

- but not limited to redundancy, fire control and malfunction prevention, appropriate treatment for aging degradation or any other appropriate measures.
10. Usage: the software in this release is for use only with PoLabs products or with data collected using PoLabs products.
 11. Fitness for purpose: no two applications are the same, so PoLabs cannot guarantee that its equipment or software is suitable for a given application. It is therefore the user's responsibility to ensure that the product is suitable for the user's application.
 12. Viruses: this software was continuously monitored for viruses during production, however the user is responsible for virus checking the software once it is installed.
 13. Upgrades: we provide upgrades, free of charge, from our web site at www.poscope.com. We reserve the right to charge for updates or replacements sent out on physical media.
 14. Please contact a PoLabs support for details as to environmental matters such as the environmental compatibility of each PoLabs product. Please use PoLabs products in compliance with all applicable laws and regulations that regulate the inclusion or use of controlled substances, including without limitation, the EU RoHS Directive. PoLabs assumes no liability for damages or losses occurring as a result of your noncompliance with applicable laws and regulations.
 15. Please contact a PoLabs support at support@poscope.com if you have any questions regarding the information contained in this document or PoLabs products, or if you have any other inquiries.
 16. The licensee agrees to allow access to this software only to persons who have been informed of and agree to abide by these conditions.
 17. Trademarks: Windows is a registered trademark of Microsoft Corporation. PoKeys, PoKeys55, PoKeys56U, PoKeys56E, PoScope3, PoScope4, Basic, Basic2, Mega1, Mega50, PoRef216U, PoDDS, PoScope, PoLabs and others are internationally registered trademarks.

GRANT OF LICENSE

The material contained in this release is licensed, not sold. PoLabs grants a license to the person who installs this software, subject to the conditions listed below.

Access

The licensee agrees to allow access to this software only to persons who have been informed of and agree to abide by these conditions.

Usage

The software in this release is for use only with PoLabs products or with data collected using PoLabs products.

Copyright

PoLabs claims the copyright of, and retains the rights to, all material (software, documents etc) contained in this release. You may copy and distribute the entire release in its original state, but must not copy individual items within the release other than for backup purposes.

Liability

PoLabs and its agents shall not be liable for any loss or damage, howsoever caused, related to the use of PoLabs equipment or software, unless excluded by statute.

Fitness for purpose

No two applications are the same, so PoLabs cannot guarantee that its equipment or software is suitable for a given application. It is therefore the user's responsibility to ensure that the product is suitable for the user's application.

Mission Critical applications

Because the software runs on a computer that may be running other software products, and may be subject to interference from these other products, this license specifically excludes usage in 'mission critical' applications, for example life support systems.

Viruses

This software was continuously monitored for viruses during production, however the user is responsible for virus checking the software once it is installed.

Support

No software is ever error-free, but if you are unsatisfied with the performance of this software, please contact our technical support staff, who will try to fix the problem within a reasonable time.

Upgrades

We provide upgrades, free of charge, from our web site at www.poscope.com. We reserve the right to charge for updates or replacements sent out on physical media.

Trademarks

Windows is a registered trademark of Microsoft Corporation. PoKeys, PoKeys55, PoKeys56U, PoKeys56E, PoScope, PoScope3, PoScope4, Basic, Basic2, Mega1, Mega50, PoRef216U, PoDDS, PoLabs and others are internationally registered trademarks. PoLabs uses Facebook, YouTube and

Twitter as channels to inform users of PoLabs products. As such PoLabs doesn't have any strings attached to those companies or their trademarks.