

### ■ Features

- High Luminous LEDs
- 5mm Round Standard Directivity
- Superior Weather-resistance
- UV Resistant Epoxy
- Integral Current Limiting Resistor
- TTL Compatible (Requires No External Current Limiter With 12 Volt Supply)
- Cost Effective (Saves Space and Resistor Cost)
- Water clear Type

### ■ Applications

- Status Indicators
- Other Lighting

### ■ Outline Dimension

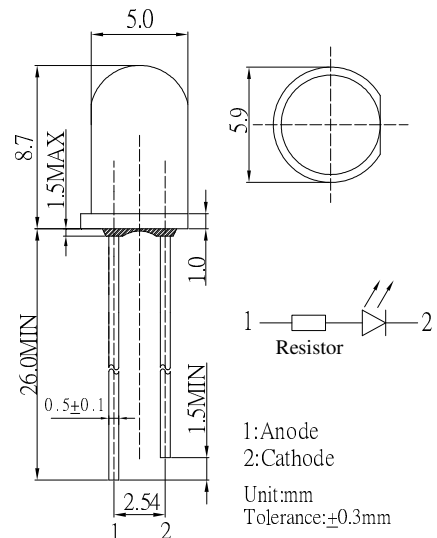

### ■ Absolute Maximum Rating

(Ta=25°C)





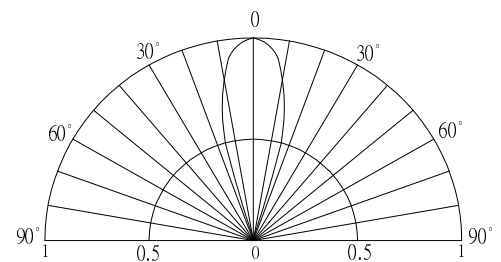

Item	Symbol	Value	Unit
DC Forward Voltage	V <sub>F</sub>	7.5	V
Reverse Voltage	V <sub>R</sub>	5	V
Power Dissipation	P <sub>D</sub>	150	mW
Operating Temperature	Topr	-30 ~ +85	°C
Storage Temperature	Tstg	-40~ +100	°C
Lead Soldering Temperature	Tsol	260°C/5sec	-

### ■ Directivity



### ■ Electrical -Optical Characteristics

(Ta=25°C)

Part Number	Color			I <sub>F</sub> (mA)			I <sub>v</sub> (mcd)*			λD(nm)*			2θ1/2(deg)
				Min	Typ.	Max.	Min.	Typ.	Max.	Min.	Typ.	Max.	Typ.
				V <sub>F</sub> =5V			V <sub>F</sub> =5V						
OSW5DK5A31A-5V	White	W		-	12	20	3000	4200	-	X=0.27, Y=0.28			30
OSM5DK5A31A-5V	Warm White	M		-	12	20	2180	3000	-	X=0.45, Y=0.41			30
OSK5DK5A31A-5V	Pink	K		-	12	20	1120	1560	-	X=0.45, Y=0.17			30
OSB5SA5A31A-5V	Blue	B		-	12	20	1560	2180	-	465	470	475	30
OSG5DA5A31A-5V	Pure Green	TG		-	12	20	3000	4200	-	520	525	530	30
OSG8HA5A31A-5V	Yellow Green	G		-	12	20	500	750	-	565	570	575	30
OSY5RU5A31A-5V	Yellow	Y		-	12	20	1120	1560	-	585	590	595	30
OSO5JA5A31A-5V	Orange	O		-	12	20	1120	1560	-	600	605	610	30
OSR5RU5A31A-5V	Red	R		-	12	20	1120	1560	-	620	625	630	30

\*1 Tolerance of chromaticity coordinates is ±10%

\*2 Tolerance of luminous intensity is ±15%