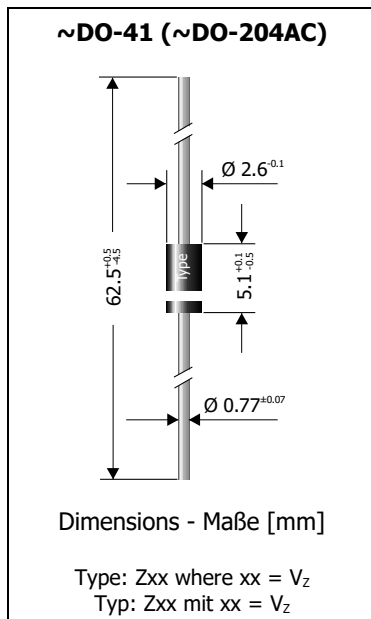

ZY1 ... ZY200
Zener Diodes (non-planar technology)
Flächendiffundierte Zener-Dioden
P_{tot} = 2 W
V_Z = 1 V ... 200 V
T_{jmax} = 150°C

Version 2016-11-23

**Typical Applications**

Voltage stabilization and regulators
(For overvoltage protection
– uni- and bi-directional – see
TVS diodes BZW04/P4KE series)
Commercial grade ¹⁾)

Features

High power dissipation
V_Z up to 200 V
Compliant to RoHS, REACH,
Conflict Minerals ¹⁾)

**Mechanical Data ¹⁾**

Taped in ammo pack 5000
Weight approx. 0.4 g
Case material UL 94V-0
Solder & assembly conditions 260°C/10s
MSL N/A

Typische Anwendungen

Spannungsstabilisierung und -regler
(Für Überspannungsschutz
– uni- und bidirektional – siehe
TVS-Diodenreihe BZW04/P4KE)
Standardausführung ¹⁾)

Besonderheiten

Hohe Leistungsfähigkeit
V_Z bis zu 200 V
Konform zu RoHS, REACH,
Konfliktmineralien ¹⁾)

Mechanische Daten ¹⁾

Gegurtet in Ammo-Pack
Gewicht ca.
Gehäusematerial
Löt- und Einbaubedingungen

Standard Zener voltage tolerance is graded to the international E 24 (~ ±5%) standard.
Other voltage tolerances and higher Zener voltages on request.

Die Toleranz der Zener-Spannung ist in der Standard-Ausführung gestuft nach der internationalen Reihe E 24 (~ ±5%). Andere Toleranzen oder höhere Arbeitsspannungen auf Anfrage.

Maximum ratings ²⁾**Grenzwerte ²⁾**

Power dissipation – Verlustleistung	T _A = 50°C	P _{tot}	2 W ³⁾
Non repetitive peak power dissipation, t < 1 ms Einmalige Impuls-Verlustleistung, t < 1 ms		P _{ZSM}	60 W ³⁾
Operating junction temperature – Sperrschichttemperatur Storage temperature – Lagerungstemperatur		T _j T _S	--50...+150°C -50...+175°C

Characteristics**Kennwerte**

Thermal resistance junction to ambient Wärmewiderstand Sperrschicht – Umgebung	R _{thA}	<45 K/W ³⁾
Thermal resistance junction to lead Wärmewiderstand Sperrschicht – Anschlussdraht	R _{thL}	<15 K/W

- 1 Please note the [detailed information on our website](#) or at the beginning of the data book
Bitte beachten Sie die [detaillierten Hinweise auf unserer Internetseite](#) bzw. am Anfang des Datenbuches
- 2 T_A = 25°C unless otherwise specified – T_A = 25°C wenn nicht anders angegeben
- 3 Valid, if leads are kept at ambient temperature at a distance of 10 mm from case
Gültig, wenn die Anschlussdrähte in 10 mm Abstand vom Gehäuse auf Umgebungstemperatur gehalten werden
- 4 Tested with pulses – Gemessen mit Impulsen
- 5 The ZPY1 is a diode operated in forward. Hence, the index of all parameters should be "F" instead of "Z".
The cathode, indicated by a white band, has to be connected to the negative pole.
Die ZPY1 ist eine in Durchlass betriebene Si-Diode. Daher ist bei allen Kenn- und Grenzwerten der Index "F" anstatt "Z" zu setzen. Die mit weißem Balken gekennzeichnete Kathode ist mit dem Minuspol zu verbinden.

Characteristics

 (T_j = 25°C unless otherwise specified)

Kennwerte

 (T_j = 25°C wenn nicht anders spezifiziert)

Type Typ	Zener voltage ⁴⁾ Zener-Spannung ⁴⁾ I _Z = I _{Ztest}		Test current Mess-Strom I _{Ztest} [mA]	Dynamic resistance Diff. Widerstand I _{Ztest} / f = 1 kHz r _{zj} [Ω]	Temp. Coeff. of Z-voltage ...der Z-Spannung α _{VZ} [10 ⁻⁴ /°C]	Reverse volt. Sperrspanng. I _R = 1 μA V _R [V]	Z-current ³⁾ Z-Strom ³⁾ T _A = 50°C I _{Zmax} [mA]
	V _{zmin} [V]	V _{zmax} [V]					
ZY1 ⁵⁾	0.71	0.82	100	0.5 (<1)	-26...-16	-	1500
ZY5.6	5.2	6.0	100	1 (<3)	-3...+5	> 0.5 / 3 μA	333
ZY6.2	5.8	6.6	100	1 (<2)	-1...+6	> 1.5	303
ZY6.8	6.4	7.2	100	1 (<2)	0...+7	> 2	278
ZY7.5	7.0	7.9	100	1 (<2)	0...+7	> 2	253
ZY8.2	7.7	8.7	100	1 (<2)	+3...+8	> 3.5	230
ZY9.1	8.5	9.6	50	2 (<4)	+3...+8	> 3.5	208
ZY10	9.4	10.6	50	2 (<4)	+5...+9	> 5	189
ZY11	10.4	11.6	50	4 (<7)	+5...+10	> 5	172
ZY12	11.4	12.7	50	4 (<7)	+5...+10	> 7	157
ZY13	12.4	14.1	50	5 (<10)	+5...+10	> 7	142
ZY15	13.8	15.6	50	5 (<10)	+5...+10	> 10	128
ZY16	15.3	17.1	25	6 (<15)	+6...+11	> 10	117
ZY18	16.8	19.1	25	6 (<15)	+6...+11	> 10	105
ZY20	18.8	21.2	25	6 (<15)	+6...+11	> 10	94
ZY22	20.8	23.3	25	6 (<15)	+6...+11	> 12	86
ZY24	22.8	25.6	25	7 (<15)	+6...+11	> 12	78
ZY27	25.1	28.9	25	7 (<15)	+6...+11	> 14	69
ZY30	28	32	25	8 (<15)	+6...+11	> 14	63
ZY33	31	35	25	8 (<15)	+6...+11	> 17	57
ZY36	34	38	10	16 (<40)	+6...+11	> 17	53
ZY39	37	41	10	20 (<40)	+6...+11	> 20	49
ZY43	40	46	10	24 (<45)	+7...+12	> 20	43
ZY47	44	50	10	24 (<45)	+7...+12	> 24	40
ZY51	48	54	10	25 (<60)	+7...+12	> 24	37
ZY56	52	60	10	25 (<60)	+7...+12	> 28	33
ZY62	58	66	10	25 (<80)	+8...+13	> 28	30
ZY68	64	72	10	25 (<80)	+8...+13	> 34	28
ZY75	70	79	10	30 (<100)	+8...+13	> 34	25
ZY82	77	88	10	30 (<100)	+8...+13	> 41	23
ZY91	85	96	5	40 (<200)	+9...+13	> 41	21
ZY100	94	106	5	60 (<200)	+9...+13	> 50	19
ZY110	104	116	5	80 (<250)	+9...+13	> 50	17
ZY120	114	127	5	80 (<250)	+9...+13	> 60	16
ZY130	124	141	5	90 (<300)	+9...+13	> 60	14
ZY150	138	156	5	100 (<300)	+9...+13	> 75	13
ZY160	153	171	5	110 (<350)	+9...+13	> 75	12
ZY180	168	191	5	120 (<350)	+9...+13	> 90	10
ZY200	188	212	5	150 (<350)	+9...+13	> 90	9

3,4,5 Notes see previous page – Fußnoten siehe vorhergehende Seite

ZY1 ... ZY200

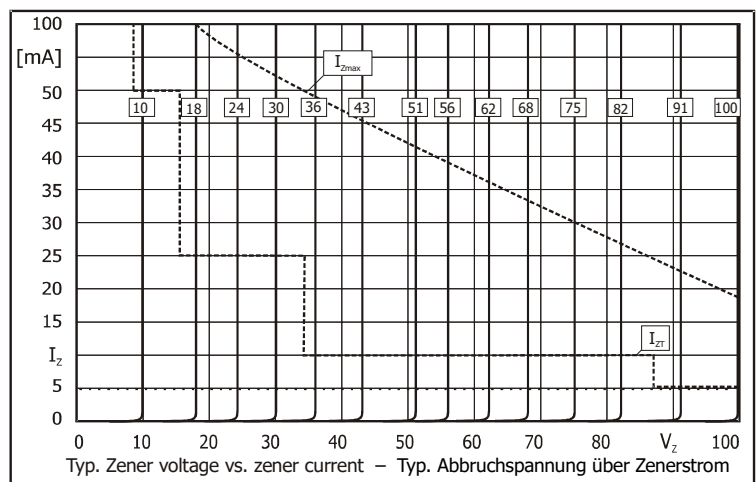
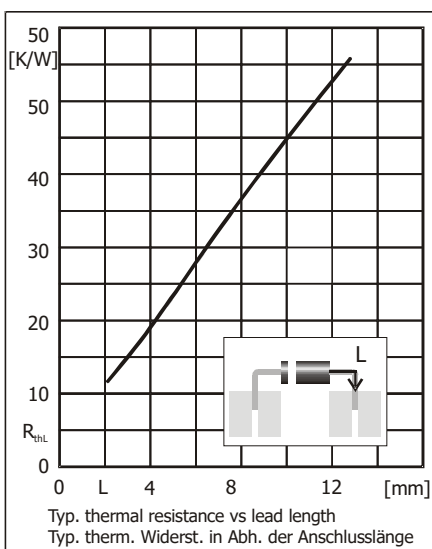
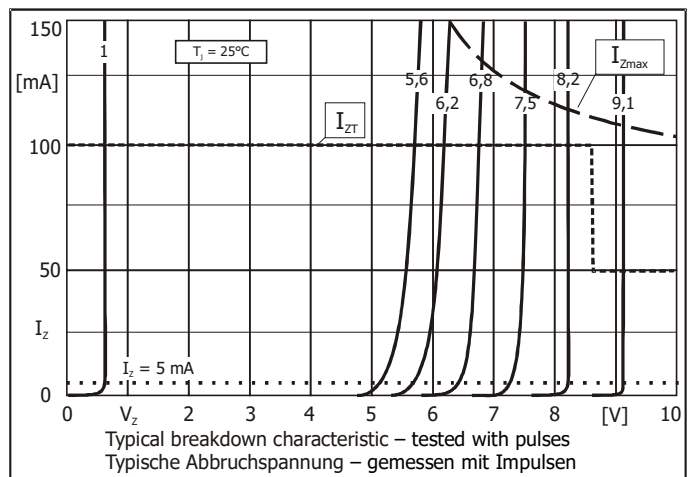
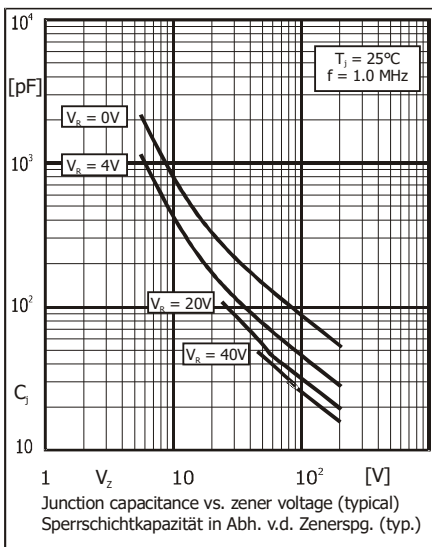
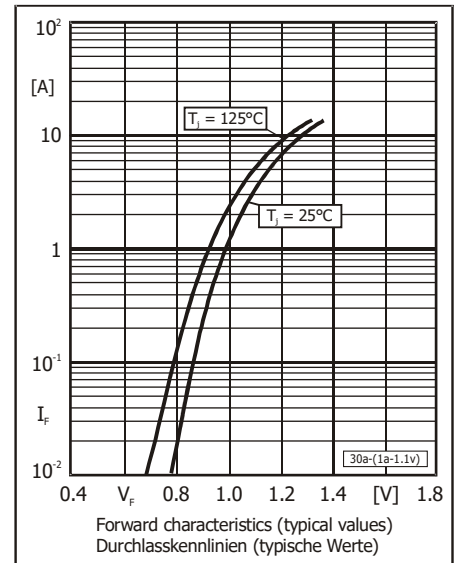
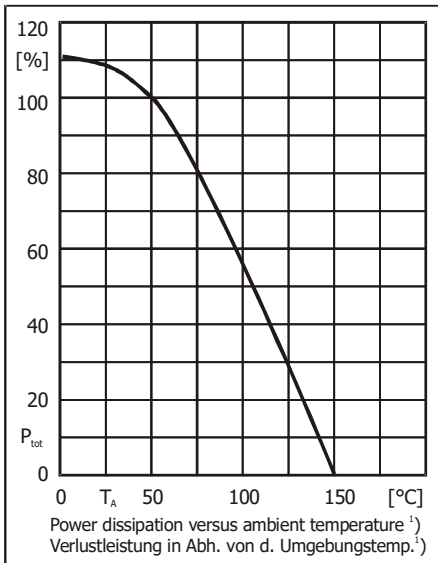

Disclaimer: See data book page 2 or [website](#)
Haftungsausschluss: Siehe Datenbuch Seite 2 oder [Internet](#)