

START

1

Resistor - Weerstand - Résistance - Widerstand - Resistencia - Motstand - Vastus - Resistenze

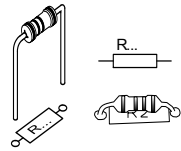

◇ R1 : 10K	(Brown, Black, Orange) - (Bruin, Zwart, Oranje) - (Brun, noir, Orange) - (Braun, Schwarz, Orange) - (Brun, Svart, Orange) - (Ruskea, Musta, Oranssi) - (Marrón, Negro, Naranjado) - (Castanho, Preto, Laranja) - (Marrone, Nero, Aranciato)
◇ R2 : 330K	(Orange, Orange, Yellow) - (Oranje, Oranje, Geel) - (Orange, Orange, Jaune) - (Orange, Orange, Gelb) - (Orange, Orange, Gul) - (Oranssi, Oranssi, Keltainen) - (Naranjado, Naranjado, Amarillo) - (Laranja, Laranja, Amarelo) - (Aranciato, Aranciato, Giallo)
◇ R3 ... R5: 100K	(Brown, Black, Yellow) - (Bruin, zwart, Geel) - (Brun, noir, Jaune) - (Braun, Schwarz, Gelb) - (Brun, Svart, Gul) - (Ruskea, Musta, Keltainen) - (Marrón, Negro, Amarillo) - (Castanho, Preto, Amarelo) - (Marrone, Nero, Giallo)
◇ R6 ... R9: 47E	(Yellow, Purple, Black) - (Geel, Paars, Zwart) - (Jaune, Violet, Noir) - (Gelb, Violet, Schwarz) - (Gul, Lila, Svart) - (Keltainen, Purppura, Musta) - (Amarillo, Morado, Negro) - (Amarelo, Violeta, Preto) - (Giallo, Viola, Nero)
◇ R10 ... R12 : 1M5	(Brown, Green, Green) - (Bruin, Groen, Groen) - (Brun, Vert, Vert) - (Braun, Grün, Grün) - (Brun, Grön, Grön) - (Ruskea, Vihreä, Vihreä) - (Marrón, Verde, Verde) - (Castanho, Verde, Verde) - (Marrone, Verde, Verde)
◇ R13, R14 : 47K	(Yellow, Purple, Orange) - (Geel, Paars, Oranje) - (Jaune, Violet, Orange) - (Gelb, Violet, Orange) - (Gul, Lila, Orange) - (Keltainen, Purppura, Oranssi) - (Amarillo, Morado, Naranjado) - (Amarelo, Violeta, Laranja) - (Giallo, Viola, Aranciato)

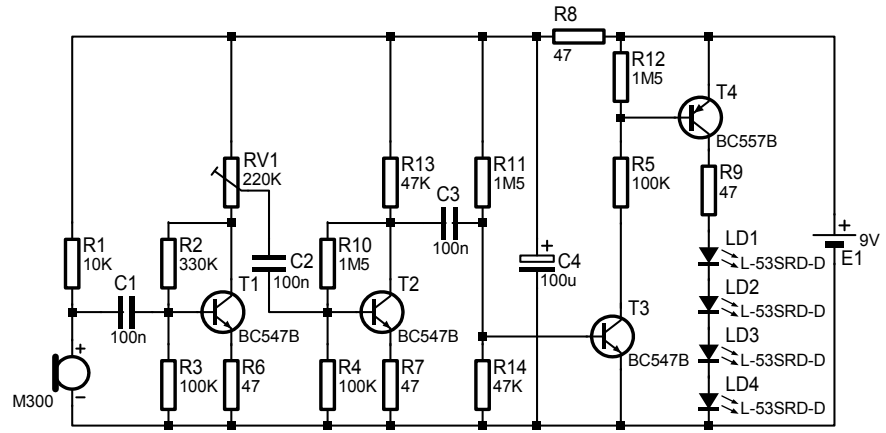

MIK103 \_ rev.1

2 LED

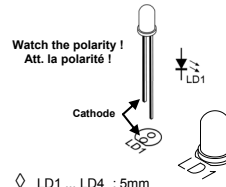

3 Transistor

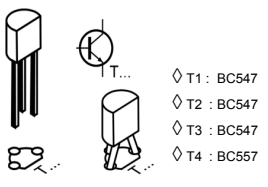

4 Capacitor

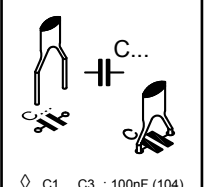

5 Electrolytic capacitor

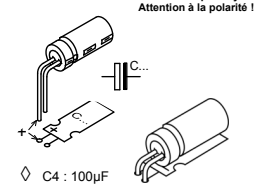

6 Trimmer

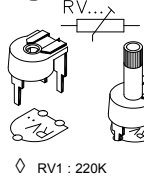

7 Microphone

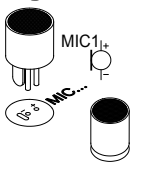

8

