



Features

- Surface mount devices
- High voltage surge capabilities
- Binned and sorted resistance ranges
- Assists in meeting ITU K.20/K.21 specifications
- RoHS compliant*
- Agency recognition:  

Applications

Used as a secondary overcurrent protection device in:

- Customer Premise Equipment (CPE)
- Central Office (CO)
- Subscriber Line Interface Cards (SLIC)

MF-SM/250 - Telecom PTC Resettable Fuses

Electrical Characteristics

Model	Max. Operating Voltage	Max. Interrupt Ratings		Hold Current	Initial Resistance		One Hour Post-Trip Resistance	Tripped Power Dissipation
	Volts (V)	Volts (V)	Amps (A)	Amps at 23 °C	Ohms at 23 °C	Ohms at 23 °C	Ohms at 23 °C	Watts at 23 °C
		Max.	Max.	I _H	Min.	Max.	Max.	Typ.
MF-SM008/250F-2	80	250	3.0	0.08	5.0	11.0	20.0	1.5
MF-SM013/250-2	60	250	3.0	0.13	6.5	12.0	20.0	3.3
MF-SM013/250-A-2	60	250	3.0	0.13	6.5	9.0	20.0	3.3
MF-SM013/250-B-2	60	250	3.0	0.13	9.0	12.0	20.0	3.3
MF-SM013/250-C-2	60	250	3.0	0.13	7.0	10.0	20.0	3.3

Environmental Characteristics

Operating Temperature.....	-40 °C to +85 °C
Maximum Device Surface Temperature	
in Tripped State	125 °C
Passive Aging	+85 °C, 1000 hours..... ±15 % typical resistance change
Humidity Aging.....	+85 °C, 85 % R.H. 1000 hours..... ±15 % typical resistance change
Thermal Shock	MIL-STD-202F, Method 107G..... ±15 % typical resistance change
.....	+125 °C to -55 °C, 10 times..... ±15 % typical resistance change
Solvent Resistance.....	MIL-STD-202, Method 215B..... No change
Lead Solderability	ANSI/J-STD-002
Vibration	MIL-STD-883C, Method 2007.1, Condition A..... No change
Moisture Sensitivity Level (MSL)	Level 1
ESD Classification - HBM.....	Class 6

Test Procedures And Requirements For Model MF-SM/250 Series

Test	Test Conditions	Accept/Reject Criteria
Visual/Mech.....	Verify dimensions and materials.....	Per MF physical description
Resistance.....	In still air @ 23 °C.....	R _{min} ≤ R ≤ R _{max}
Time to Trip.....	At specified current, V _{max} , 23 °C.....	T ≤ max. time to trip (seconds)
Hold Current.....	30 min. at I _{hold}	No trip
Trip Cycle Life.....	V _{max} , I _{max} , 100 cycles.....	No arcing or burning
Trip Endurance.....	V _{max} , 48 hours.....	No arcing or burning
Solderability.....	MIL-STD-202F, Method 208F.....	95 % min. coverage
UL File Number	E174545	
TÜV File Number		
MF-SM008/250-2.....	R50118917	
MF-SM013/250-2.....	R2057213	

Thermal Derating Chart - I_{hold}/ I_{trip} (Amps)

Model	Ambient Operating Temperature								
	-40 °C	-20 °C	0 °C	23 °C	40 °C	50 °C	60 °C	70 °C	85 °C
MF-SM008/250-2	0.124 / 0.34	0.110 / 0.30	0.095 / 0.26	0.080 / 0.22	0.066 / 0.18	0.059 / 0.16	0.051 / 0.14	0.044 / 0.12	0.033 / 0.09
MF-SM013/250-2	0.21 / 0.42	0.18 / 0.37	0.16 / 0.31	0.13 / 0.26	0.10 / 0.23	0.09 / 0.18	0.08 / 0.15	0.07 / 0.12	0.05 / 0.10
MF-SM013/250-A-2	0.21 / 0.42	0.18 / 0.37	0.16 / 0.31	0.13 / 0.26	0.10 / 0.23	0.09 / 0.18	0.08 / 0.15	0.07 / 0.12	0.05 / 0.10
MF-SM013/250-B-2	0.21 / 0.42	0.18 / 0.37	0.16 / 0.31	0.13 / 0.26	0.10 / 0.23	0.09 / 0.18	0.08 / 0.15	0.07 / 0.12	0.05 / 0.10
MF-SM013/250-C-2	0.21 / 0.42	0.18 / 0.37	0.16 / 0.31	0.13 / 0.26	0.10 / 0.23	0.09 / 0.18	0.08 / 0.15	0.07 / 0.12	0.05 / 0.10

*RoHS Directive 2002/95/EC Jan. 27, 2003 including annex and RoHS Recast 2011/65/EU June 8, 2011.

Specifications are subject to change without notice.

The device characteristics and parameters in this data sheet can and do vary in different applications and actual device performance may vary over time.

Users should verify actual device performance in their specific applications.

Additional Features

- Withstands lightning power induction

MF-SM/250 - Telecom PTC Resettable Fuses

BOURNS®

Product Dimensions

Model	A Max.	B Max.	C Max.	D Nom.	E Nom.	G Nom.	H Nom.	I Nom.
MF-SM008/250-2	$\frac{7.9}{(0.311)}$	$\frac{3.7}{(0.146)}$	$\frac{5.3}{(0.209)}$	$\frac{0.3}{(0.012)}$	$\frac{3.8}{(0.149)}$	$\frac{9.7}{(0.383)}$	$\frac{3.1}{(0.122)}$	$\frac{2.3}{(0.091)}$
MF-SM013/250-2	$\frac{9.4}{(0.370)}$	$\frac{3.7}{(0.146)}$	$\frac{7.4}{(0.291)}$	$\frac{0.3}{(0.012)}$	$\frac{3.8}{(0.149)}$	$\frac{9.7}{(0.383)}$	$\frac{4.6}{(0.18)}$	$\frac{1.8}{(0.071)}$
MF-SM013/250-A-2	$\frac{9.4}{(0.370)}$	$\frac{3.7}{(0.146)}$	$\frac{7.4}{(0.291)}$	$\frac{0.3}{(0.012)}$	$\frac{3.8}{(0.149)}$	$\frac{9.7}{(0.383)}$	$\frac{4.6}{(0.18)}$	$\frac{1.8}{(0.071)}$
MF-SM013/250-B-2	$\frac{9.4}{(0.370)}$	$\frac{3.7}{(0.146)}$	$\frac{7.4}{(0.291)}$	$\frac{0.3}{(0.012)}$	$\frac{3.8}{(0.149)}$	$\frac{9.7}{(0.383)}$	$\frac{4.6}{(0.18)}$	$\frac{1.8}{(0.071)}$
MF-SM013/250-C-2	$\frac{9.4}{(0.370)}$	$\frac{3.7}{(0.146)}$	$\frac{7.4}{(0.291)}$	$\frac{0.3}{(0.012)}$	$\frac{3.8}{(0.149)}$	$\frac{9.7}{(0.383)}$	$\frac{4.6}{(0.18)}$	$\frac{1.8}{(0.071)}$

Packaging:
TAPE & REEL: 1500 pcs. per reel

DIMENSIONS: $\frac{\text{MM}}{\text{(INCHES)}}$

Recommended Pad Layout

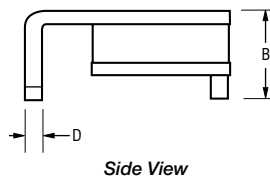
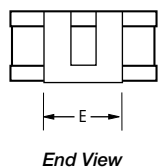
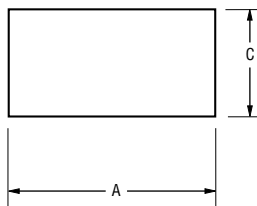

Terminal material:
Tin-plated brass

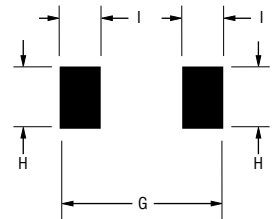

Solder Reflow Recommendations

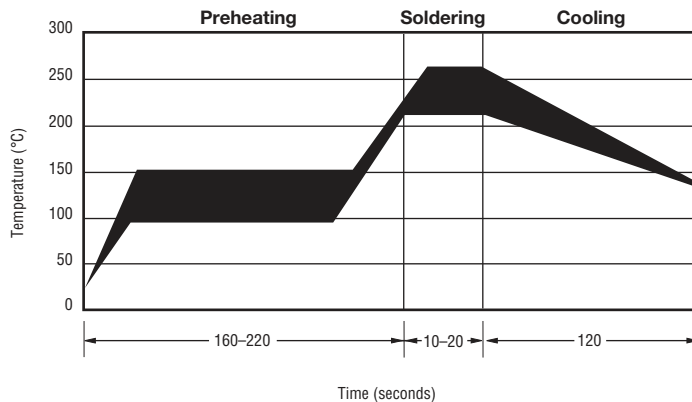

Solder reflow

- Recommended reflow methods: IR, vapor phase oven, hot air oven.
- Devices are not designed to be wave soldered to the bottom side of the board.
- Gluing the devices is not recommended.
- Recommended maximum paste thickness is 0.25 mm (.010 inch).
- Devices can be cleaned using standard industry methods and solvents.

Note:

- If reflow temperatures exceed the recommended profile, devices may not meet the performance requirements.

Rework

- A device should not be reworked.

Storage Recommendations

The recommended long term storage conditions for Multifuse® Polymer PTC devices are 40 °C maximum and 70 % RH maximum. All devices should remain in the original sealed packaging prior to use. Devices may not conform with data sheet specifications if these storage recommendations are exceeded. Devices stored in this manner have an indefinite shelf life.

MF-SM/250 - Telecom PTC Resettable Fuses



Typical Time to Trip at 23 °C

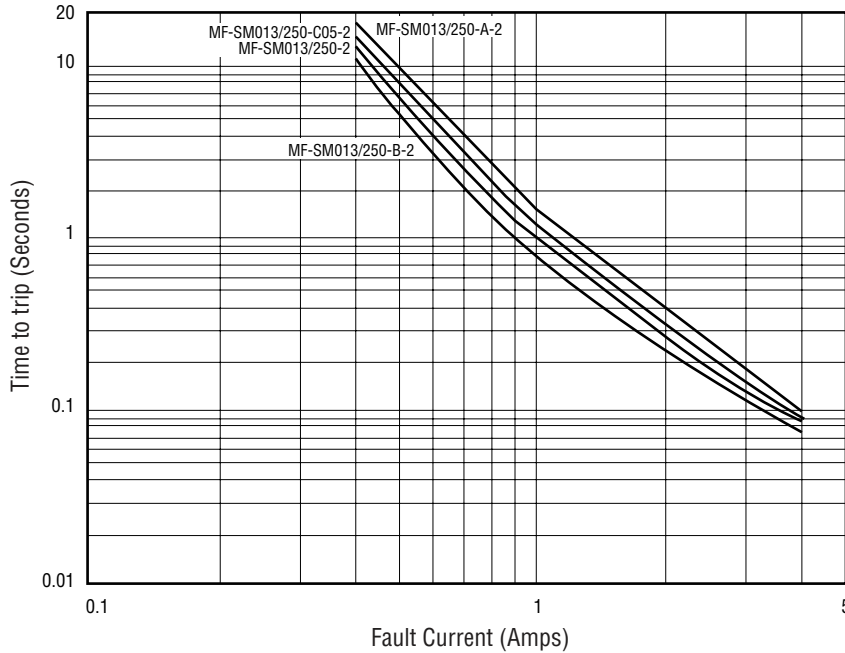

Typical Part Marking

Represents total content. Layout may vary.

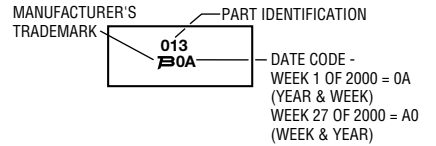

How to Order

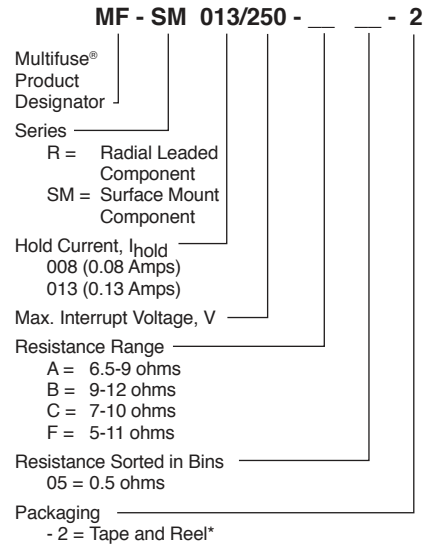

*Packaged per EIA486-B

NOTE: All parts are also available "binned". All parts within a package will be within 0.5 ohms of each other within the initial resistance range.

MF-SM, MF-SM/33, MF-SM/60 & MF-SM/250 Series Tape and Reel Specifications



NOTE: Effective December 1, 2010 (product date code V0), the cover tape was changed to the new 3M™ Universal Cover Tape (UCT).

Tape Dimensions	MF-SM030, 050, 075, 100, 125, 260, 300; MF-SM075/60; MF-SM-100/33; MF-SM008/250 per EIA-481-2	MF-SM150, 200, 250; MF-SM-150/33, MF-SM-185/33; MF-SM013/250 per EIA 481-2
	W max.	16.3 (0.642)
P ₀	4.0 ± 0.1 (0.157 ± 0.004)	4.0 ± 0.1 (0.157 ± 0.004)
P ₁	8.0 ± 0.1 (0.315 ± 0.004)	12.0 ± 0.1 (0.472 ± 0.004)
P ₂	2.0 ± 0.1 (0.079 ± 0.004)	2.0 ± 0.1 (0.079 ± 0.004)
A ₀	5.7 ± 0.1 (0.224 ± 0.004)	6.9 ± 0.1 (0.272 ± 0.004)
B ₀	8.1 ± 0.1 (0.319 ± 0.004)	9.6 ± 0.1 (0.378 ± 0.004)
B ₁ max.	12.1 (0.476)	12.1 (0.476)
D ₀	1.5 + 0.1/-0.0 (0.059 + 0.004/-0)	1.5 + 0.1/-0.0 (0.059 + 0.004/-0)
F	7.5 ± 0.1 (0.295 ± 0.004)	7.5 ± 0.1 (0.295 ± 0.004)
E ₁	1.75 ± 0.1 (0.069 ± 0.004)	1.75 ± 0.1 (0.069 ± 0.004)
E ₂ min.	14.25 (0.561)	14.25 (0.561)
T max.	0.6 (0.024)	0.6 (0.024)
T ₁ max.	0.1 (0.004)	0.1 (0.004)
K ₀	3.4 ± 0.1 (0.134 ± 0.004)	3.4 ± 0.1* (0.134 ± 0.004)*
Leader min.	390 (15.35)	390 (15.35)
Trailer min.	160 (6.30)	160 (6.30)
Reel Dimensions		
A max.	360 (14.17)	360 (14.17)
N min.	50 (1.97)	50 (1.97)
W ₁	16.4 + 2.0/-0.0 (0.646 + 0.079/-0)	16.4 + 2.0/-0.0 (0.646 + 0.079/-0)
W ₂ max.	22.4 (0.882)	22.4 (0.882)

* Model MF-SM013/250 = $\frac{3.8 \pm 0.1}{(0.150 \pm 0.004)}$

DIMENSIONS: MM (INCHES)

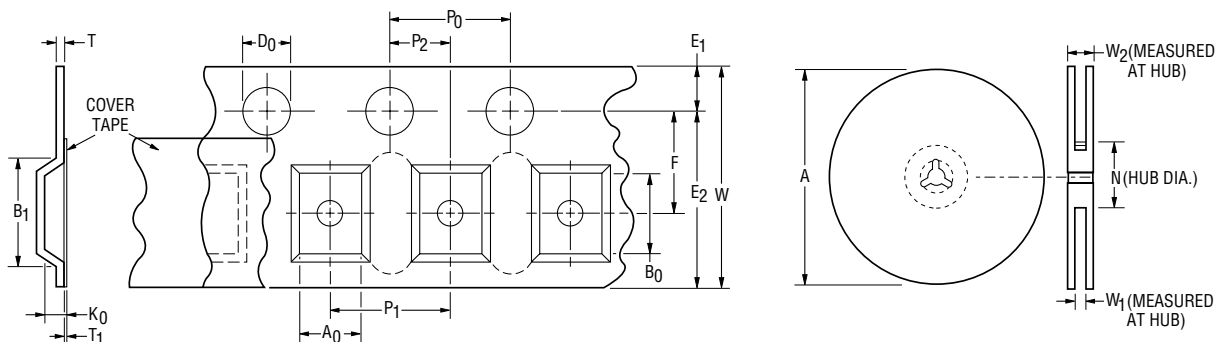

Specifications are subject to change without notice. The device characteristics and parameters in this data sheet can and do vary in different applications and actual device performance may vary over time. Users should verify actual device performance in their specific applications.