

FILE AMEND NOTE	DATE	REV.
ORIGINAL EDITION	2012/10/24	A/0

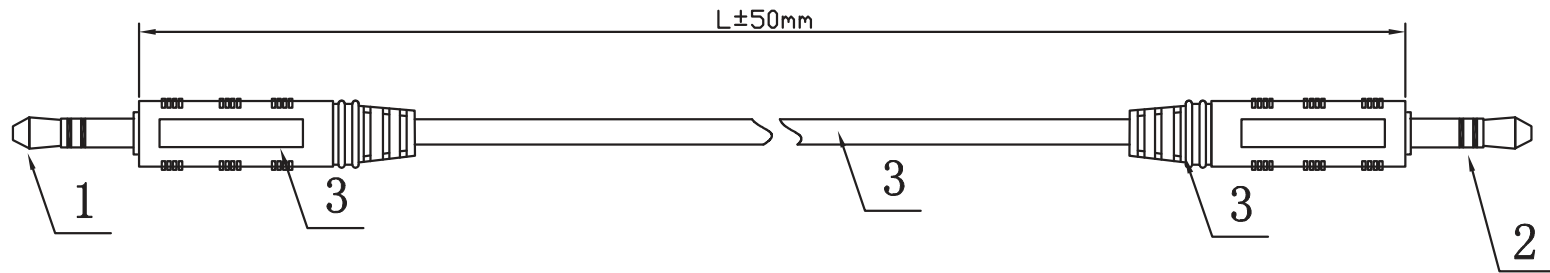

SPECIFICATION

NO.	ITEM NO.	EAN CODE:	L
1	CA1048	4052792008821	0,2m
2	CA1049	4052792008838	1,0m
3	CA1050	4052792008845	2,0m
4	CA1051	4052792008852	3,0m
5	CA1052	4052792008869	5,0m
6	CA1053	4052792008876	10,0m

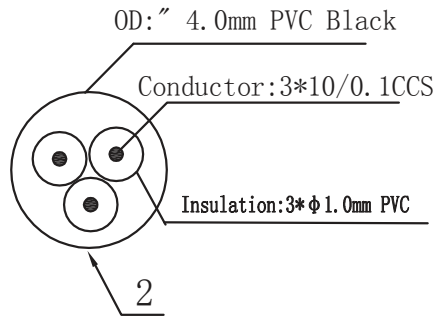

WIRING DIAGRAM

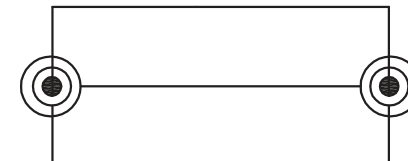

3.5stereo Male black

3.5stereo Male black

NOTE:

Electrical test
100% open short & miss wire test;

MATERIAL LIST

⑦	PRINTING			
⑥	POLY BAG	PE, COLOR: TRANSPARENT	1	
⑤	CABLE	3C AUDIO CABLE Cold Black	L	
④	MOLD HOOD	PVC 45P Cold black	1	
③	MOLD HOOD	PVC 45P Cold black	1	
②	CONNECTOR	3.5STEREO Male NI	1	
①	CONNECTOR	3.5STEREO Male NI	1	
No.	PART NAME	DESCRIPTION	QTY	REMARK

NOTE:

1. TESTING: 100% OPEN AND SHORT AND MISWIRE TEST.
2. INSULATION RESISTANCE: 100Meg Ohm.
3. WITHSTAND VOLTAGE: 500 VOLTS RMS, 1 MINUTE.
4. OPERATING TEMPERATURE RANGE: -20 ! TO + 75 ! .
5. 100% RoHS COMPLIANT.

DRAW No.		NAME	Audio cable, 2X 3,5mm male, stereo,		
CUSTOMER		MAPE	TOLERANCE		
CUSTOMER No.	2direct GmbH		X.	1.00	
APPROVE BY	CHECK BY	DRAW BY	SCALE	MM	
			PAGE	1/2	

FILE AMEND NOTE	DATE	REV.
ORIGINAL EDITION	2012/10/24	A/0

PACKING DRAW



1PCS/BAG

⑥

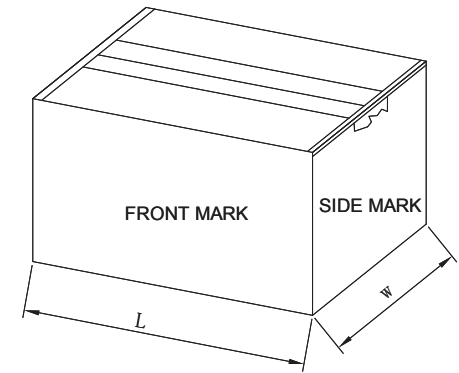
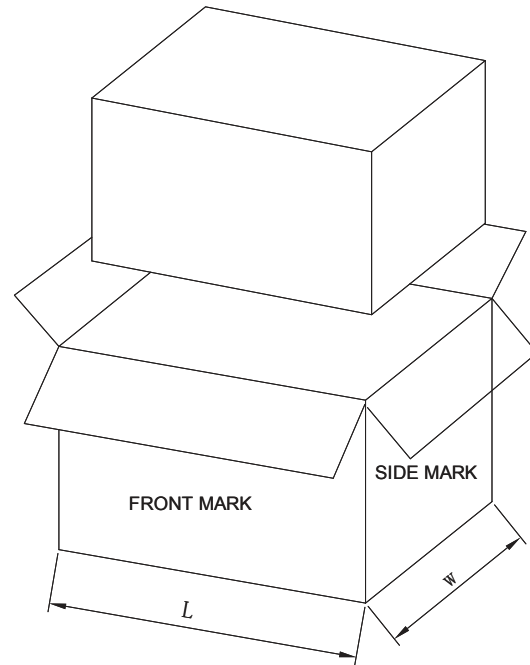
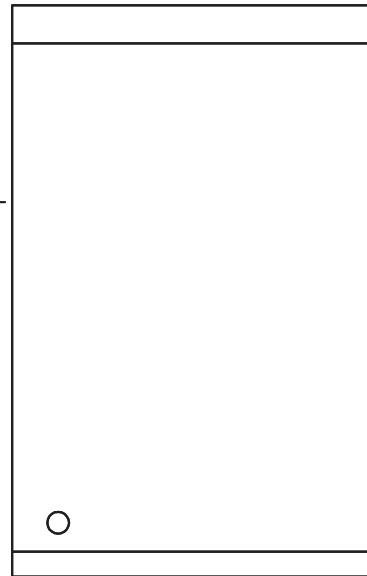

!"# shaped packaging
three packaging tape

STICKER

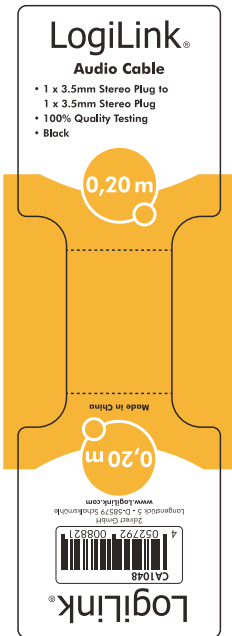

OUTER CARTON
FRONT MARK:

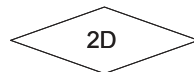

GERMANY
C/NO.:DW 01,02...
MADE IN CHINA

OUTER CARTON
SIDE MARK:

PO NO.:
ITEM NO.:
QTY: PCS
N.W: KGS
G.W: KGS
Dimension:
EAN CODE:

NOTE:

Electrical test
100% open short & miss wire test;

DRAW No.		NAME	Audio cable, 2X 3,5mm male, stereo,		
CUSTOMER		MAPE	TOLERANCE		
CUSTOMER No.	2direct GmbH		X.	1.00	
			X.X	0.50	
APPROVE BY	CHECK BY	DRAW BY	SCALE	MM	
			PAGE	2/2	

No.	PART NAME	DESCRIPTION	QTY	REMARK
-----	-----------	-------------	-----	--------

Pantone 1235C, Black
Size: 48x150 mm R= 2mm
材質: 80P銅版紙, 上亮PP(光膠)