

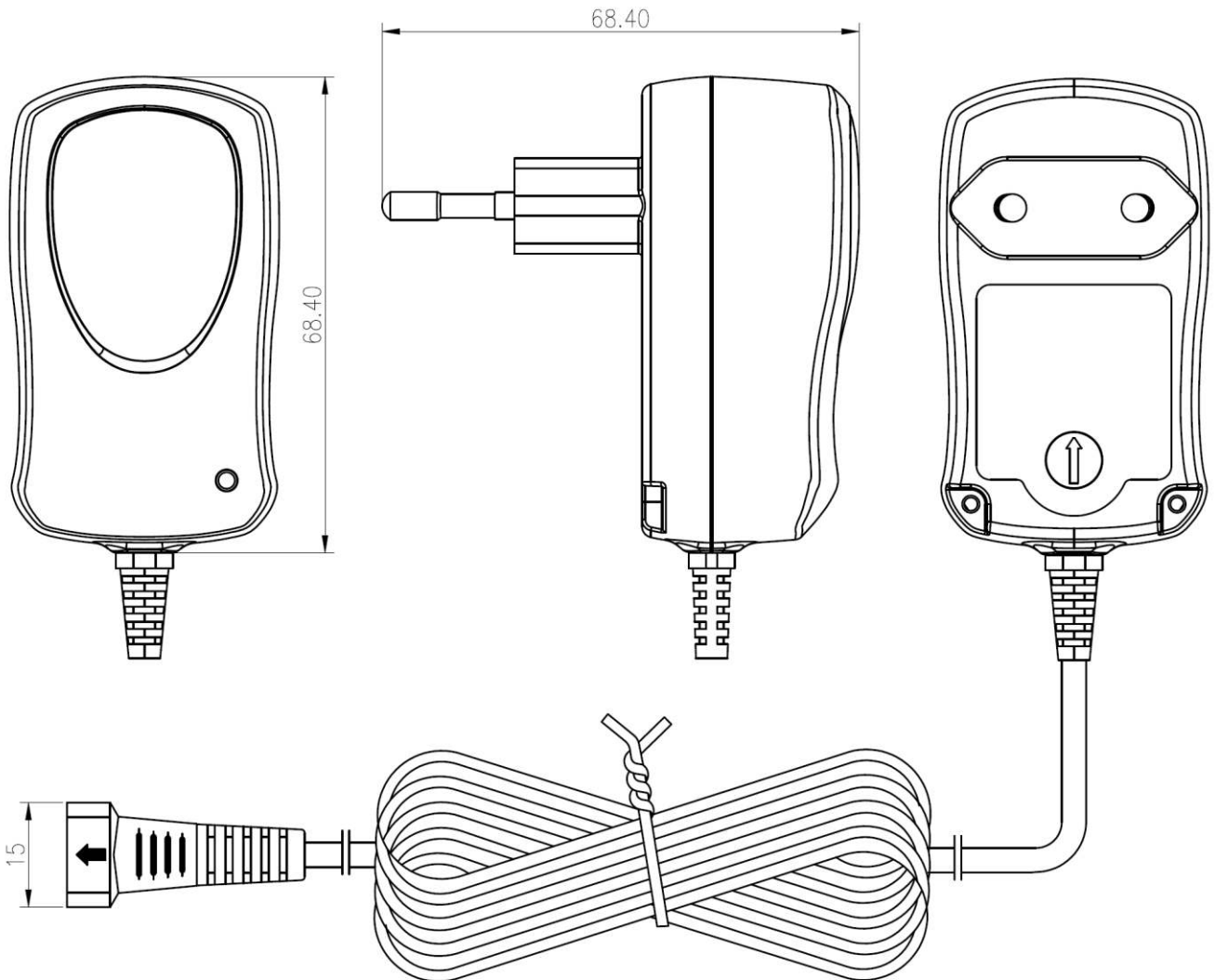

Produktname | *Product name*: HCPS300
 Artikelnummer | *Part Number*: 1201-0005
 Anfragenummer | *Inquiry Number*: AN2019-810401
 Ersteller / Datum | *Creator / Date*: CB / 07.07.2015

Version	Change	Date	Name
V1	Update to ErP Level VI	20.04.20	KA
V0	---	07.07.15	CB



Zuberhör / accessories

Klinkenstecker/
jackplug
ø2,5x13±0.5mm

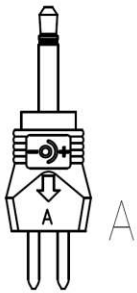

Klinkenstecker/
jackplug
ø3,5x15mm

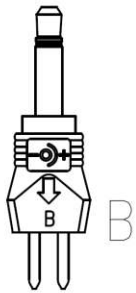

Hohlstecker/
hollowplug
ø2,1xø5x12mm

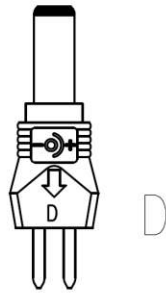

Hohlstecker/
hollowplug
ø2,5xø5,5x12mm

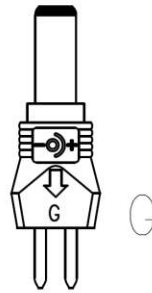

Hohlstecker/
hollowplug
ø1,35xø3,5x10mm

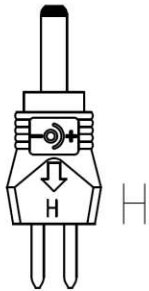

Hohlstecker/
hollowplug
ø1,7xø4x10mm

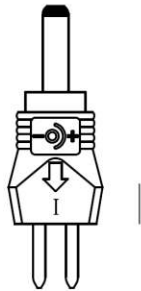

Hohlstecker/
hollowplug
ø2,1xø5,5x12mm

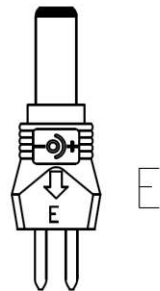

Hohlstecker/
hollowplug
ø1,5xø5,5x12mm

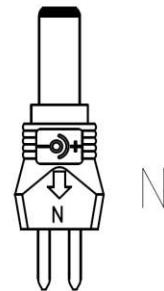

USB Adapterstecker/
USB adapter plug

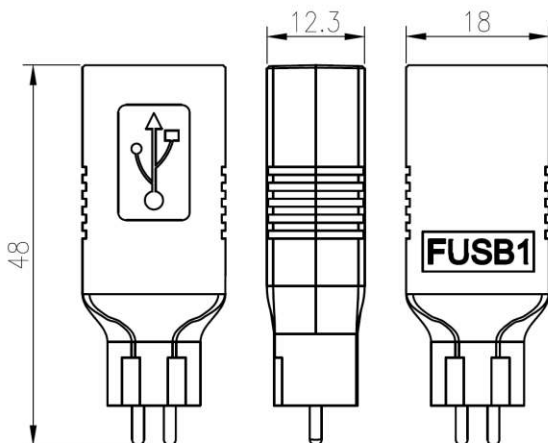

Technische Daten / technical data:



Eingangsspannung:	100-240V ±10% 60/50Hz 155mA	Input voltage:	100-240V ±10% 60/50Hz 155mA
Ausgangsspannung:	3-4.5-5-6-7.5-9-12V ±10% stabilisiert	Output voltage:	3-4.5-5-6-7.5-9-12V ±10% regulated
Ausgangsstrom:	- 3-5V / 600mA ±5% - 6V / 500mA ±5% - 7.5V / 480mA ±5% - 9V / 400mA ±5% - 12V / 300mA ±5%	Output current:	- 3-5V / 600mA ±5% - 6V / 500mA ±5% - 7.5V / 480mA ±5% - 9V / 400mA ±5% - 12V / 300mA ±5%
Leistungsaufnahme im Leerlauf:	<0,1W	Stand-by power consumption:	<0,1W
Ausgangs-Schutz:	Kurzschlusschutz	Output electrical protection:	short circuit protection
Schutzart:	IP 20	Protection:	IP 20
Isolation:	4 kV Eingang/Ausgang	Insulation:	4 kV primary/secondary
Betriebstemperatur:	0°C.....+25°C	Operating temperature:	0°C.....+25°C
Lagertemperatur:	-25°C.....+70°C	Storage temperature:	-25°C.....+70°C
Gewicht:	123g inkl. Zubehör, ohne Verpackung/	Weight:	123g incl. accessories, without package
Gehäuse:	schwarzes Steckergehäuse	Case:	black plug-in case
Gehäusematerial:	ABS Kunststoffgehäuse	Case material:	ABS plastic
Zubehör:	- 1x Einstellschlüssel für Sekundärspannung - 6x Hohlstecker - 2x Klinkenstecker - 1x USB Adapter	Accessories:	- 1x key for adjustment of secondary voltage - 6x hollowplug - 2x jackplug - 1x USB adapter
Approbation:	CE	Approval:	CE
Verpackung:	farbige Faltschachtel inkl. mehrsprachiger Bedienungsanleitung	Packaging:	colorbox incl. multilingual operating instruction