

1 2 3 4 5 6 7 8 9 10 11 12 13 14

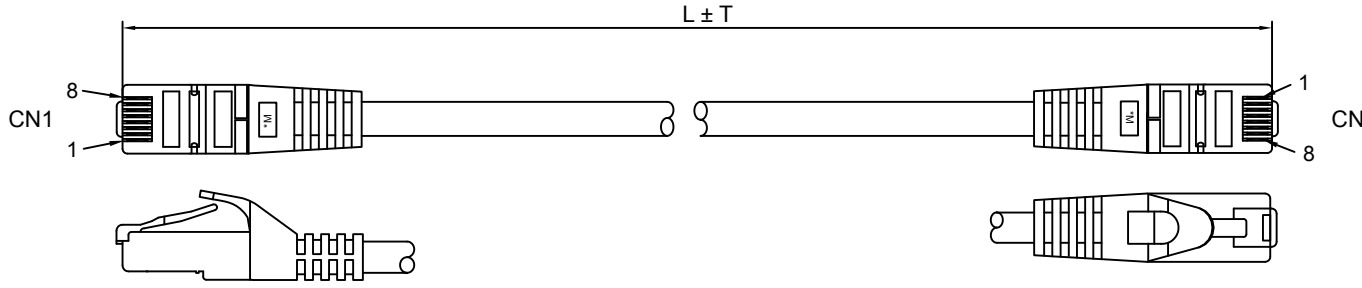

Spezifikation / Specification	CAT 6
Kabeltyp / Cable type	CAT 7 Rohkabel / round cable
Innenleiter, Material / Inner conductor material	CU (Kupfer) / CU (copper)
Innenleiter, Aderdurchmesser / Inner conductor, core diameter	(7/0.15 ± 0.005 mm)
AWG	26/7 (stranded)
Schirmungsklasse / Shielding class	S/FTP (PiMF)
Anzahl Schirmungen / Number of shieldings	2 x
Typ 1, Schirmung / Type 1, shielding	Folie (Alu) PiMF / foil (alu) PiMF
Typ 2, Schirmung / Type 2, shielding	Geflecht (Alu) Gesamtschirm / braid (alu) overall shield
Durchmesser Kabelmantel (ca.) / Cable sheath diameter (approx.)	Ø 6.2 ± 0.2 mm, LSZH
Knickschutz / Kink protection	beidseitig / both sides
LSZH-konform / LSZH compliant	ja / yes
Anschluss, Typ / Connection, type	RJ45-Stecker (8P8C) / RJ45 male (8P8C)
Anschluss, Schirmung / Connection, shielding	ja / yes
Anschluss 2, Typ / Connection 2, type	RJ45-Stecker (8P8C) / RJ45 male (8P8C)
Rastnasenschutz / Latch protection	beidseitig / both sides
max. Bandbreite / max. bandwidth	500 MHz

PIN OUT

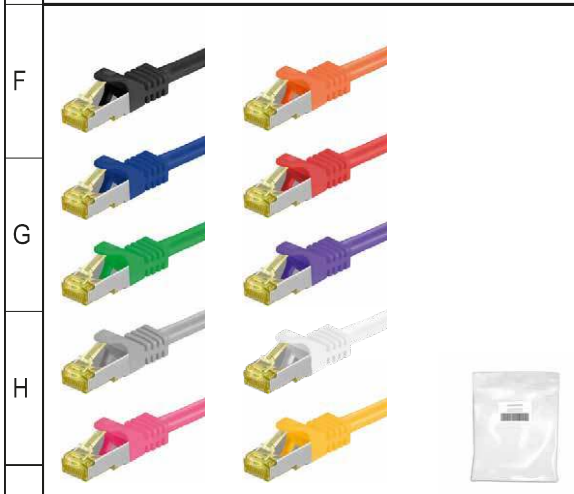
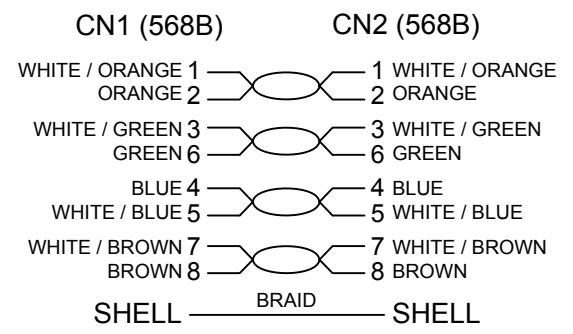

RJ45 Patchkabel CAT 6A S/FTP (PiMF) mit CAT 7 Rohkabel

- doppelt geschirmtes LAN/Netzwerkkabel zum Anschluss ihrer Netzwerkkomponenten mit 2x RJ45 (CAT 6A, 500 MHz) Steckern
- Cat 7 Rohkabel bis 600 MHz
- mit 50µ vergoldeten Kontaktflächen (PINs)
- Aderpaarschirmung: PiMF (Paare in Metall Folie) + Gesamtschirmung: Geflecht
- Längenangabe auf Slimline-Knickschutztülle
- mit Rastnasenschutz
- geeignet für Power over Ethernet (PoE/PoE+)
- Betriebstemperatur: -20 °C bis 65 °C

RJ45 patch cord CAT 6A S/FTP (PiMF), with CAT 7 raw cable

- LAN / network cable to connect network components with 2 x RJ45 (CAT 6A, 500 MHz) connectors
- Cat 7 raw cable up to 600 MHz
- with 50µ gold plated PINs
- pairs screening: PiMF (pairs in metal foil) + outer shield: braiding
- with length indication on the slimline strain relief
- with latch protection
- suitable for Power over Ethernet (PoE/PoE+)
- Operating temperature: -20 °C up to 65 °C

Änderungen		Datum	Name	Bezeichnung	Blatt
Datum	Name	gez.:	01.09.2020	sm	1 / 2
		gepr.:	01.09.2020	ac	
		Norm:		Zeichnungs-Nr.:	von
Änderungen vorbehalten / Subject to change				91089ff	





1 2 3 4 5 6 7 8 9 10 11 12 13 14



1 2 3 4 5 6 7 8 9 10 11 12 13 14



A
B
C
D
E
F
G
H

A
B
C
D
E
F
G
H

Farbe / Colour	Art.	L [m]
	schwarz / black	91572 0.25
	91581 0.50	
	91590 1.00	
	91599 1.50	
	91608 2.00	
	91617 3.00	
	91626 5.00	
	91635 7.50	
	91644 10.00	
	91653 15.00	
91662 20.00		
91671 25.00		
91680 30.00		
	blau / blue	91565 0.25
	91574 0.50	
	91583 1.00	
	91592 1.50	
	91601 2.00	
	91610 3.00	
	91619 5.00	
	91628 7.50	
	91637 10.00	
	91646 15.00	
91655 20.00		
91664 25.00		
91673 30.00		

Farbe / Colour	Art.	L [m]
	grün / green	91568 0.25
	91577 0.50	
	91586 1.00	
	91595 1.50	
	91604 2.00	
	91613 3.00	
	91622 5.00	
	91631 7.50	
	91640 10.00	
	91649 15.00	
91658 20.00		
91667 25.00		
91676 30.00		
	grau / grey	91567 0.25
	91576 0.50	
	91585 1.00	
	91594 1.50	
	91603 2.00	
	91612 3.00	
	91621 5.00	
	91630 7.50	
	91639 10.00	
	91648 15.00	
91657 20.00		
91666 25.00		
91675 30.00		

Farbe / Colour	Art.	L [m]
	magenta / magenta	91569 0.25
	91578 0.50	
	91587 1.00	
	91596 1.50	
	91605 2.00	
	91614 3.00	
	91623 5.00	
	91632 7.50	
	91641 10.00	
	91650 15.00	
91659 20.00		
91668 25.00		
91677 30.00		
	orange / orange	91570 0.25
	91579 0.50	
	91588 1.00	
	91597 1.50	
	91606 2.00	
	91615 3.00	
	91624 5.00	
	91633 7.50	
	91642 10.00	
	91651 15.00	
91660 20.00		
91669 25.00		
91678 30.00		

Farbe / Colour	Art.	L [m]
	rot / red	91571 0.25
	91580 0.50	
	91589 1.00	
	91598 1.50	
	91607 2.00	
	91616 3.00	
	91625 5.00	
	91634 7.50	
	91643 10.00	
	91652 15.00	
91661 20.00		
91670 25.00		
91679 30.00		
	violett / violett	91573 0.25
	91582 0.50	
	91591 1.00	
	91600 1.50	
	91609 2.00	
	91618 3.00	
	91627 5.00	
	91636 7.50	
	91645 10.00	
	91654 15.00	
91663 20.00		
91672 25.00		
91681 30.00		

Farbe / Colour	Art.	L [m]
	weiß / white	91089 0.25
	91090 0.50	
	91091 1.00	
	91092 1.50	
	91093 2.00	
	91094 3.00	
	91095 5.00	
	91096 7.50	
	91097 10.00	
	91098 15.00	
91099 20.00		
91100 25.00		
91101 30.00		
	gelb / yellow	91566 0.25
	91575 0.50	
	91584 1.00	
	91593 1.50	
	91602 2.00	
	91611 3.00	
	91620 5.00	
	91629 7.50	
	91638 10.00	
	91647 15.00	
91656 20.00		
91665 25.00		
91674 30.00		

Änderungen		Datum	Name	Bezeichnung	Blatt
Datum	Name	gez.: 01.09.2020	sm	CAT 7-xxxx S/FTP PIMF RJ45 LSZH x.xx m	2 / 2
		gepr.: 01.09.2020	ac		
		Norm:		Zeichnungs-Nr.:	von
Änderungen vorbehalten / Subject to change				91089ff	



1 2 3 4 5 6 7 8 9 10 11 12 13 14

J

J