

## 1A, 50V - 1000V Glass Passivated High Efficient Bridge Rectifiers

### FEATURES

- Glass passivated junction
- Ideal for printed circuit board
- Reliable low cost construction utilizing molded plastic technique
- High surge current capability
- UL Recognized File # E-326854
- Compliant to RoHS Directive 2011/65/EU and in accordance to WEEE 2002/96/EC
- Halogen-free according to IEC 61249-2-21

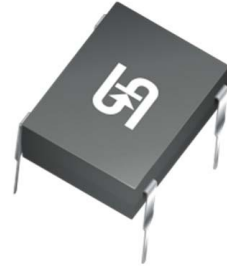

DBL



### MECHANICAL DATA

**Case:** Molded plastic body

Molding compound, UL flammability classification rating 94V-0

Part no. with suffix "H" means AEC-Q101 qualified

Packing code with suffix "G" means green compound (halogen-free)

**Terminal:** Matte tin plated leads, solderable per JESD22-B102

Meet JESD 201 class 2 whisker test

**Polarity:** Polarity as marked on the body

**Weight:** 0.36 g (approximately)

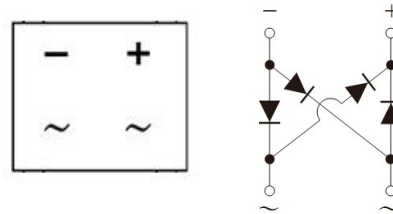

### MAXIMUM RATINGS AND ELECTRICAL CHARACTERISTICS (T<sub>A</sub>=25°C unless otherwise noted)

PARAMETER	SYMBOL	HDBL	HDBL	HDBL	HDBL	HDBL	HDBL	HDBL	UNIT
		101G	102G	103G	104G	105G	106G	107G	
Maximum repetitive peak reverse voltage	V <sub>RRM</sub>	50	100	200	400	600	800	1000	V
Maximum RMS voltage	V <sub>RMS</sub>	35	70	140	280	420	560	700	V
Maximum DC blocking voltage	V <sub>DC</sub>	50	100	200	400	600	800	1000	V
Maximum average forward rectified current	I <sub>F(AV)</sub>	1							A
Peak forward surge current, 8.3 ms single half sine-wave superimposed on rated load	I <sub>FSM</sub>	50							A
Rating for fusing (t<8.3ms)	I <sup>2</sup> t	10.3							A <sup>2</sup> s
Maximum instantaneous forward voltage (Note 1) I <sub>F</sub> = 1 A	V <sub>F</sub>	1.0		1.3		1.7			V
Maximum reverse current @ rated V <sub>R</sub> T <sub>J</sub> =25°C T <sub>J</sub> =125°C	I <sub>R</sub>	5 500							μA
Maximum reverse recovery time (Note 2)	t <sub>rr</sub>	50				75			ns
Typical thermal resistance	R <sub>θJL</sub> R <sub>θJA</sub>	15 40							°C/W
Operating junction temperature range	T <sub>J</sub>	- 55 to + 150							°C
Storage temperature range	T <sub>STG</sub>	- 55 to + 150							°C

Note 1: Pulse Test with PW=300μs, 1% Duty Cycle

Notes 2: Reverse Recovery Test Conditions: I<sub>F</sub>=0.5A, I<sub>R</sub>=1.0A, I<sub>RR</sub>=0.25A

**ORDERING INFORMATION**

PART NO.	PACKING CODE	PACKING CODE	PACKING CODE SUFFIX (*)	PACKAGE	PACKING
HDBL10xG (Note 1)	H	C1	G	DBL	50 / TUBE

Note 1: "x" defines voltage from 50V (HDBL101G) to 1000V (HDBL107G)

\*: Optional available

**EXAMPLE**

PREFERRED P/N	PART NO.	PART NO. SUFFIX	PACKING CODE	PACKING CODE SUFFIX	DESCRIPTION
HDBL107GHC1G	HDBL107G	H	C1	G	AEC-Q101 qualified Green compound

**RATINGS AND CHARACTERISTICS CURVES**

( $T_A=25^{\circ}\text{C}$  unless otherwise noted)

FIG. 1 FORWARD CURRENT DERATING CURVE

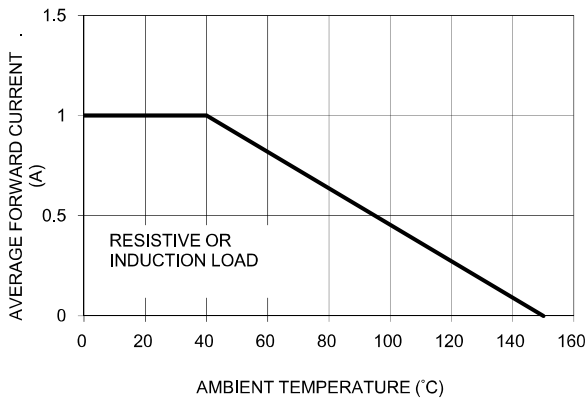

FIG. 2 TYPICAL FORWARD CHARACTERISTICS

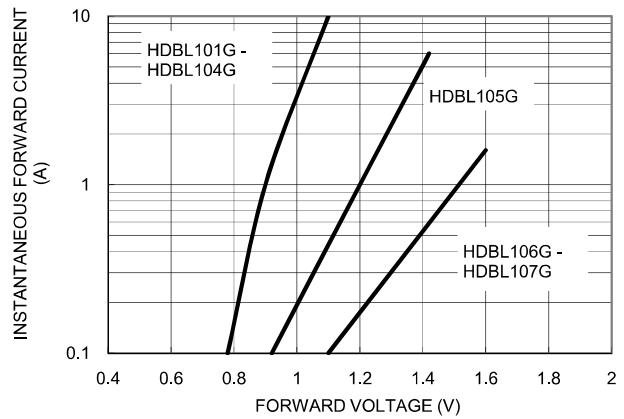

FIG. 3 MAXIMUM NON-REPETITIVE FORWARD SURGE CURRENT

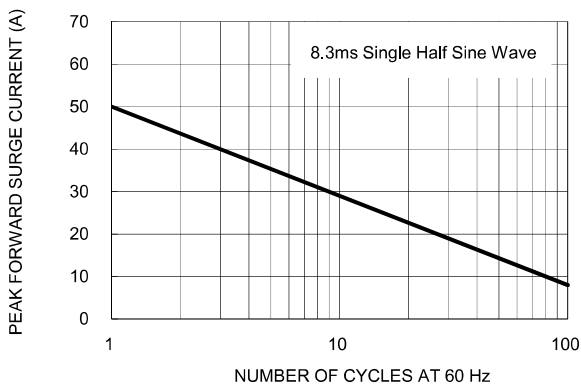

FIG. 4 TYPICAL REVERSE CHARACTERISTICS

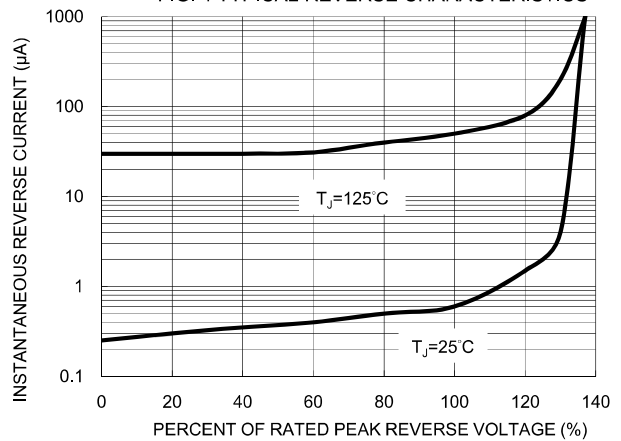

FIG. 5 TYPICAL JUNCTION CAPACITANCE

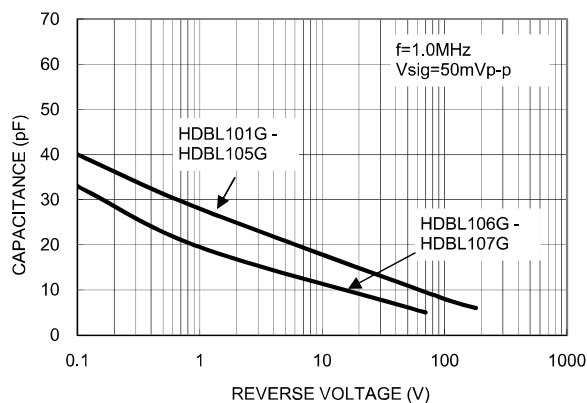
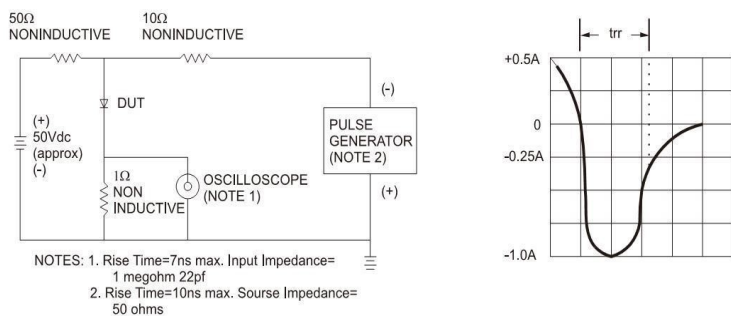
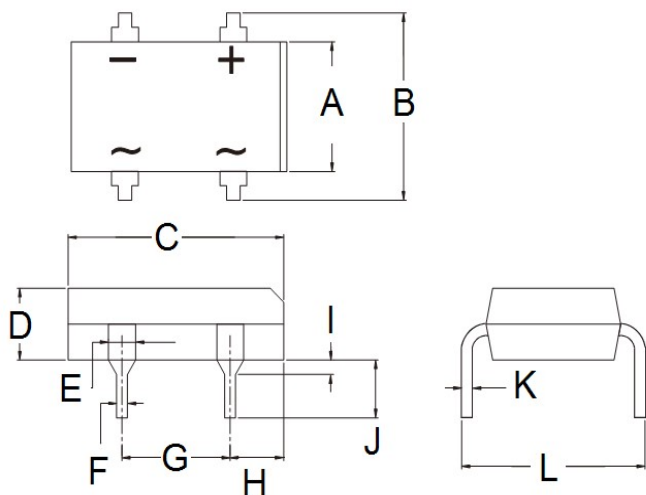

FIG.6 REVERSE RECOVERY TIME CHARACTERISTIC AND TEST CIRCUIT DIAGRAM



**PACKAGE OUTLINE DIMENSIONS**

DBL



DIM.	Unit (mm)		Unit (inch)	
	Min	Max	Min	Max
A	6.20	6.50	0.244	0.256
B	7.24	8.00	0.285	0.315
C	8.12	8.51	0.320	0.335
D	2.40	2.60	0.094	0.102
E	0.89	1.14	0.035	0.045
F	0.46	0.58	0.018	0.023
G	5.00	5.20	0.197	0.205
H	1.39	1.90	0.055	0.075
I	1.27	2.03	0.050	0.080
J	3.81	4.69	0.150	0.185
K	0.22	0.33	0.009	0.013
L	7.600	8.90	0.299	0.350

**MARKING DIAGRAM**



- P/N = Specific Device Code
- G = Green Compound
- YW = Date Code
- F = Factory Code

### **Notice**

Specifications of the products displayed herein are subject to change without notice. TSC or anyone on its behalf, assumes no responsibility or liability for any errors or inaccuracies.

Information contained herein is intended to provide a product description only. No license, express or implied, to any intellectual property rights is granted by this document. Except as provided in TSC's terms and conditions of sale for such products, TSC assumes no liability whatsoever, and disclaims any express or implied warranty, relating to sale and/or use of TSC products including liability or warranties relating to fitness for a particular purpose, merchantability, or infringement of any patent, copyright, or other intellectual property right.

The products shown herein are not designed for use in medical, life-saving, or life-sustaining applications. Customers using or selling these products for use in such applications do so at their own risk and agree to fully indemnify TSC for any damages resulting from such improper use or sale.