

# Kensington®

## Desktop & Peripherals Locking Kit 2.0

INSTRUCTION GUIDE  
GUIDE D'INSTRUCTIONS  
BEDIENUNGSANLEITUNG  
HANDLEIDING  
MANUALE DI ISTRUZIONI  
MANUAL DE INSTRUCCIONES

HASZNÁLATI ÚTMUTATÓ  
PŘÍRUČKA S POKYNY  
INSTRUKCJA OBSŁUGI  
РУКОВОДСТВО ПОЛЬЗОВАТЕЛЯ  
MANUAL DE INSTRUÇÕES

دليل التعليمات

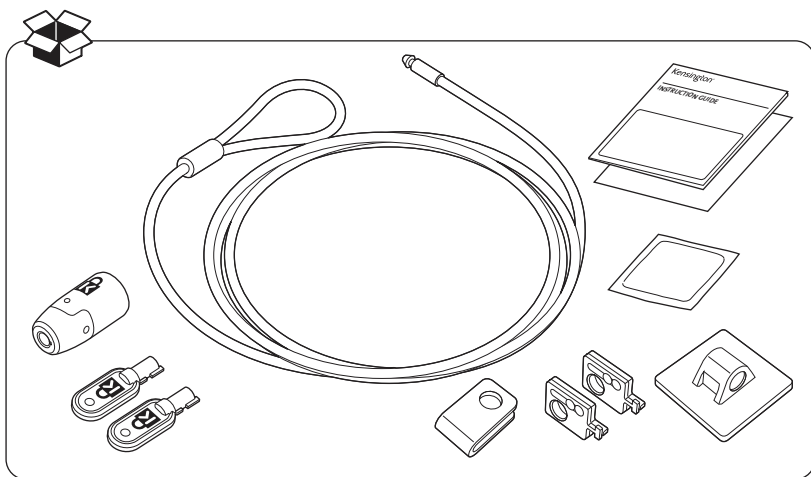

Register Now!  
Enregistrer maintenant !  
Jetzt registrieren!  
Nu registreren  
Registrar ahora  
Registra adesso

Regisztráljon most!  
Zaregistrujte se nyní!  
Zarejestruj się!  
Зарегистрироваться!  
Registe-se agora!  
سجل الآن!

[www.kensington.com/register](http://www.kensington.com/register)



IMPORTANT! REGISTER YOUR KEY CODE! /  
IMPORTANT! ENREGISTREZ VOTRE CODE CLÉ! /  
WICHTIG! REGISTRIEREN SIE IHREN KEYCODE! /  
BELANGRIJK! REGISTREER UW SLEUTELCODE! /  
IMPORTANTE! EFFETTUARE LA REGISTRAZIONE DEL  
CODICE DELLA CHIAVE /  
IMPORTANTE: REGISTRE EL CÓDIGO DE LA LLAVE /  
FONTOS! REGISZTRÁLJA A KULCSKÓDJÁT! /  
DŮLEŽITÉ! REGISTRUJTE KÓD SVÉHO KLÍČE! /  
WAŻNE! ZAREJESTRUJ KOD KLUCZYKA! /  
ВАЖНО! ЗАРЕГИСТРИРУЙТЕ СВОЙ КОД КЛЮЧА! /  
IMPORTANTE! FAÇA O REGISTO DO SEU CÓDIGO CHAVE! /  
مهم! تسجيل رمز المفتاح الخاص بك!

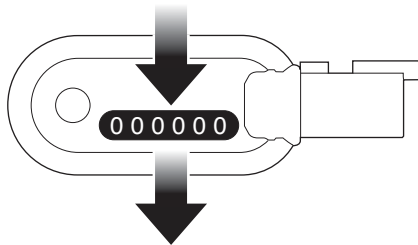

[www.kensington.com/register](http://www.kensington.com/register)

#

--	--	--	--	--	--

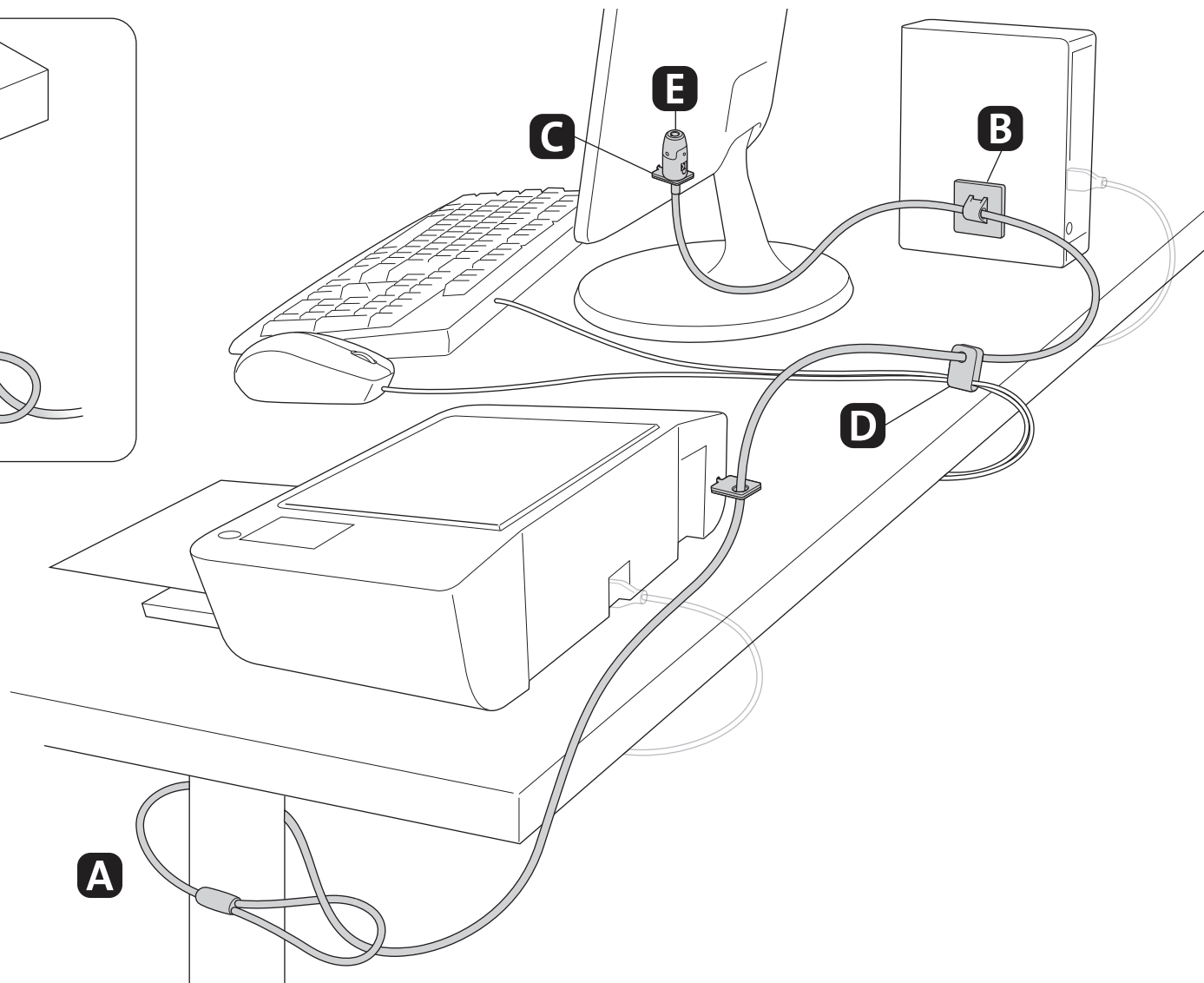
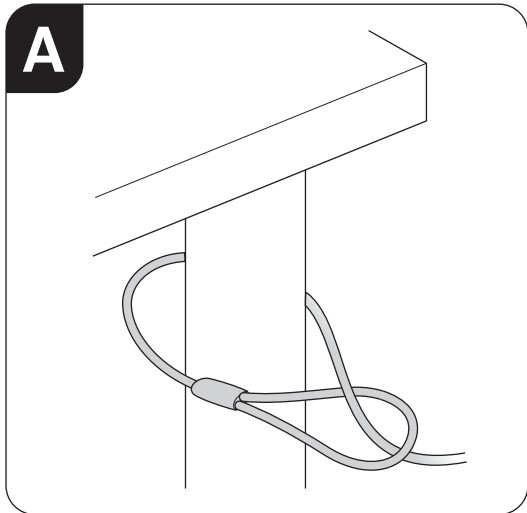

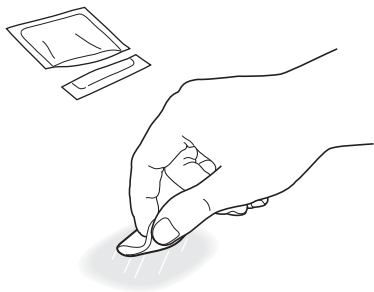
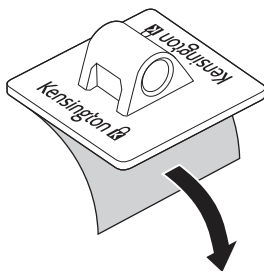
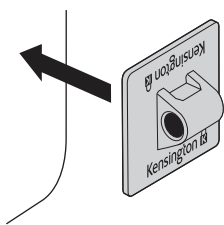
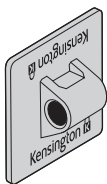
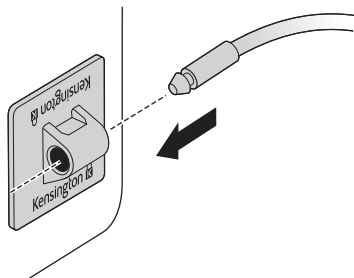
**B****1****2****3****4**

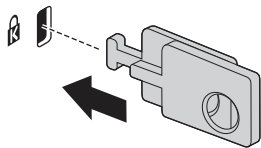
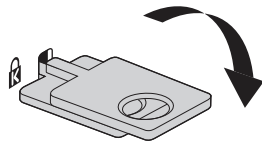
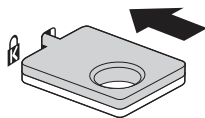
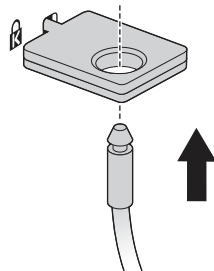
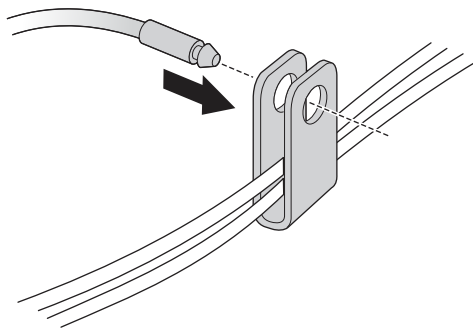
**C****1****2****3****4****D**

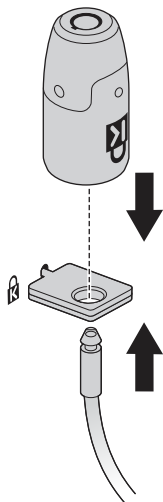
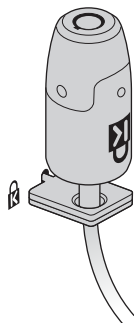
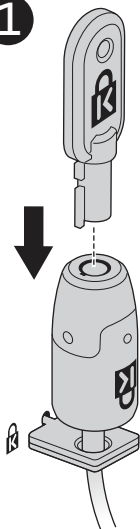
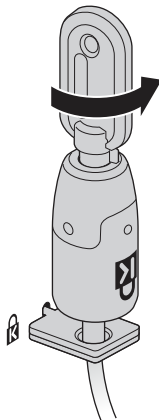
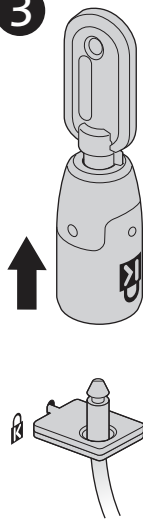
**E****1****2****1****2****3**

Sold separately. Visit [www.kensington.com](http://www.kensington.com) /  
Vendu séparément. Visitez le site [www.kensington.com](http://www.kensington.com) /  
Wird separat verkauft. Weitere Informationen finden Sie unter [www.kensington.com](http://www.kensington.com) /  
Afzonderlijk verkrijgbaar. Ga naar [www.kensington.com](http://www.kensington.com) /  
Disponibile separatamente. Visitare il sito [www.kensington.com](http://www.kensington.com) /  
Se venden por separado. Visite [www.kensington.com](http://www.kensington.com) /  
Külön értékesítve. Keresse fel a [www.kensington.com](http://www.kensington.com) /  
Lze zakoupit zvlášť. Navštivte [www.kensington.com](http://www.kensington.com) /  
Sprzedawane osobno. Odwiedź witrynę [www.kensington.com](http://www.kensington.com) /  
Продается отдельно. Более подробную информацию см. на сайте [www.kensington.com](http://www.kensington.com) /  
Vendido em separado. Visite [www.kensington.com](http://www.kensington.com) /  
[www.kensington.com](http://www.kensington.com) يُباع بشكل منفصل. تفضل بزيارة

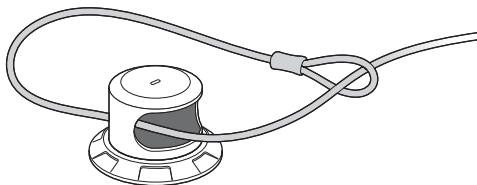

**K64162**

---

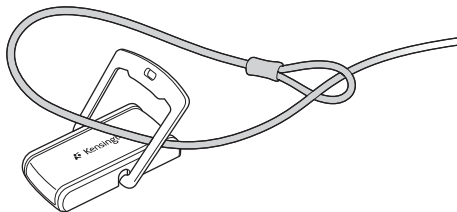

**K64163**

---

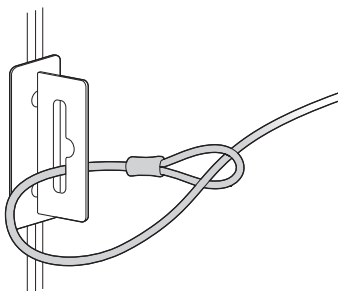

**K67700**

Kensington and the ACCO name and design are registered trademarks of ACCO Brands. All other registered and unregistered trademarks are the property of their respective owners.

©2017 Kensington Computer Products Group, a division of ACCO Brands. Any unauthorized copying, duplicating, or other reproduction of the contents hereof is prohibited without written consent from Kensington Computer Products Group. All rights reserved. 02/17



**Kensington Computer Products Group**  
**A Division of ACCO Brands**  
1500 Fashion Island Blvd, 3rd Floor  
San Mateo, CA 94404



**ACCO Brands Europe**  
A Division of ACCO Brands Europe  
Oxford House, Oxford Road  
Aylesbury, Buckinghamshire,  
HP21 8SZ  
United Kingdom

**ACCO Brands Canada Inc**  
7381 Bramalea Rd  
Mississauga,  
ON L5S 1C4  
Canada

**ACCO Brands Australia - Kensington**  
2 Coronation Avenue  
Kings Park NSW 2148  
Australia

**Importado por ACCO Mexicana**  
**S.A. de C.V.**  
Circuito de la Industria Norte # 6,  
Corredor Industrial Toluca Lerma,  
Lerma México Cp. 52004  
R.F.C. AME640229-1W3

**Acco Brands Chile S.A.,**  
Avda. San Josemaria  
Escrivá de Balaguer N°5773  
Vitacura, C.P. 7640970  
Santiago, Chile

**Importado e Distribuído por:**  
TILIBRA PRODUTOS DE PAPELARIA LTDA.  
CNPJ: 44.990.901/0001-43  
Rua Aymorés, 6-9 – Bauru/SP – Brasil  
CEP 17013-900

[www.kensington.com](http://www.kensington.com)

K64424/K64425/K67990

901-9318-00