

1 2 3 4 5 6 7 8 9 10 11 12 13 14

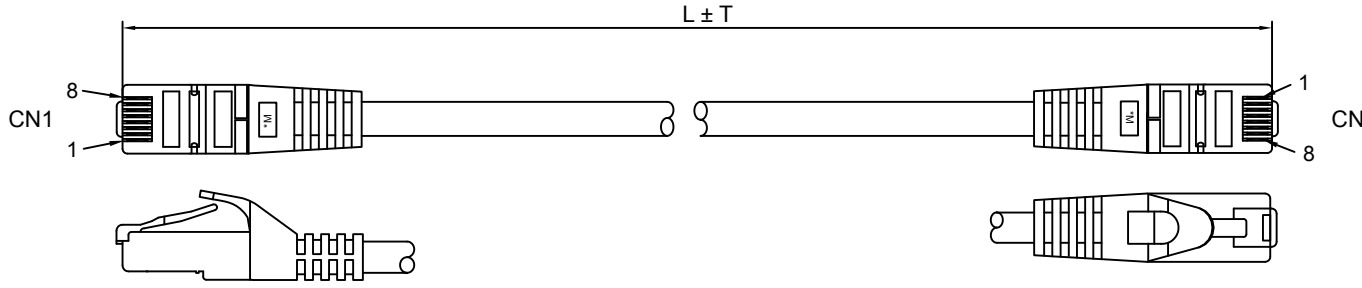

Spezifikation / Specification	CAT 6
Kabeltyp / Cable type	CAT 7 Rohkabel / round cable
Innenleiter, Material / Inner conductor material	CU (Kupfer) / CU (copper)
Innenleiter, Aderdurchmesser / Inner conductor, core diameter	(7/0.15 ± 0.005 mm)
AWG	26/7 (stranded)
Schirmungsklasse / Shielding class	S/FTP (PiMF)
Anzahl Schirmungen / Number of shieldings	2 x
Typ 1, Schirmung / Type 1, shielding	Folie (Alu) PiMF / foil (alu) PiMF
Typ 2, Schirmung / Type 2, shielding	Geflecht (Alu) Gesamtschirm / braid (alu) overall shield
Durchmesser Kabelmantel (ca.) / Cable sheath diameter (approx.)	Ø 6.2 ± 0.2 mm, LSZH
Knickschutz / Kink protection	beidseitig / both sides
LSZH-konform / LSZH compliant	ja / yes
Anschluss, Typ / Connection, type	RJ45-Stecker (8P8C) / RJ45 male (8P8C)
Anschluss, Schirmung / Connection, shielding	ja / yes
Anschluss 2, Typ / Connection 2, type	RJ45-Stecker (8P8C) / RJ45 male (8P8C)
Rastnasenschutz / Latch protection	beidseitig / both sides
max. Bandbreite / max. bandwidth	500 MHz

PIN OUT

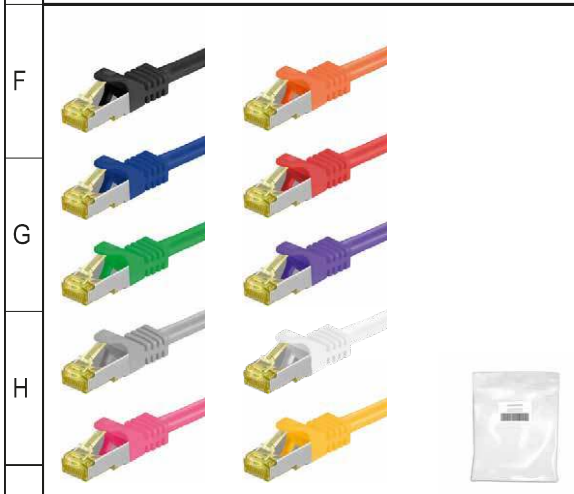
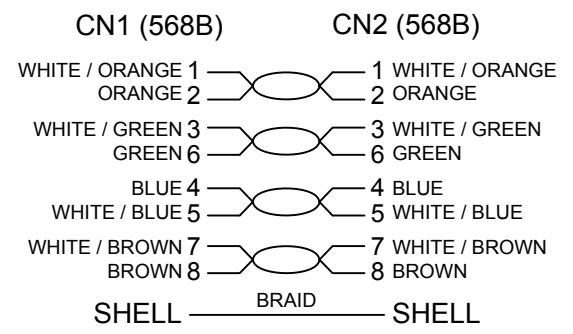

RJ45 Patchkabel CAT 6A S/FTP (PiMF) mit CAT 7 Rohkabel

- doppelt geschirmtes LAN/Netzwerkkabel zum Anschluss ihrer Netzwerkkomponenten mit 2x RJ45 (CAT 6A, 500 MHz) Steckern
- Cat 7 Rohkabel bis 600 MHz
- mit 50µ vergoldeten Kontaktflächen (PINs)
- Aderpaarschirmung: PiMF (Paare in Metall Folie) + Gesamtschirmung: Geflecht
- Längenangabe auf Slimline-Knickschutzülle
- mit Rastnasenschutz
- geeignet für Power over Ethernet (PoE/PoE+)
- Betriebstemperatur: -20 °C bis 65 °C









RJ45 patch cord CAT 6A S/FTP (PiMF), with CAT 7 raw cable

- LAN / network cable to connect network components with 2 x RJ45 (CAT 6A, 500 MHz) connectors
- Cat 7 raw cable up to 600 MHz
- with 50µ gold plated PINs
- pairs screening: PiMF (pairs in metal foil) + outer shield: braiding
- with length indication on the slimline strain relief
- with latch protection
- suitable for Power over Ethernet (PoE/PoE+)
- Operating temperature: -20 °C up to 65 °C

Änderungen		Datum	Name	Bezeichnung	Blatt
Datum	Name	gez.:	01.09.2020	sm	1 / 2
		gepr.:	01.09.2020	ac	
		Norm:		Zeichnungs-Nr.:	von
Änderungen vorbehalten / Subject to change				91089ff	



1 2 3 4 5 6 7 8 9 10 11 12 13 14

	1	2	3	4	5	6	7	8	9	10	11	12	13	14										
A	Farbe / Colour			Art.	L [m]	Farbe / Colour			Art.	L [m]	Farbe / Colour			Art.	L [m]									
B				schwarz / black	91572	0.25				grün / green	91568	0.25				rot / red	91571	0.25				weiß / white	91089	0.25
C				91581	0.50	91577				0.50	91578	0.50				91580	0.50							
D				91590	1.00	91586				1.00	91587	1.00				91589	1.00							
E				91599	1.50	91595				1.50	91596	1.50				91598	1.50							
F				91608	2.00	91604				2.00	91605	2.00				91607	2.00							
G				91617	3.00	91613				3.00	91614	3.00				91616	3.00							
H				91626	5.00	91622				5.00	91623	5.00				91625	5.00							
I				91635	7.50	91631				7.50	91632	7.50				91634	7.50							
J				91644	10.00	91640				10.00	91641	10.00				91643	10.00							
				91653	15.00	91649				15.00	91650	15.00				91652	15.00							
				91662	20.00	91658				20.00	91659	20.00				91661	20.00							
				91671	25.00	91667				25.00	91668	25.00				91670	25.00							
				91680	30.00	91676				30.00	91677	30.00				91679	30.00							
A	blau / blue			91565	0.25	orange / orange			91570	0.25	violett / violett			91573	0.25	gelb / yellow			91566	0.25				
B				91574	0.50				91579	0.50				91582	0.50				91575	0.50				
C				91583	1.00				91585	1.00				91588	1.00				91591	1.00				
D				91592	1.50				91594	1.50				91597	1.50				91600	1.50				
E				91601	2.00				91603	2.00				91606	2.00				91609	2.00				
F				91610	3.00				91612	3.00				91615	3.00				91618	3.00				
G				91619	5.00				91621	5.00				91624	5.00				91627	5.00				
H				91628	7.50				91630	7.50				91633	7.50				91636	7.50				
I				91637	10.00				91639	10.00				91642	10.00				91645	10.00				
J				91646	15.00				91648	15.00				91651	15.00				91654	15.00				
				91655	20.00				91657	20.00				91660	20.00				91663	20.00				
				91664	25.00				91666	25.00				91669	25.00				91672	25.00				
				91673	30.00				91675	30.00				91678	30.00				91681	30.00				
Änderungen				Datum	Name				Bezeichnung						Blatt									
Datum				gez.:	01.09.2020	sm	CAT 7-xxxx S/FTP PIMF RJ45																	
Name				gepr.:	01.09.2020	ac	LSZH x.xx m																	
				Norm:	Zeichnungs-Nr.:						von													
				Änderungen vorbehalten / Subject to change						91089ff														
1	2	3	4	5	6	7	8	9	10	11	12	13	14											