

- en** 1 T time delay range
- 2 T time delay setting
- 3 Function selection
- 4 LED Indication (Except solid state output)
- de** 1 Verzögerungsbereich T
- 2 Verzögerungseinstellung T
- 3 Funktionsauswahl
- 4 LED-Anzeige (außer Halbleiterausgang)
- it** 1 Gamma di temporizzazione T
- 2 Regolazione temporizzazione T
- 3 Selezione funzione
- 4 Indicazione LED (eccetto uscita statica)

- fr** 1 Gamme de temporisation T
- 2 Réglage temporisation T
- 3 Sélection de fonction
- 4 Voyant (sauf la sortie statique)
- es** 1 Gama de temporización T
- 2 Reglaje temporización T
- 3 Selección de la función
- 4 Indicador LED (excepto la salida de estado sólido)
- zh** 1 时间范围的确定 T
- 2 延时时间设定 T
- 3 功能选择
- 4 LED 指示 (固态输出除外)

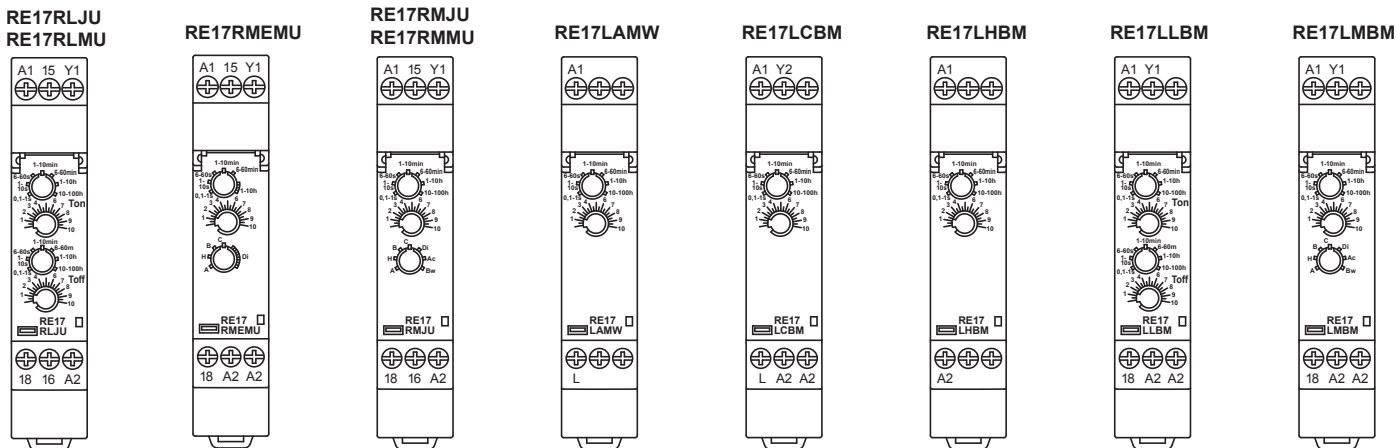
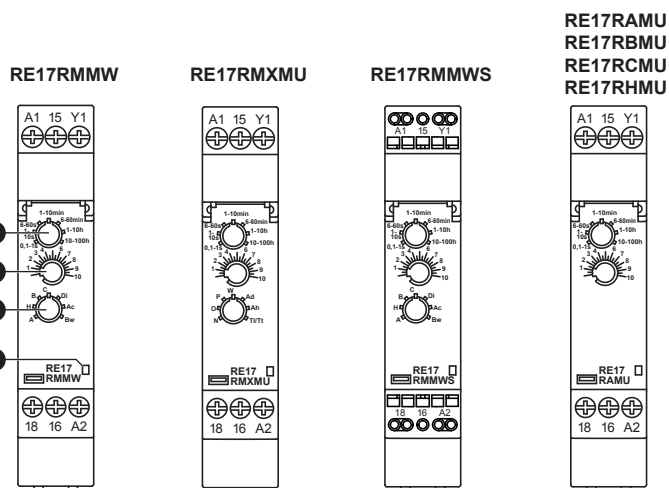

Functions / Fonctions / Funktionen / Funciones / Funzione / 功能

- en** U: Supply
- R: Relay or solid state output
- T: Timing period
- C: Control contact
- G: Gate
- Ta: Adjustable On-delay
- Tr: Adjustable Off-delay

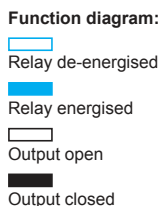

- fr** U: Alimentation
- R: Sortie relais ou statique
- T: Temporisation
- C: Commande
- G: Porte (Gate)
- Ta: Temporisation travail réglable
- Tr: Temporisation repos réglable

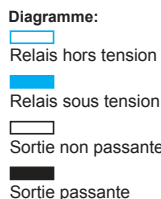

- de** U: Spannungsversorgung
- R: R: Relais- oder Halbleiterausgang
- T: Verzögerung
- C: Steuerkontakt
- G: Logikgatter
- Ta: Einstellbare Ansprechverzögerung
- Tr: Einstellbare Rückfallverzögerung

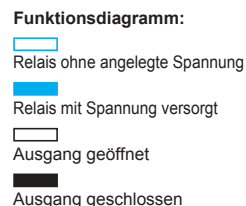

- es** U: Alimentación
- R: Salida de estado sólido o relé
- T: Período de temporización
- C: Contacto de control
- G: Puerta
- Ta: Retardo de conexión ajustable
- Tr: Retardo de desconexión ajustable

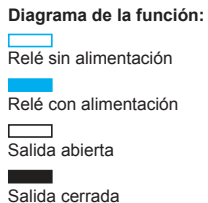

- it** U: Alimentazione
- R: Uscita relé o statica
- T: Temporizzazione
- C: Comando
- G: Porta (Gate)
- Ta: Temporizzazione funzionamento regolabile
- Tr: Temporizzazione riposo regolabile

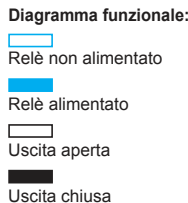

- zh** U: 电源
- R: 继电器或固态输出
- T: 定时时段
- C: 控制触点
- G: 门
- Ta: 可调节接通延迟
- Tr: 可调节断开延迟

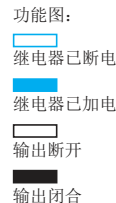

- A** RE17RMMW RE17RMJU RE17RMMWS RE17RMMU RE17RAMU RE17LAMW RE17RMEMU RE17LMBM
- en** Power on delay relay
  - fr** Relais temporisé à la mise sous tension
  - de** Ansprechverzögertes Zeitrelais
  - es** Relé de retardo de arranque
  - it** Relè ritardato all'accensione
  - zh** 开启延迟继电器电源

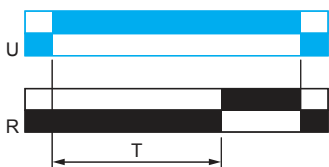

- Ac** RE17RMMW RE17RMJU RE17LMBM RE17RMMWS RE17RMMU
- en** On- and off-delay relay with control signal
  - fr** Relais de temporisation travail et repos avec signal de contrôle
  - de** Ansprech- und rückfallverzögertes Zeitrelais mit Steuersignal
  - es** Relé de retardo de conexión y desconexión con señal de control
  - it** Relè ritardato all'inserzione e alla disinserzione con segnale di comando
  - zh** 具有控制信号的接通-断开延迟继电器

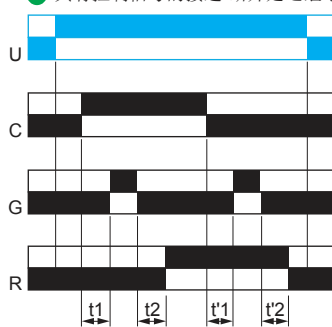

$T = t_1 + t_2 + \dots$   
 $T = t_1' + t_2' + \dots$

- Ad** RE17RXXMU
- en** Pulse delayed relay with control signal
  - fr** Relais à impulsion temporisée avec signal de contrôle
  - de** Impulsverzögertes Zeitrelais mit Steuersignal
  - es** Relé de retardo de pulso con señal de control
  - it** Relè a impulso ritardato con segnale di comando
  - zh** 具有控制信号的脉冲延迟继电器

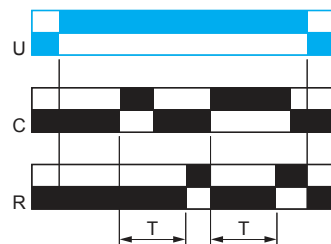

**Ah** RE17RMXMU

- en Pulse delayed relay (single cycle) with control signal
- fr Relais à impulsion temporisée (un seul cycle) avec signal de contrôle
- de Impulsverzögertes Zeitrelais (einfacher Zyklus) mit Steuersignal
- es Relé de retardo de pulso (ciclo único) con señal de control
- it Relè a impulso ritardato (ciclo singolo) con segnale di comando
- zh 具有控制信号的脉冲延迟继电器 (单循环)

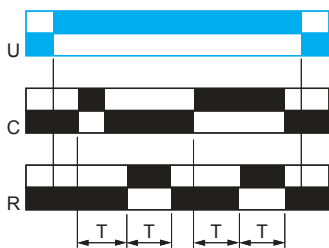

**At** RE17RMMW RE17RMJU  
RE17RMMWS RE17RMMU  
RE17RAMU RE17LMBM  
RE17RMEMU

- en Power on delay relay (summation) with control signal
- fr Relais temporisé à la mise sous tension (somme) avec signal de contrôle
- de Ansprechverzögertes Zeitrelais (additiv) mit Steuersignal
- es Relé de retardo de arranque (suma) con señal de control
- it Relè ritardato all'accensione (somma) con segnale di comando
- zh 开启具有控制信号的延迟继电器 (求和) 电源

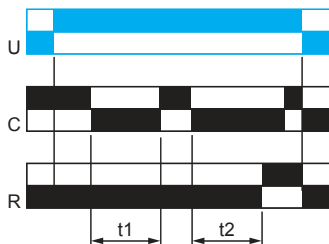

$T = t1 + t2 + \dots$

**B** RE17RMMW RE17RMJU  
RE17RMMWS RE17RMMU  
RE17RBMU RE17LMBM  
RE17RMEMU

- en Interval relay with control signal
- fr Relais d'intervalle avec signal de contrôle
- de Wischrelais mit Steuersignal
- es Relé de intervalo con señal de control
- it Relè a intervallo con segnale di comando
- zh 具有控制信号的间隔定时继电器

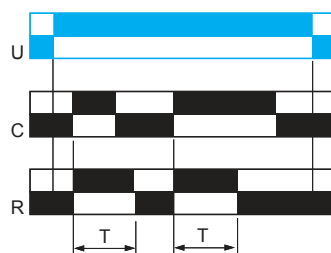

**Bw** RE17RMMW RE17RMMU  
RE17RMMWS RE17LMBM  
RE17RMJU

- en Double interval relay with control signal
- fr Relais d'intervalle double avec signal de contrôle
- de Doppeltes Wischrelais mit Steuersignal
- es Relé de intervalo doble con señal de control
- it Relè a doppio intervallo con segnale di comando
- zh 具有控制信号的双间隔定时继电器

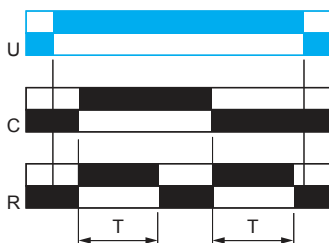

**C** RE17RMMW RE17RMJU  
RE17RMMWS RE17RMMU  
RE17RCMU RE17LCBM  
RE17RMEMU RE17LMBM

- en Off-delay relay with control signal
- fr Relais de temporisation repos avec signal de contrôle
- de Rückfallverzögertes Zeitrelais mit Steuersignal
- es Relé de retardo de desconexión con señal de control
- it Relè ritardato alla disinserzione con segnale di comando
- zh 具有控制信号的断开延迟继电器

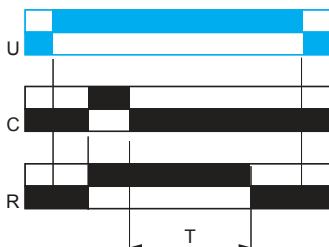

**D** RE17RMMW RE17RMJU  
RE17RMMWS RE17RMMU  
RE17RMEMU RE17LMBM

- en Symmetrical flasher relay (starting pulse off)
- fr Relais de clignotant symétrique (impulsion de départ repos)
- de Symmetrisches Blinkrelais (pausebeginnend)
- es Relé señalizador simétrico (pulso inicial desconectado)
- it Relè a intermittenza simmetrica (impulso avvio off)
- zh 对称式闪光继电器 (启动脉冲停止)



**Di** RE17RMMW RE17RMMU  
RE17RMMWS RE17LMBM  
RE17RMEMU  
RE17RMJU

- en Symmetrical flasher relay (starting pulse on)
- fr Relais de clignotant symétrique (impulsion de départ travail)
- de Symmetrisches Blinkrelais (impulsbeginnend)
- es Relé señalizador simétrico (pulso inicial conectado)
- it Relè a intermittenza simmetrica (impulso avvio on)
- zh 对称式闪光继电器 (启动脉冲开启)



**H** RE17RMMW RE17RMJU  
RE17RMMWS RE17RMMU  
RE17RHMU RE17LHBM  
RE17RMEMU RE17LMBM

- en Interval relay
- fr Relais d'intervalle
- de Wischrelais
- es Relé de intervalo
- it Relè intervallo
- zh 间隔定时继电器

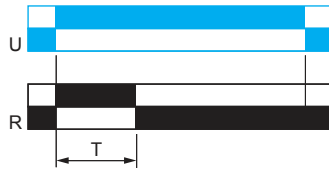

**Ht** RE17RMMW RE17RMJU  
RE17RMMWS RE17RMMU  
RE17RHMU RE17LMBM  
RE17RMEMU

- en Interval relay (summation) with control signal
- fr Relais d'intervalle (somme) avec signal de contrôle
- de Wischrelais (additiv) mit Steuersignal
- es Relé de intervalo (suma) con señal de control
- it Relè a intervallo (somma) con segnale di comando
- zh 具有控制信号的间隔定时继电器 (求和)

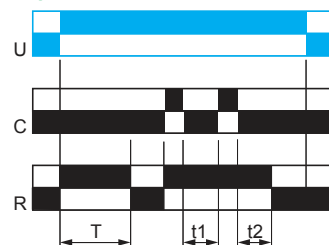

$T = t1 + t2 + \dots$

**L** RE17RLJU  
RE17RLMU  
RE17LLBM

- en Asymmetrical flasher relay (starting pulse off)
- fr Relais de clignotant asymétrique (impulsion de départ repos)
- de Asymmetrisches Blinkrelais (pausebeginnend)
- es Relé señalizador asimétrico (pulso inicial desconectado)
- it Relè a intermittenza asimmetrica (impulso avvio off)
- zh 非对称式闪光继电器 (启动脉冲停止)

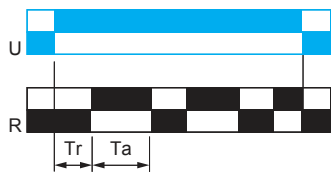

**Li** RE17RLJU  
RE17RLMU  
RE17LLBM

- en Asymmetrical flasher relay (starting pulse on)
- fr Relais de clignotant asymétrique (impulsion de départ travail)
- de Asymmetrisches Blinkrelais (impulsbeginnend)
- es Relé señalizador asimétrico (pulso inicial conectado)
- it Relè a intermittenza asimmetrica (impulso avvio on)
- zh 非对称式闪光继电器 (启动脉冲开启)

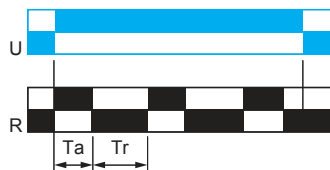

**N** RE17RMXMU

- en Retriggerable interval relay with control signal on
- fr Relais d'intervalle redéclenchable avec signal de contrôle travail
- de Nachtriggerbares Wischrelais mit Steuersignal
- es Relé de intervalo redisparable con señal de control activada
- it Relè a intervallo ripristinabile all'invio del segnale di comando
- zh 开启控制信号的可再触发式间隔定时继电器

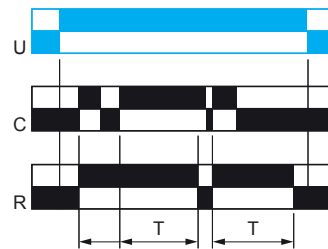

**O** RE17RMXMU

- en Retriggerable interval delayed relay with control signal on
- fr Relais temporisé d'intervalle redéclenchable avec signal de contrôle travail
- de Nachtriggerbares intervallverzögertes Zeitrelais mit Steuersignal
- es Relé de retardo de intervalo redisparable con señal de control activada
- it Relè a intervallo ritardato ripristinabile all'invio del segnale di comando
- zh 开启控制信号的可再触发式间隔延迟继电器

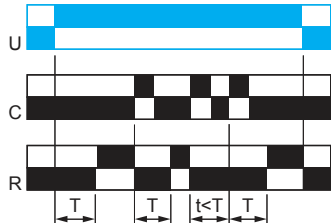

**P** RE17RMXMU

- en Pulse delayed relay with fixed pulse length
- fr Relais à impulsion temporisée avec longueur d'impulsion fixe
- de Impulsverzögertes Zeitrelais mit fester Impulslänge
- es Relé de retardo de pulso con duración fija del pulso
- it Relè a impulso ritardato con lunghezza impulso fissa
- zh 具有混合脉冲长度的脉冲延迟继电器

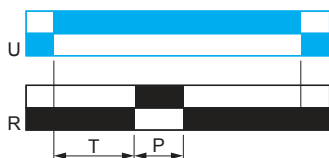

P = 500 ms

**Pt** RE17RMXMU

- en Pulse delayed relay (summation and fixed pulse length) with control signal off
- fr Relais à impulsion temporisée (somme et longueur d'impulsion fixe) avec signal de contrôle repos
- de Impulsverzögertes Zeitrelais (additiv und feste Impulslänge) ohne Steuersignal
- es Relé con retardo de pulso (suma y duración fija de pulso) con señal de control desactivada
- it Relè a impulso ritardato (somma e lunghezza impulso fissa) senza segnale di comando
- zh 关闭控制信号的脉冲延迟继电器 (求和和混合脉冲长度)

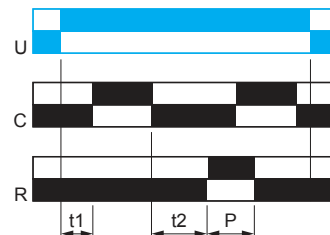

T = t1 + t2 + ...  
P = 500 ms

**T** RE17RMXMU

- en Bistable relay with control signal on
- fr Relais bistable avec signal de contrôle travail
- de Bistabiles Relais mit Steuersignal
- es Relé biestable con señal de control activada
- it Relè bistabile con invio segnale di comando
- zh 开启控制信号的双稳态继电器

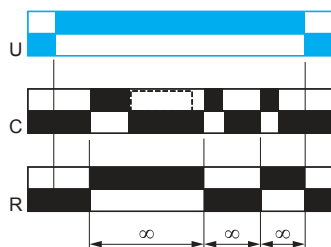

**Tt** RE17RMXMU

- en Retriggerable bistable relay with control signal on
- fr Relais bistable redéclenchable avec signal de contrôle travail
- de Nachtriggerbares bistabiles Relais mit Steuersignal
- es Relé biestable redisparable con señal de control activada
- it Relè bistabile ripristinabile all'invio del segnale di comando
- zh 开启控制信号的可再触发式双稳态继电器

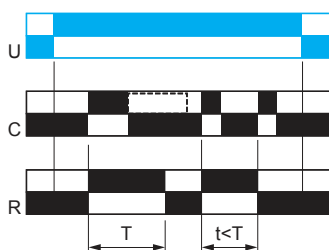

**W** RE17RMXMU

- en Interval relay with control signal off
- fr Relais d'intervalle avec signal de contrôle repos
- de Wischrelais ohne Steuersignal
- es Relé de intervalo con señal de control desactivada
- it Relè a intervallo senza segnale di comando
- zh 关闭控制信号的间隔定时继电器

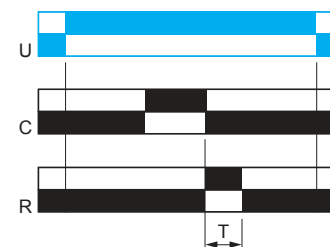

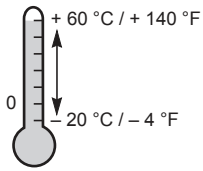

RE17RMMW  
RE17RMMWS

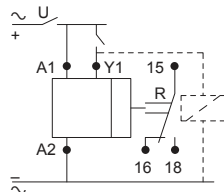

U	12...240 Vdc 1,5 W
U	12...240 Vac 50...60 Hz 3 VA
	250 Vac / 8 A

RE17RAMU

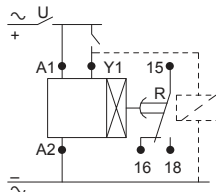

U	24 Vdc 0.6 W
U	24...240 Vac 50...60 Hz 32 VA
	250 Vac / 8 A

RE17RHMU

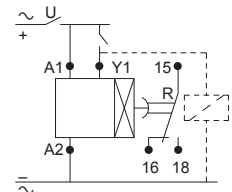

U	24 Vdc 0.6 W
U	24...240 Vac 50...60 Hz 32 VA
	250 Vac / 8 A

RE17RBMU  
RE17RCMU

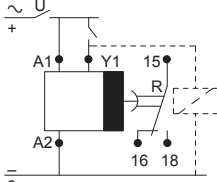

U	24 Vdc 0.6 W
U	24...240 Vac 50...60 Hz 32 VA
	250 Vac / 8 A

RE17RLJU

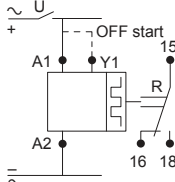

U	12 Vdc 0.5 W
U	12 Vac 50...60 Hz 0.7 VA
	250 Vac / 8 A

RE17RLMU

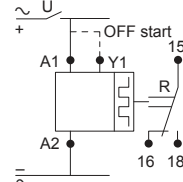

U	24 Vdc 0.6 W
U	24...240 Vac 50...60 Hz 32 VA
	250 Vac / 8 A

RE17RMXMU  
RE17RMEMU  
RE17RMMU

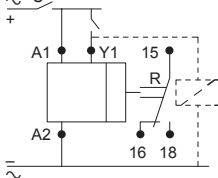

U	24 Vdc 0.6 W
U	24...240 Vac 50...60 Hz 32 VA
	250 Vac / 8 A

RE17RMJU

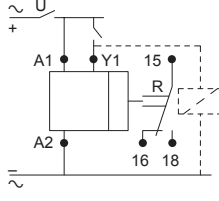

U	12 Vdc 0.5 W
U	12 Vac 50...60 Hz 0.7 VA
	250 Vac / 8 A

RE17LAMW

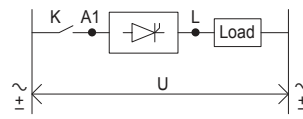

U	24...240 Vdc
U	24...240 Vac 50...60 Hz
	0.7 A (20 °C)

RE17LHBM

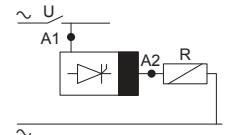

U	24...240 Vac 50...60 Hz
	0.7 A (20 °C)

RE17LLBM

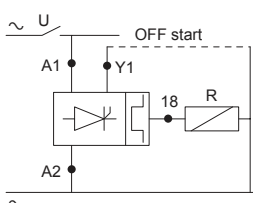

U	24...240 Vac 50...60 Hz
	0.7 A (20 °C)

RE17LMBM

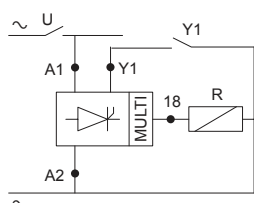

U	24...240 Vac 50...60 Hz
	0.7 A (20 °C)

RE17LCBM

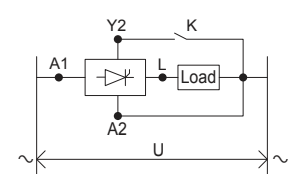

U	24...240 Vac 50...60 Hz
	0.7 A (20 °C)

### Wire sizes and torque / Calibre de fils et couple / Drahtstärken und Anzugsmoment / Tamaños de cable y par de apriete / Sezioni filo e coppia / 电线尺寸和扭矩

All references except RE17RMMWS / Toutes les références sauf RE17RMMWS / Alle Referenzen außer RE17RMMWS / Todas las referencias excepto RE17RMMWS / Tutti i prodotti eccetto RE17RMMWS / 所有参考 (RE17RMMWS 除外)

mm in.					
mm <sup>2</sup>	0.5...3.33	0.5...2.5	0.2...2.5	0.2...1.5	
AWG	20...12	20...14	24...14	24...16	

		N•m	0.6...1
Ø 3,5 mm / 0.14 in.		lb-in	5.3...8.8

Only for RE17RMMWS (spring terminals) / Uniquement pour RE17RMMWS (bornes à ressort) / Nur für RE17RMMWS (Federklemmen) / Solo RE17RMMWS (terminales de resorte) / Solo per RE17RMMWS (morsetti a molla) / 仅适用于 RE17RMMWS (弹簧端子)

mm in.			
mm <sup>2</sup>	0.2...1.5	0.2...1.5	
AWG	24...16	24...16	

• Flathead screwdriver, Parallel tip / Tournevis plat, pointe parallèle / Flachkopf-Schraubendreher, parallele Spitze / Destornillador de cabeza plana, punta paralela / Cacciavite a testa piatta, punta parallela / 一字螺丝刀, 平行尖端

• Flathead screwdriver, Flared tip / Tournevis plat, pointe évasée / Flachkopf-Schraubendreher, aufgeweitete Spitze / Destornillador de cabeza plana, punta ancha / Cacciavite a testa piatta, punta svasata / 一字螺丝刀, 外展尖端

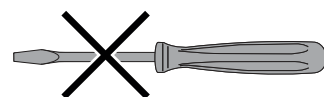
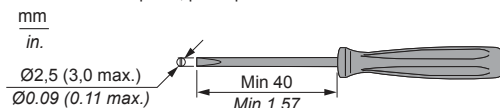

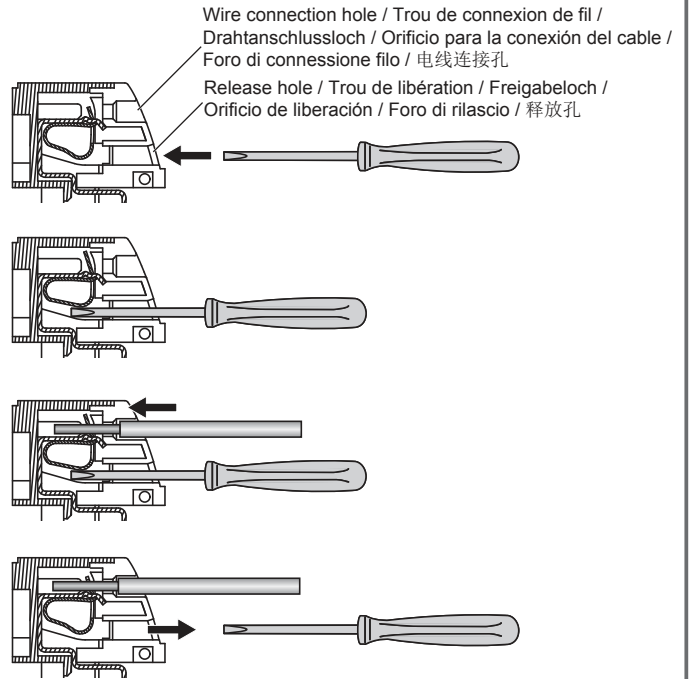
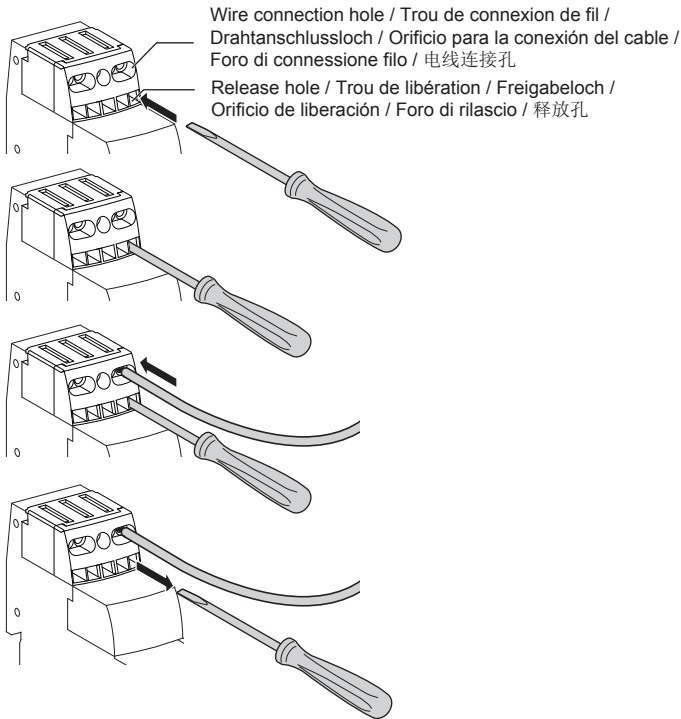

### 3 Set / Réglez / Einstellung / Regule / Regolate / 设定

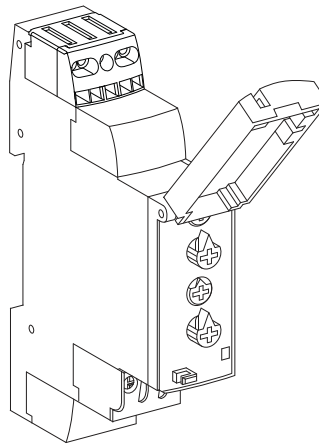
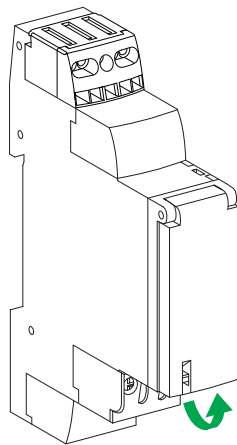

T ≤ 10 min 分钟

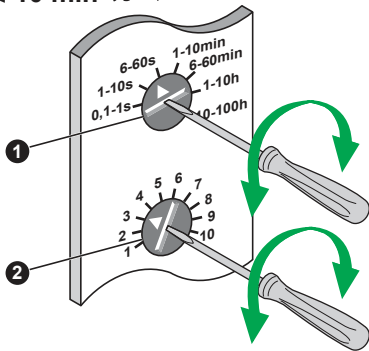

T ≥ 10 min 分钟

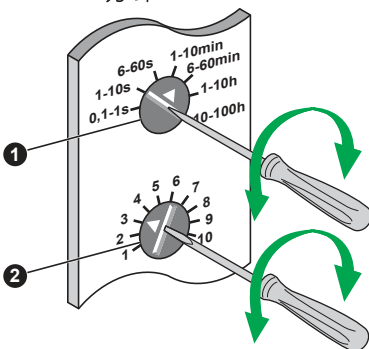

Example / Exemple / Biespiel / Ejemplo / Esempio / 例子

	①	➔	②
T = 60 s			
T = 45 s			

NOT RECOMMENDED /  
NON RECOMMANDÉ /  
NICHT EMPFOHLEN /  
NO RECOMENDADO /  
NON CONSIGLIATO /  
不建议

Example / Exemple / Biespiel / Ejemplo / Esempio / 例子

	①	➔	②	➔	①
T = 7 h 00					

**⚠ ⚠ DANGER / DANGER / GEFAHR / PERICOLO / PELIGRO / 危险**

<p><b>HAZARD OF ELECTRIC SHOCK, EXPLOSION OR ARC FLASH</b></p> <ul style="list-style-type: none"> <li>• Disconnect all power before servicing equipment.</li> <li>• Confirm that the product power supply voltage and its tolerances are compatible with those of the network.</li> </ul> <p><b>Failure to follow these instructions will result in death or serious injury.</b></p>	<p><b>RISQUE D'ELECTROCUTION, D'EXPLOSION OU D'ARC ELECTRIQUE</b></p> <ul style="list-style-type: none"> <li>• Coupez l'alimentation avant de travailler sur cet appareil.</li> <li>• Assurez-vous que la tension d'alimentation du produit, avec ses tolérances, est compatible avec celle du réseau.</li> </ul> <p><b>Le non-respect de cette instruction entraînera la mort ou des blessures graves.</b></p>	<p><b>STROMSCHLAG-, EXPLOSIONS- ODER LICHTBOGENGEFAHR</b></p> <ul style="list-style-type: none"> <li>• Vor dem Arbeiten an dem Gerätessen Stromversorgung abschalten.</li> <li>• Stelle Sie sicher, dass die Versorgungsspannung des Produkts einschließlich Toleranzen mit den Netzbedingungen vereinbar ist.</li> </ul> <p><b>Die Nichtbeachtung dieser Anweisung wird den Tod oderschwere Körperverletzung zur Folge haben.</b></p>
<p><b>RISCHIO DI SCOSSA ELETTRICA, DI ESPLOSIONE O DI OFTALMIA DA FLASH</b></p> <ul style="list-style-type: none"> <li>• Scollegare l'apparecchio dalla presa di corrente prima di qualsiasi intervento.</li> <li>• Assicurarsi che la tensione di alimentazione del prodotto e le relative tolleranze sia compatibile con quelle della rete.</li> </ul> <p><b>La mancata osservanza di questa istruzioni comporta gravi rischi per la vita e l'incolumità personale.</b></p>	<p><b>RIESGO DE ELECTROCUCIÓN, EXPLOSIÓN O ARCO ELÉCTRICO</b></p> <ul style="list-style-type: none"> <li>• Desconecte toda alimentación antes de realizar el servicio.</li> <li>• Asegúrese de que la tensión de alimentación del producto y sus tolerancias son compatibles con las de la red eléctrica.</li> </ul> <p><b>Si no se respetan estas instrucciones, se producirán graves daños corporales o la muerte.</b></p>	<p>存在电击、爆炸或电弧危险</p> <ul style="list-style-type: none"> <li>• 维修设备前，请断开所有电源连接。</li> <li>• 确认产品电源电压及其公差兼容于网络的这些参数。</li> </ul> <p>若不遵守这些说明，可能会导致严重的人身伤害甚至死亡。</p>

- (en)** Electrical equipment should be installed, operated, serviced, and maintained only by qualified personnel. No responsibility is assumed by Schneider Electric for any consequences arising out of the use of this material.
- (fr)** Les équipements électriques doivent être installés, exploités et entretenus par un personnel qualifié. Schneider Electric décline toute responsabilité quant aux conséquences de l'utilisation de ce matériel.
- (de)** Elektrische Geräte dürfen nur von Fachpersonal installiert, betrieben, gewartet und instand gesetzt werden. Schneider Electric haftet nicht für Schäden, die aufgrund der Verwendung dieses Materials entstehen.
- (es)** Sólo el personal de servicio cualificado podrá instalar, utilizar, reparar y mantener el equipo eléctrico. Schneider Electric no asume las responsabilidades que pudieran surgir como consecuencia de la utilización de este material.
- (it)** Le apparecchiature elettriche devono essere installate, usate e riparate solo da personale qualificato. Schneider Electric non assume nessuna responsabilità per qualunque conseguenza derivante dall'uso di questo materiale.
- (zh)** 电器设备的安装、操作、维修和维护工作仅限于合格人员执行。对于超出本资料所引发的任何后果，Schneider Electric 概不负责。

**Schneider Electric Industries SAS**  
35, rue Joseph Monier  
CS 30323  
F - 92506 Rueil-Malmaison Cedex

施耐德电气生产工厂  
无锡普洛菲斯电子有限公司  
江苏省无锡国家高新技术产业开发区  
汉江路20号中国地区客服电话：  
+86 400 810 1315

**This product must be installed, connected and used in compliance with prevailing standards and/or installation regulations.**  
As standards, specifications and designs develop from time to time, always ask for confirmation of the information given in this publication.