

Varistors

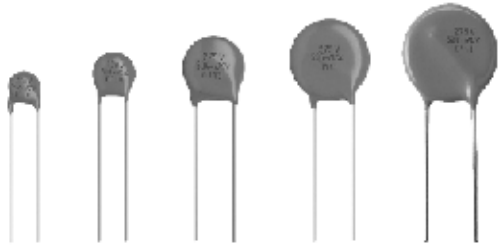

QUICK REFERENCE DATA		
PARAMETER	VALUE	UNIT
Maximum continuous voltage:		
RMS	14 to 680	V
DC	18 to 895	V
Maximum non-repetitive transient current I_{NRP} ($8 \times 20 \mu\text{s}$)	100 to 6500	A
Robustness of terminations	10	N
Drop test:		
Height of fall	1	m
Detailed specification	based on CECC 42000	
Storage temperature	- 40 to + 150	°C
Operating temperature	- 40 to + 125	°C

ORDERING INFORMATION

The varistors are available in a number of packing options:

- Bulk
- On tape on reel
- On tape in ammpack

The basic ordering code for each option is given in tables titled Varistors on Tape on Reel, Varistors on Tape in Ammpack and Varistors in Bulk. To complete the catalog number and to determine the required operating parameters, see Electrical Data and Ordering Information table.

FEATURES

- Zinc oxide disc, epoxy coated
- Straight leads
- Straight leads with flange (2381 592 and 593 series only)
- Kinked leads
- Component in accordance to RoHS 2002/95/EC and WEEE 2002/96/EC

APPLICATION

- Suppression of transients

DESCRIPTION

The varistors consist of a disc of low- β ceramic material with two tinned solid copper leads. They are coated with a layer of ochre coloured epoxy, which provides electrical, mechanical and climatic protection. The encapsulation is resistant to all cleaning solvents in accordance with "IEC 60068-2-45".

MOUNTING

The varistors are suitable for processing on automatic insertion and cutting and bending equipment.

Varistors with flanged leads provide better positioning on printed-circuit boards (PCB) and more accurate control over component height. This is important for hand mounting and automatic insertion techniques; see outlines of flanged leads drawing.

Typical Soldering

235 °C, duration: 5 s (Pb-bearing)

245 °C, duration: 5 s (Pb-free)

Resistance to soldering heat

260 °C, duration: 10 s max

MARKING

The varistors are marked with the following information:

- Maximum continuous RMS voltage
- Series number (592, 593, 594, 595 or 596)
- Manufacturers logo
- Date of manufacture

INFLAMMABILITY

The varistors are non-flammable.

The encapsulation is made of flammable resistant epoxy in accordance with UL94V-0.

ELECTRICAL DATA AND ORDERING INFORMATION

MAXIMUM CONTINUOUS VOLTAGE		VOLTAGE ³⁾ at 1 mA (V)	MAXIMUM VOLTAGE at STATED CURRENT		MAXIMUM ENERGY ⁴⁾ ($10 \times 1000 \mu\text{s}$) (J)	MAXIMUM NON-REP. TRANSIENT CURRENT ⁵⁾ I_{NRP} ($8 \times 20 \mu\text{s}$) (A)	TYPICAL CAPACITANCE at 1 kHz (pF)	CATALOG NUMBERS ¹⁾	
RMS ²⁾ (V)	DC (V)		V (V)	I (A)				12 NC ⁶⁾	SAP ⁷⁾
14	18	22	48	1.0	0.5	100	1300	2381 592 x140y	VDRS05A014xyE
			43	2.5	1.7	250	2800	2381 593 x140y	VDRS07B014xyE
			43	5.0	4.3	500	6000	2381 594 x140y	VDRS10D014xyE
			43	10.0	5.4	1000	15 000	2381 595 x140y	VDRS14G014xyE
			43	20.0	8.0	2000	30 000	2381 596 x140y	VDRS20M014ByE
17	22	27	60	1.0	0.7	100	1050	2381 592 x170y	VDRS05A017xyE
			53	2.5	2.0	250	2000	2381 593 x170y	VDRS07B017xyE
			53	5.0	5.3	500	4000	2381 594 x170y	VDRS10D017xyE
			53	10.0	6.9	1000	10 000	2381 595 x170y	VDRS14G017xyE
			53	20.0	10.0	2000	20 000	2381 596 x170y	VDRS20M017ByE



ELECTRICAL DATA AND ORDERING INFORMATION									
MAXIMUM CONTINUOUS VOLTAGE		VOLTAGE ³⁾ at 1 mA	MAXIMUM VOLTAGE at STATED CURRENT		MAXIMUM ENERGY ⁴⁾ (10 × 1000 µs)	MAXIMUM NON-REP. TRANSIENT CURRENT ⁵⁾ I _{NRP} (8 × 20 µs)	TYPICAL CAPACITANCE at 1 kHz	CATALOG NUMBERS ¹⁾	
RMS ²⁾ (V)	DC (V)	(V)	V (V)	I (A)	(J)	(A)	(pF)	12 NC ⁶⁾	SAP ⁷⁾
20	26	33	73	1.0	0.8	100	900	2381 592 x200y	VDRS05A020xyE
			65	2.5	2.5	250	1500	2381 593 x200y	VDRS07B020xyE
			65	5.0	6.5	500	3000	2381 594 x200y	VDRS10D020xyE
			65	10.0	8.8	1000	7500	2381 595 x200y	VDRS14G020xyE
			65	20.0	12.0	2000	15 000	2381 596 x200y	VDRS20M020ByE
25	31	39	86	1.0	0.9	100	500	2381 592 x250y	VDRS05A025xyE
			77	2.5	3.0	250	1350	2381 593 x250y	VDRS07B025xyE
			77	5.0	7.7	500	2600	2381 594 x250y	VDRS10D025xyE
			77	10.0	9.4	1000	6500	2381 595 x250y	VDRS14G025xyE
30	38	47	96	1.0	1.1	100	700	2381 592 x300y	VDRS05A030xyE
			93	2.5	3.6	250	1600	2381 593 x300y	VDRS07B030xyE
			93	5.0	9.2	500	2700	2381 594 x300y	VDRS10D030xyE
			90	10.0	12.0	1000	6000	2381 595 x300y	VDRS14G030xyE
35	45	56	93	20.0	17.0	2000	12 000	2381 596 x300y	VDRS20M030ByE
			123	1.0	1.4	100	560	2381 592 x350y	VDRS05A035xyE
			115	2.5	4.4	250	1300	2381 593 x350y	VDRS07B035xyE
			110	5.0	11.0	500	2200	2381 594 x350y	VDRS10D035xyE
			105	10.0	14.0	1000	4800	2381 595 x350y	VDRS14G035xyE
40	56	68	110	20.0	20.0	2000	9600	2381 596 x350y	VDRS20M035ByE
			145	1.0	1.6	100	460	2381 592 x400y	VDRS05A040xyE
			135	2.5	5.2	250	1000	2381 593 x400y	VDRS07B040xyE
			130	5.0	13.0	500	1800	2381 594 x400y	VDRS10D040xyE
50	65	82	130	10.0	17.0	1000	3800	2381 595 x400y	VDRS14G040xyE
			135	20.0	24.0	2000	7600	2381 596 x400y	VDRS20M040ByE
			145	5.0	2.6	400	370	2381 592 x500y	VDRS05C050xyE
			140	10.0	7.0	1200	900	2381 593 x500y	VDRS07H050xyE
			140	25.0	12.0	2500	1500	2381 594 x500y	VDRS10P050xyE
60	85	100	140	50.0	21.0	4500	3100	2381 595 x500y	VDRS14T050xyE
			135	100.0	44.0	6500	6200	2381 596 x500y	VDRS20W050ByE
			165	5.0	2.9	400	290	2381 592 x600y	VDRS05C060TSE
			165	10.0	8.3	1200	700	2381 593 x600y	VDRS07H060TSE
			165	25.0	15.0	2500	1200	2381 594 x600y	VDRS10P060TSE
75	100	120	165	50.0	24.0	4500	2300	2381 595 x600y	VDRS14T060TSE
			165	100.0	56.0	6500	4700	2381 596 x600y	VDRS20W060BSE
			190	5.0	3.4	400	240	2381 592 x750y	VDRS05C075xyE
			200	10.0	10.0	1200	530	2381 593 x750y	VDRS07H075xyE
			200	25.0	18.0	2500	1000	2381 594 x750y	VDRS10P075xyE
95	125	150	200	50.0	29.0	4500	1900	2381 595 x750y	VDRS14T075xyE
			200	100.0	64.0	6500	3900	2381 596 x750y	VDRS20W075ByE
			230	5.0	4.1	400	180	2381 592 x950y	VDRS05C095xyE
			250	10.0	13.0	1200	450	2381 593 x950y	VDRS07H095xyE
			250	25.0	22.0	2500	800	2381 594 x950y	VDRS10P095xyE
130	170	205	250	50.0	37.0	4500	1500	2381 595 x950y	VDRS14T095xyE
			250	100.0	88.0	6500	3000	2381 596 x950y	VDRS20W095ByE
			310	5.0	5.5	400	130	2381 592 x131y	VDRS05C130xyE
			340	10.0	17.0	1200	320	2381 593 x131y	VDRS07H130xyE
			340	25.0	30.0	2500	580	2381 594 x131y	VDRS10P130xyE
130	170	205	340	50.0	56.0	4500	1050	2381 595 x131y	VDRS14T130xyE
			340	100.0	114.0	6500	2100	2381 596 x131y	VDRS20W130ByE

ELECTRICAL DATA AND ORDERING INFORMATION									
MAXIMUM CONTINUOUS VOLTAGE		VOLTAGE ³⁾ at 1 mA	MAXIMUM VOLTAGE at STATED CURRENT		MAXIMUM ENERGY ⁴⁾ (10 × 1000 μs)	MAXIMUM NON-REP. TRANSIENT CURRENT ⁵⁾ I _{NRP} (8 × 20 μs)	TYPICAL CAPACITANCE at 1 kHz	CATALOG NUMBERS ¹⁾	
RMS ²⁾ (V)	DC (V)	(V)	V (V)	I (A)	(J)	(A)	(pF)	12 NC ⁶⁾	SAP ⁷⁾
140	180	220	350	5.0	6.3	400	120	2381 592 x141y	VDRS05C140xyE
			370	10.0	21.0	1200	290	2381 593 x141y	VDRS07H140xyE
			370	25.0	33.0	2500	540	2381 594 x141y	VDRS10P140xyE
			370	50.0	57.0	4500	950	2381 595 x141y	VDRS14T140xyE
			360	100.0	124.0	6500	1900	2381 596 x141y	VDRS20W140ByE
150	200	240	395	5.0	7.1	400	110	2381 592 x151y	VDRS05C150xyE
			400	10.0	20.0	1200	270	2381 593 x151y	VDRS07H150xyE
			400	25.0	36.0	2500	490	2381 594 x151y	VDRS10P150xyE
			400	50.0	59.0	4500	850	2381 595 x151y	VDRS14T150xyE
			395	100.0	134.0	6500	1700	2381 596 x151y	VDRS20W150ByE
175	225	275	410	5.0	7.3	400	90	2381 592 x171y	VDRS05C175xyE
			455	10.0	23.0	1200	230	2381 593 x171y	VDRS07H175xyE
			455	25.0	41.0	2500	430	2381 594 x171y	VDRS10P175xyE
			455	50.0	67.0	4500	750	2381 595 x171y	VDRS14T175xyE
			455	100.0	158.0	6500	1500	2381 596 x171y	VDRS20W175ByE
230	300	360	560	5.0	10.0	400	70	2381 592 x231y	VDRS05C230xyE
			600	10.0	30.0	1200	170	2381 593 x231y	VDRS07H230xyE
			600	25.0	54.0	2500	320	2381 594 x231y	VDRS10P230xyE
			600	50.0	88.0	4500	540	2381 595 x231y	VDRS14T230xyE
			595	100.0	208.0	6500	1100	2381 596 x231y	VDRS20W230ByE
250	320	390	600	5.0	11.0	400	60	2381 592 x251y	VDRS05C250xyE
			650	10.0	33.0	1200	160	2381 593 x251y	VDRS07H250xyE
			650	25.0	58.0	2500	300	2381 594 x251y	VDRS10P250xyE
			650	50.0	96.0	4500	480	2381 595 x251y	VDRS14T250xyE
			650	100.0	240.0	6500	960	2381 596 x251y	VDRS20W250ByE
275	350	430	695	5.0	12.0	400	55	2381 592 x271y	VDRS05C275xyE
			710	10.0	36.0	1200	140	2381 593 x271y	VDRS07H275xyE
			710	25.0	63.0	2500	270	2381 594 x271y	VDRS10P275xyE
			710	50.0	104.0	4500	440	2381 595 x271y	VDRS14T275xyE
			710	100.0	264.0	6500	900	2381 596 x271y	VDRS20W275ByE
300	385	470	750	5.0	13.0	400	50	2381 592 x301y	VDRS05C300xyE
			800	10.0	40.0	1200	130	2381 593 x301y	VDRS07H300xyE
			800	25.0	71.0	2500	240	2381 594 x301y	VDRS10P300xyE
			800	50.0	117.0	4500	400	2381 595 x301y	VDRS14T300xyE
			775	100.0	280.0	6500	810	2381 596 x301y	VDRS20W300ByE
320	420	510	800	5.0	15.0	400	45	2381 592 x321y	VDRS05C320xyE
			850	10.0	44.0	1200	120	2381 593 x321y	VDRS07H320xyE
			850	25.0	77.0	2500	220	2381 594 x321y	VDRS10P320xyE
			850	50.0	120.0	4500	370	2381 595 x321y	VDRS14T320xyE
			842	100.0	296.0	6500	750	2381 596 x321y	VDRS20W320ByE
350	460	560	940	5.0	19.5	400	42	2381 592 x351y	VDRS05C350xyE
			920	10.0	39.0	1200	110	2381 593 x351y	VDRS07H350xyE
			920	25.0	78.0	2500	200	2381 594 x351y	VDRS10P350xyE
			920	50.0	156.0	4500	325	2381 595 x351y	VDRS14T350xyE
			920	100.0	312.0	6500	660	2381 596 x351y	VDRS20W350ByE



ELECTRICAL DATA AND ORDERING INFORMATION									
MAXIMUM CONTINUOUS VOLTAGE		VOLTAGE ³⁾ at 1 mA (V)	MAXIMUM VOLTAGE at STATED CURRENT		MAXIMUM ENERGY ⁴⁾ (10 × 1000 μs) (J)	MAXIMUM NON-REP. TRANSIENT CURRENT ⁵⁾ I _{NRP} (8 × 20 μs) (A)	TYPICAL CAPACITANCE at 1 kHz (pF)	CATALOG NUMBERS ¹⁾	
RMS ²⁾ (V)	DC (V)		V (V)	I (A)				12 NC ⁶⁾	SAP ⁷⁾
385	505	620	1000	5.0	18.0	400	40	2381 592 x381y	VDRS05C385xyE
			1025	10.0	51.0	1200	95	2381 593 x381y	VDRS07H385xyE
			1025	25.0	67.0	2500	180	2381 594 x381y	VDRS10P385xyE
			1025	50.0	110.0	4500	280	2381 595 x381y	VDRS14T385xyE
			1025	100.0	328.0	6500	570	2381 596 x381y	VDRS20W385ByE
420	560	680	1100	5.0	20.0	400	35	2381 592 x421y	VDRS05C420xyE
			1120	10.0	56.0	1200	85	2381 593 x421y	VDRS07H420xyE
			1120	25.0	73.0	2500	165	2381 594 x421y	VDRS10P420xyE
			1120	50.0	120.0	4500	250	2381 595 x421y	VDRS14T420xyE
			1120	100.0	344.0	6500	510	2381 596 x421y	VDRS20W420ByE
460	615	750	1200	5.0	21.0	400	30	2381 592 x461y	VDRS05C460xyE
			1240	10.0	63.0	1200	75	2381 593 x461y	VDRS07H460xyE
			1240	25.0	82.0	2500	150	2381 594 x461y	VDRS10P460xyE
			1240	50.0	135.0	4500	225	2381 595 x461y	VDRS14T460xyE
			1240	100.0	360.0	6500	460	2381 596 x461y	VDRS20W460ByE
510	670	820	1355	25.0	89.0	2500	135	2381 594 x511y	VDRS10P510xyE
			1355	50.0	145.0	4500	220	2381 595 x511y	VDRS14T510xyE
			1355	100.0	376.0	6500	450	2381 596 x511y	VDRS20W510ByE
550	745	910	1500	25.0	98.0	2500	120	2381 594 x551y	VDRS10P550xyE
			1500	50.0	160.0	4500	180	2381 595 x551y	VDRS14T550xyE
			1500	100.0	408.0	6500	370	2381 596 x551y	VDRS20W550ByE
625	825	1000	1650	100.0	448.0	6500	320	2381 596 x621y	VDRS20W625ByE
680	895	1100	1815	100.0	496.0	6500	270	2381 596 x681y	VDRS20W680ByE

Notes

- Lists with products certified according to UL (E98144), VDE (40002622) and CSA (219883) are available at www.vishay.com or on request.
- The sinusoidal voltage is assumed as the normal operating condition. If a non-sinusoidal voltage is present, type selection should be based on multiplying the peak voltage by a factor of 0.707.
- The voltage measured at 1 mA meets the requirements of "paragraph 4.3 of CECC specification 42000".
The tolerance on the voltage at 1 mA is ± 10 %.
- High energy surges are generally of longer duration. The maximum energy for one pulse of 10 × 1000 μs is given as a reference for longer duration pulses. This pulse can be characterised by peak current (I_p) and pulse width t₂ (virtual time of half I_p value, following "IEC 60060-2, section 6"). If V_p is the clamping voltage corresponding to I_p, the energy absorbed in the varistor is determined by the formula:
E = K × V_p × I_p × t₂
where:
a) K is dependent on the value of t₂ when the value of t₁ is between 8 μs and 10 μs; see Peak Current as a Function of Pulse Width drawing.
- A current wave of 8 × 20 μs (requirement of "paragraph B.2.10.1 of CECC specification 42000") is used as a standard for pulse current and clamping voltage ratings. The maximum non-repetitive transient current is given for one pulse applied during the life of the component.
- For composition of the 12NC part number replace "x" and "y" by figures from the sections "Varistors in Bulk", "Varistors on Tape in Ammpack" and "Varistors on Tape on Reel".
- For composition of the SAP part number:
Replace "x" by B for bulk type
T for tape and reel
A for tape and ammpack
Replace "y" by S for straight leads
F for straight leads with flange
G for straight leads with flange and H₀ = 16 mm
H for straight leads with flange and H₀ = 18.25 mm
K for kinked leads
L for kinked leads with H₀ = 16 mm
M for kinked leads with H₀ = 18.25 mm

ELECTRICAL CHARACTERISTICS

ELECTRICAL DATA		
PARAMETER	VALUE	UNIT
Maximum continuous voltage:		
RMS	14 to 680	V
DC	18 to 895	V
Maximum non-repetitive transient current (I_{nrp}) ($8 \times 20 \mu s$):		
2381 592 / VDRS05.....E	100 or 400	A
2381 593 / VDRS07.....E	250 or 1200	A
2381 594 / VDRS10.....E	500 or 2500	A
2381 595 / VDRS14.....E	1000 or 4500	A
2381 596 / VDRS20.....E	2000 or 6500	A
Thermal resistance:		
2381 592 / VDRS05.....E	≈ 80	K/W
2381 593 / VDRS07.....E	≈ 70	K/W
2381 594 / VDRS10.....E	≈ 60	K/W
2381 595 / VDRS14.....E	≈ 50	K/W
2381 596 / VDRS20.....E	≈ 40	K/W
Maximum dissipation:		
2381 592 / VDRS05.....E	100	mW
2381 593 / VDRS07.....E	250	mW
2381 594 / VDRS10.....E	400	mW
2381 595 / VDRS14.....E	600	mW
2381 596 / VDRS20.....E	1000	mW
Temperature coefficient of voltage at 1 mA maximum	- 0.065	%/K
Voltage proof between interconnected leads and case	2500	V
Storage temperature	- 40 to + 150	°C
Operating temperature	- 40 to + 125	°C

DERATING CURVE

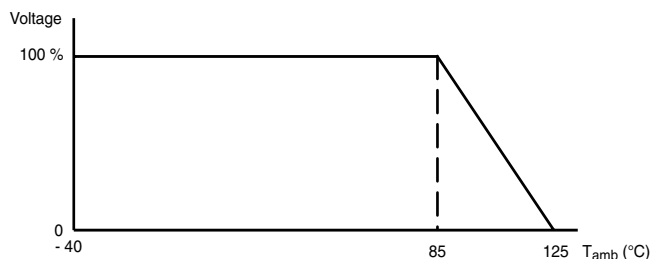

PEAK CURRENT AS A FUNCTION OF PULSE WIDTH

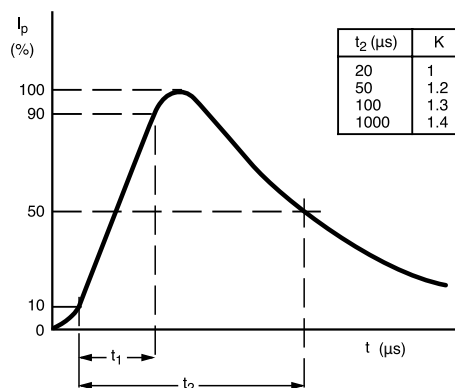

COMPONENT DIMENSIONS AND CATALOG NUMBERS in millimeters									
D NOM.	D MAX.	A MAX.	A ₀ MAX.	L MIN.	T MAX.	T MIN.	∅ D	F	CATALOG NUMBER
5.0	7.0	9.0	11.0	27.0	6	4.1	0.6 ± 0.05	5 + 0.6/- 0.1	2381 592 / VDRS05.....E
7.0	9.0	11.0	13.0	27.0	6	4.1	0.6 ± 0.05	5 + 0.6/- 0.1	2381 593 / VDRS07.....E
10.0	13.5	15.5	18.0	17.0	7	4.4	0.8 ± 0.05	7.5 ± 0.8	2381 594 / VDRS10.....E
14.0	17.0	19.0	23.0	16.0	7	4.4	0.8 ± 0.05	7.5 ± 0.8	2381 595 / VDRS14.....E
20.0	23.0	25.0	28.0	24.0	7	5.0	1.0 ± 0.05	10 ± 0.8	2381 596 / VDRS20.....E

VARISTORS IN BULK					
TYPE	2381 592 Ø 5 mm 14 V to 460 V	2381 593 Ø 7 mm 14 V to 460 V	2381 594 Ø 10 mm 14 V to 550 V	2381 595 Ø 14 mm 14 V to 550 V	2381 596 Ø 20 mm 14 V to 680 V
Straight leads; see Outline of components with straight leads drawing ¹⁾	5...6	5...6	5...6	5...6	5...6
Straight leads with flange; see Outline of components with flanged leads drawing	7...6	7...6	–	–	–
Kinked leads; see Outline of components with kinked leads drawing	6...6	6...6	6...6	6...6	6...6
Packing quantities					
14 V to 95 V	250	250	250	100	50
130 V to 460 V	250	250	250	100	50
485 V to max. V	-	250	150	100	50

Note

1. Outline of the Ø 20 mm differs from the other dimensions.

DIMENSIONS in millimeters

Outline of component with straight leads

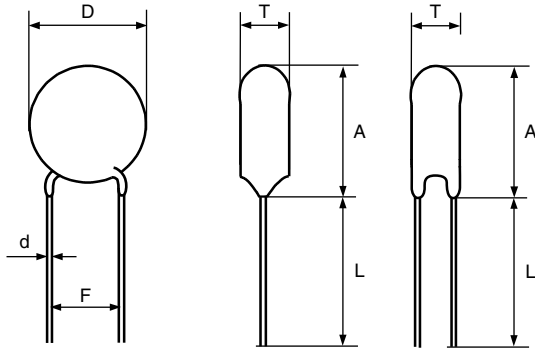

For dimensions, see Component Dimensions and Catalog Numbers table

Outline of component with flanged leads

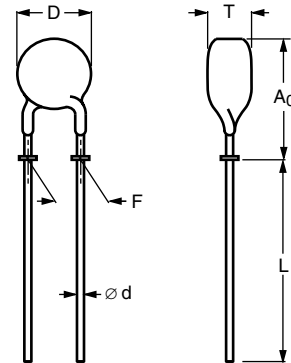

For dimensions, see Component Dimensions and Catalog Numbers table

Outline of component with kinked leads

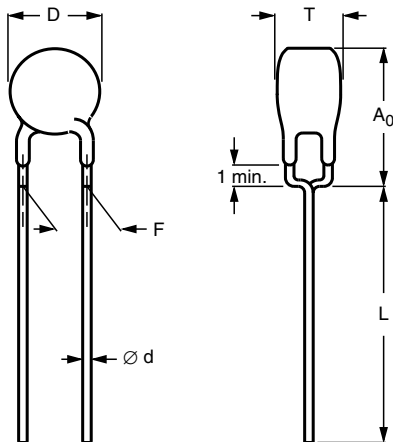

For dimensions, see Component Dimensions and Catalog Numbers table

Outline of flanged leads

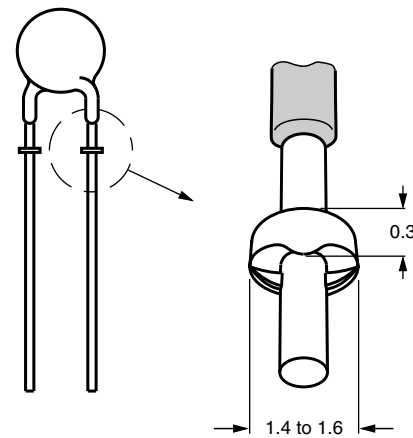

VARISTORS ON TAPE IN AMMOPACK				
TYPE	2381 592 ∅ 5 mm 14 V to 460 V	2381 593 ∅ 7 mm 14 V to 460 V	2381 594 ∅ 10 mm 14 V to 550 V	2381 595 ∅ 14 mm 14V to 550 V
Straight leads H = 18 mm H = 20 mm See drawing Taped version with straight leads	- 0...7	- 0...7	0...7 -	0...7 -
Straight leads with flange H ₀ = 16 mm H ₀ = 18.25 mm See drawing Taped version with flanged leads	1...7 2...7	1...7 2...7	- -	- -
Kinked leads H ₀ = 18.25 mm H ₀ = 16 mm See drawing Taped version with kinked leads	3...7 8...7	3...7 8...7	3...7 8...7	3...7 8...7
Packing quantities				
14 V to 210 V	1500 ¹⁾	1500 ¹⁾	500	500
230 V to max. V	1000	1000	500	500

Note

1. Except for 35 and 40 V = 1000 pieces

DIMENSIONS OF AMMOPACK in millimeters

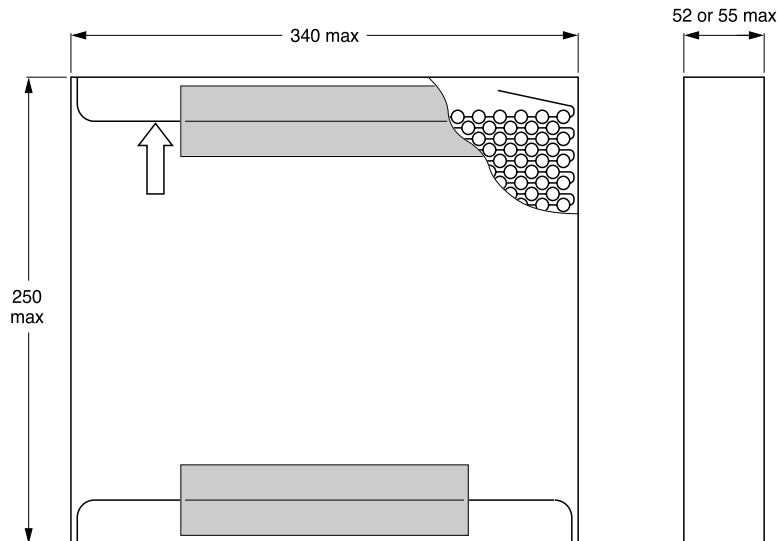

VARISTORS ON TAPE ON REEL				
TYPE	2381 592 Ø 5 mm 14 V to 460 V	2381 593 Ø 7 mm 14 V to 460 V	2381 594 Ø 10 mm 14 V to 550 V	2381 595 Ø 14 mm 14 V to 550 V
Straight leads H = 18 mm H = 20 mm See drawing Taped version with straight leads	- 0...6	- 0...6	0...6 -	0...6 -
Straight leads with flange H ₀ = 16 mm H ₀ = 18.25 mm See drawing Taped version with flanged leads	1...6 2...6	1...6 2...6	- -	- -
Kinked leads H ₀ = 18.25 mm H ₀ = 16 mm See drawing Taped version with kinked leads	3...6 8...6	3...6 8...6	3...6 8...6	3...6 8...6
Packing quantities				
14 V to 250 V	1500	1500	1000	750
275 V to 300 V	1500	1500	750	750
320 V to 350 V	1500	1500	500	500
385 V to max. V	1500	1000	500	500

PACKING

TAPED VERSION WITH STRAIGHT LEADS (only for 2381 592 / VDRS05.....E and 2381 593 / VDRS07.....E)

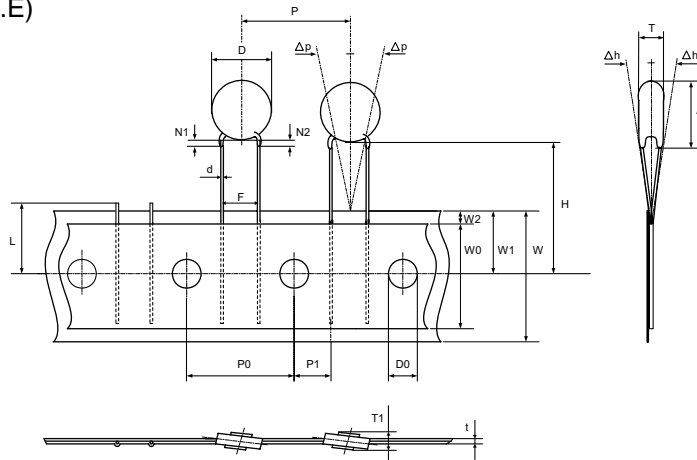

TAPED VERSION WITH STRAIGHT LEADS (only for 2381 594 / VDRS10.....E and 2381 595 / VDRS14.....E)

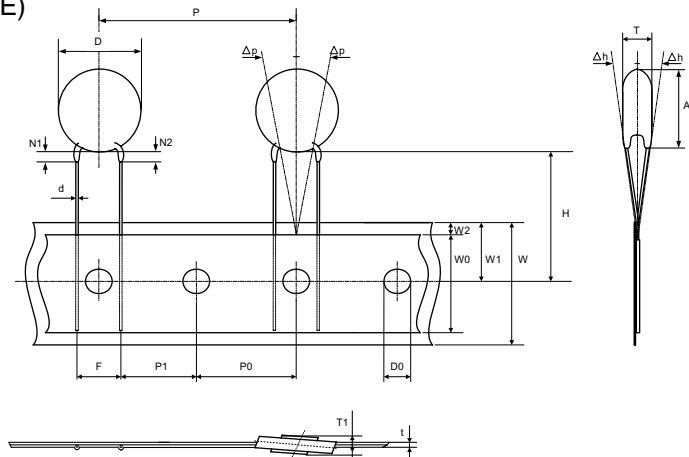

TAPED VERSION WITH KINKED LEADS

(only for 2381 592 / VDRS05.....E and 2381 593 / VDRS07.....E)

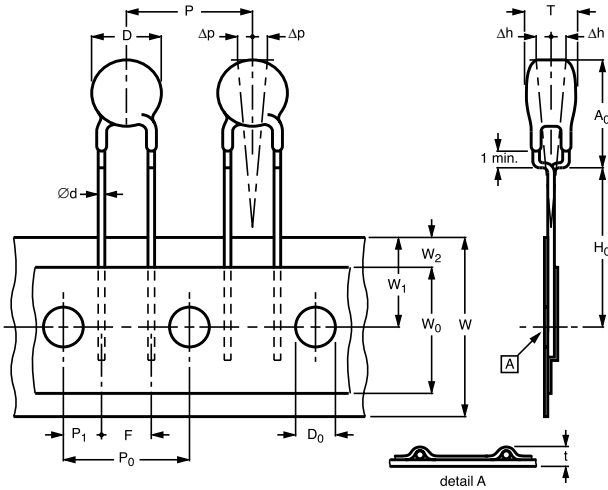

For dimensions, see Taping data table

TAPED VERSION WITH KINKED LEADS

(only for 2381 594 / VDRS10.....E and 2381 595 / VDRS14.....E)

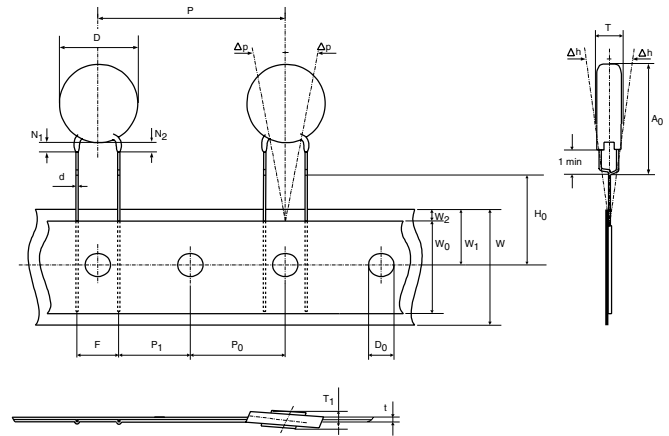

For dimensions, see Taping data table

TAPED VERSION WITH FLANGED LEADS

(only for 2381 592 / VDRS05.....E and 2381 593 / VDRS07.....E)

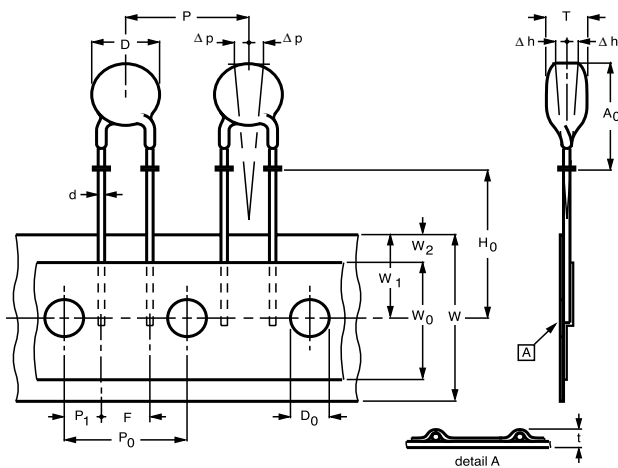

For dimensions, see Taping data table

DIMENSIONS OF REELS in millimeters

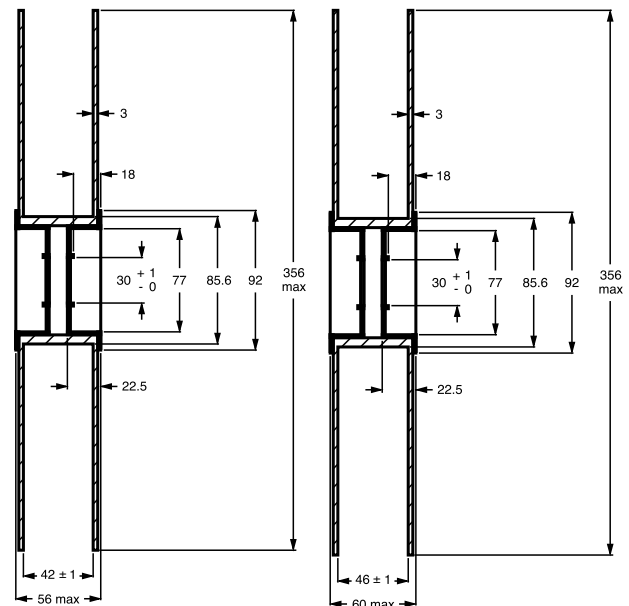

For 2381 592 / VDRS05.....E and 2381 593 / VDRS07.....E

For 2381 594 / VDRS10.....E and 2381 595 / VDRS14.....E



TAPING DATA (based on "IEC 60286-2")				
SYMBOL	PARAMETER	DIMENSIONS NOMINAL (MM)	TOLERANCE (MM)	REMARKS
D	body diameter	see Component Dimensions table		
T	total thickness	see Component Dimensions table		
A ₀ ; A	mounting height	see Component Dimensions table		
∅ d	lead diameter	see Component Dimensions table		
F	lead to lead distance	see Component Dimensions table		guaranteed between component and tape
P	component pitch	12.7 or 25.4	± 1.0	
P ₀	feed hole pitch	12.7	± 0.3	cumulative pitch error ± 1 mm/20 pitches
P ₁	feed hole centre to lead centre	3.85 or 8.95	± 0.7	guaranteed between component and tape
Δp	component alignment	0.0	± 1.3	
Δh	component alignment	0.0	± 2.0	
W	tape width	18.0	+ 1.0/- 0.5	
W ₀	hold down tape width	≥ 12.5		
W ₁	hole position	9.0	± 0.5	
W ₂	hold down tape position	≤ 3.0		
H	height between component and tape centre	18.0	+ 2.0/- 0.0	straight lead version 2381 594 and 2381 595
		20.0	+ 2.0/- 0.0	straight lead version 2381 592 and 2381 593
H ₀	lead-wire flange height	16.0 or 18.25	± 0.5	flanged and kinked lead versions
D ₀	feed hole diameter	4.0	± 0.2	
t	total tape thickness	≤ 1.4		with cardboard tape 0.5 ± 0.1 mm

V/I CHARACTERISTICS, 14 V TO 40 V (RMS); 2381 592 / VDRS05.....E

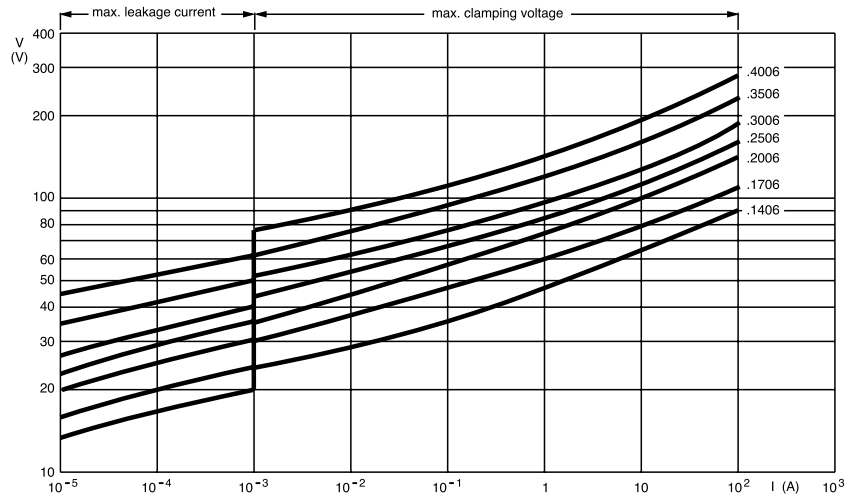

V/I CHARACTERISTICS, 50 V TO 460 V (RMS); 2381 592 / VDRS05.....E

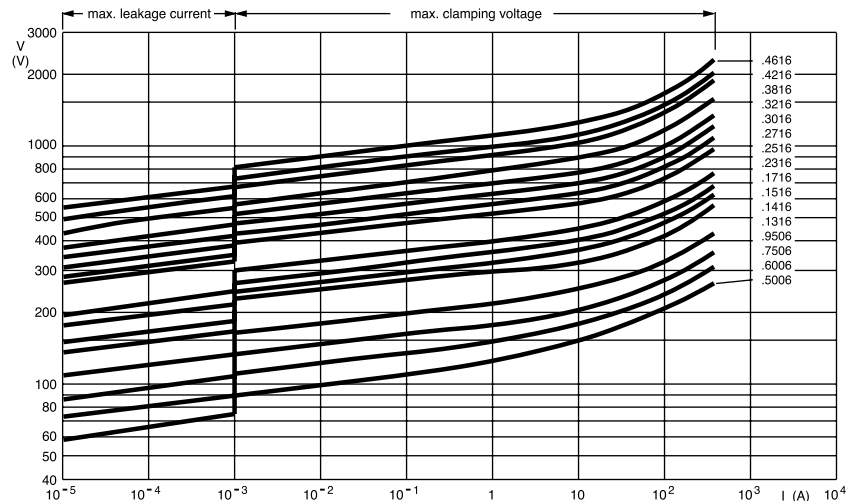

V/I CHARACTERISTICS, 14 V TO 40 V (RMS); 2381 593 / VDRS07.....E

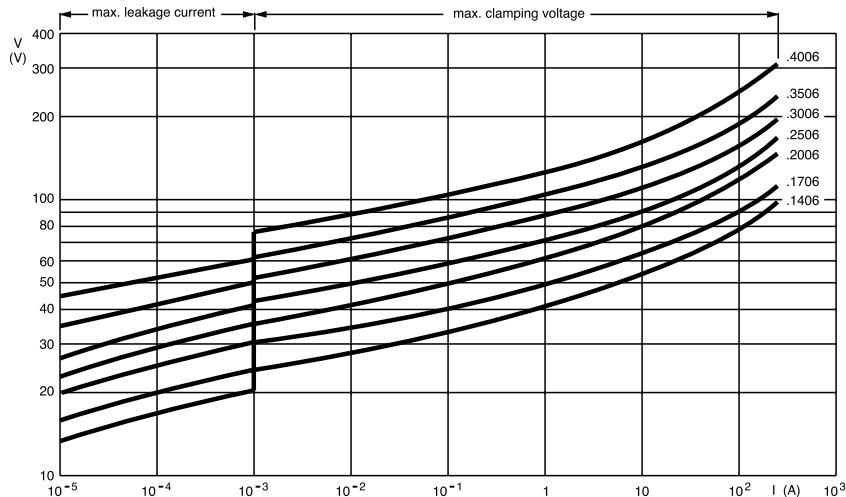



V/I CHARACTERISTICS, 50 V TO 460 V (RMS); 2381 593 / VDRS07.....E

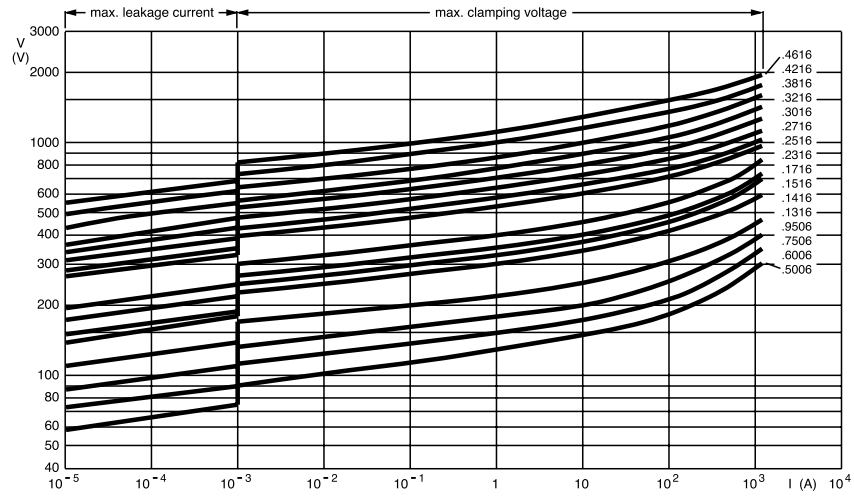

V/I CHARACTERISTICS, 14 V TO 40 V (RMS); 2381 594 / VDRS10.....E

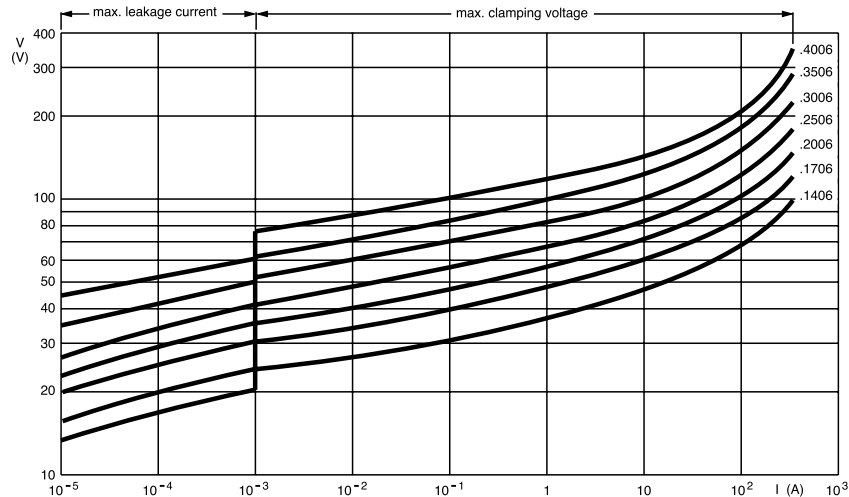

V/I CHARACTERISTICS, 50 V TO 550 V (RMS); 2381 594 / VDRS10.....E

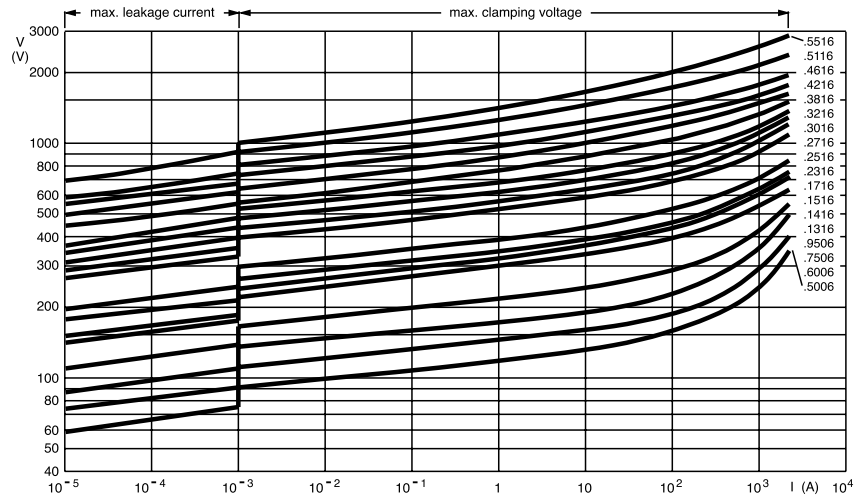

V/I CHARACTERISTICS, 14 V TO 40 V (RMS); 2381 595 / VDRS14.....E

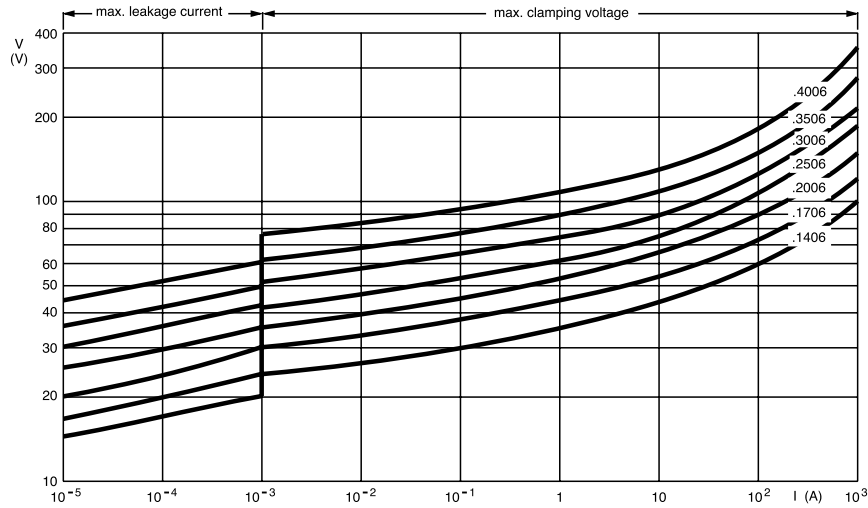

V/I CHARACTERISTICS, 50 V TO 550 V (RMS); 2381 595 / VDRS14.....E

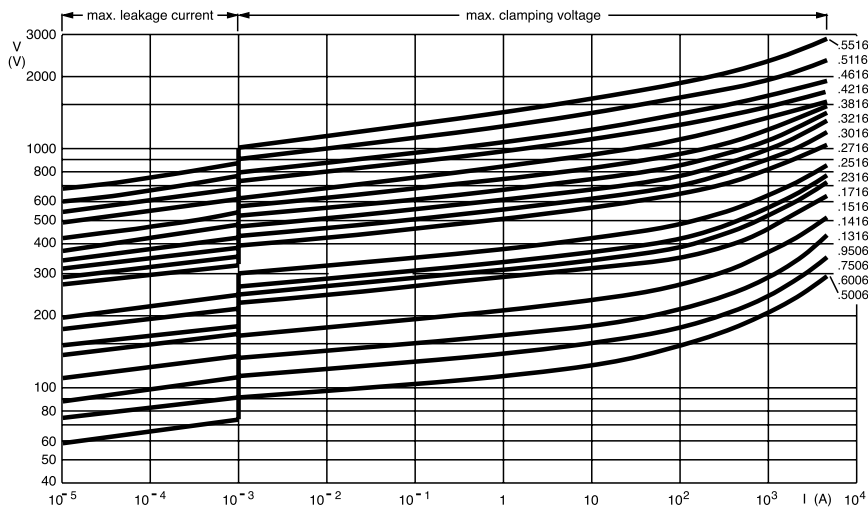

V/I CHARACTERISTICS, 14 V TO 40 V (RMS); 2381 596 / VDRS20.....E

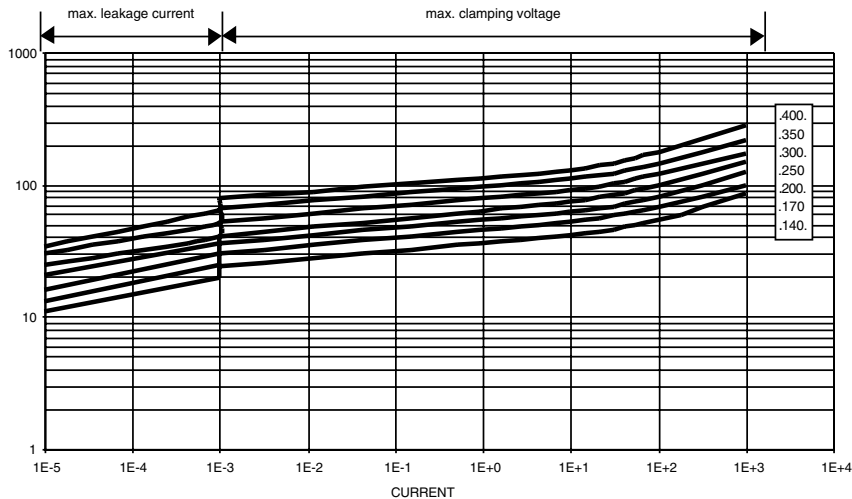



V/I CHARACTERISTICS, 50 V TO 680 V (RMS); 2381 596 / VDRS20.....E

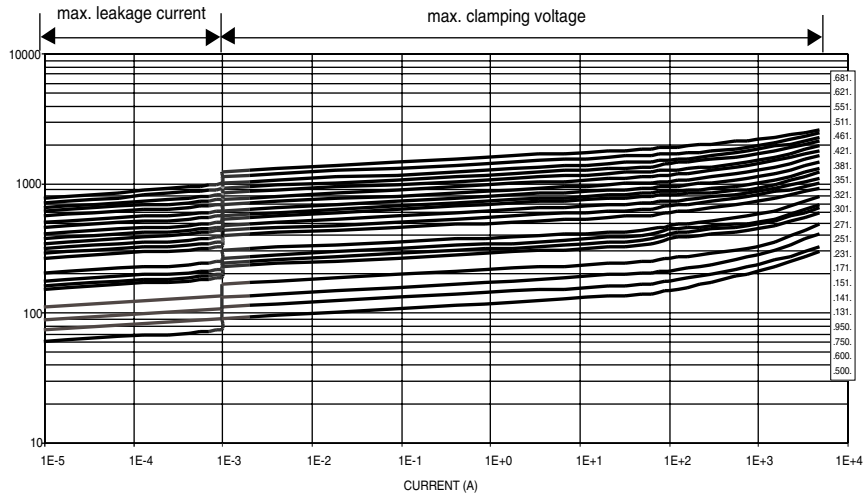

MAXIMUM APPLICABLE TRANSIENT CURRENT AS A FUNCTION OF PULSE DURATION, 14 V TO 40 V (RMS); 2381 592 / VDRS05.....E

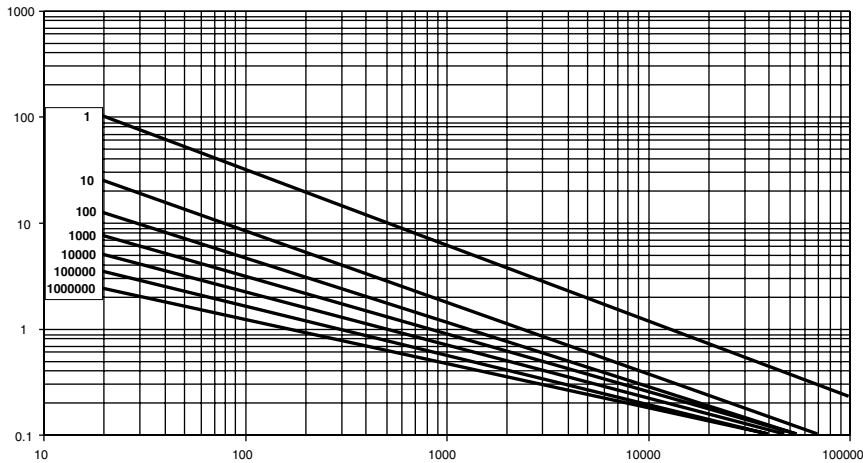

MAXIMUM APPLICABLE TRANSIENT CURRENT AS A FUNCTION OF PULSE DURATION, 50 V TO 460 V (RMS); 2381 592 / VDRS05.....E

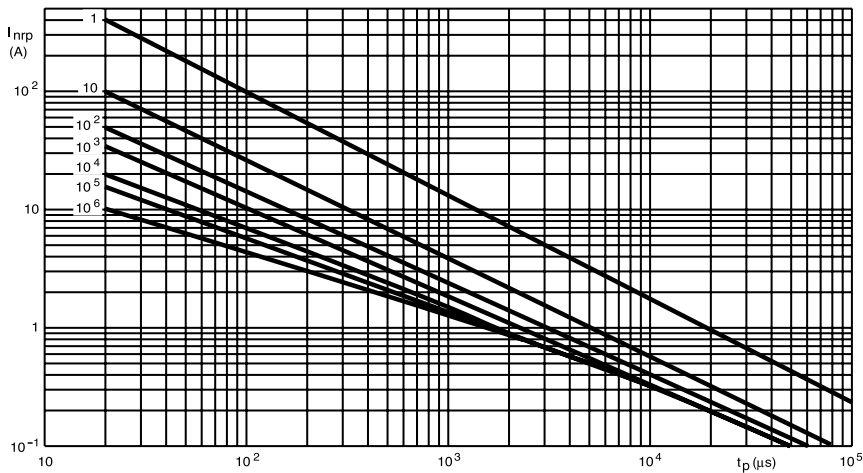



**MAXIMUM APPLICABLE TRANSIENT CURRENT AS A FUNCTION OF PULSE DURATION,
14 V TO 40 V (RMS); 2381 593 / VDRS07.....E**

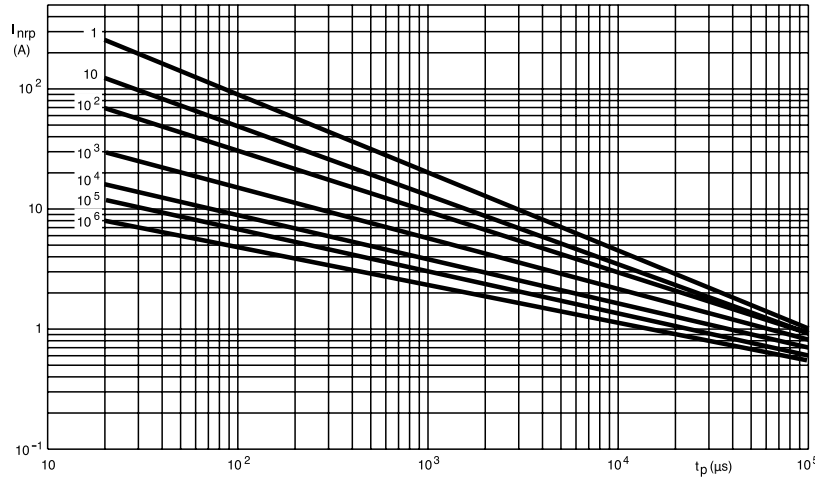

**MAXIMUM APPLICABLE TRANSIENT CURRENT AS A FUNCTION OF PULSE DURATION,
50 V TO 460 V (RMS); 2381 593 / VDRS07.....E**

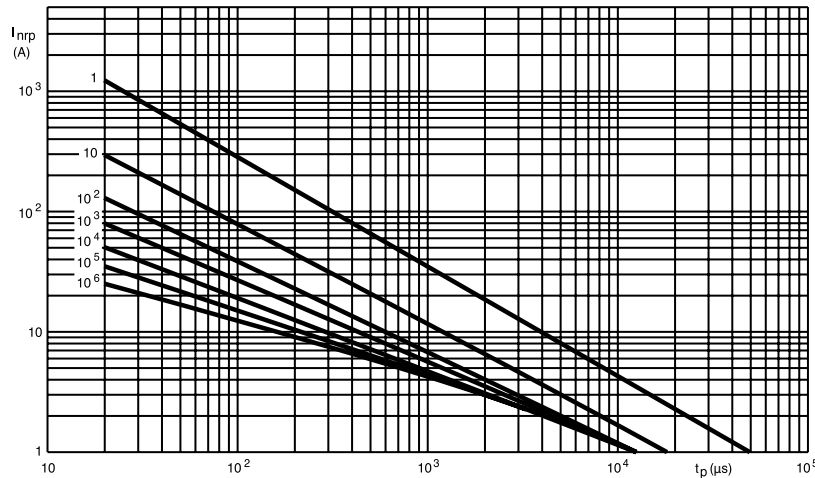

**MAXIMUM APPLICABLE TRANSIENT CURRENT AS A FUNCTION OF PULSE DURATION,
14 V TO 40 V (RMS); 2381 594 / VDRS10.....E**

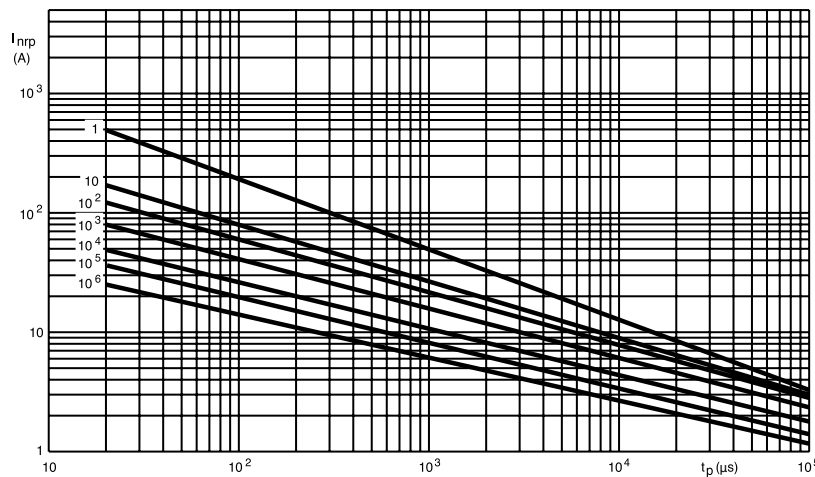



MAXIMUM APPLICABLE TRANSIENT CURRENT AS A FUNCTION OF PULSE DURATION, 50 V TO 320 V (RMS); 2381 594 / VDRS10.....E

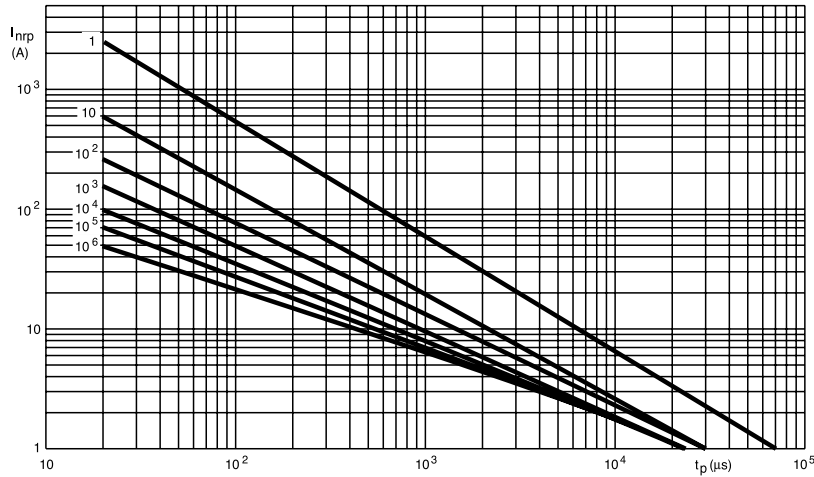

MAXIMUM APPLICABLE TRANSIENT CURRENT AS A FUNCTION OF PULSE DURATION, 385 V TO 550 V (RMS); 2381 594 / VDRS10.....E

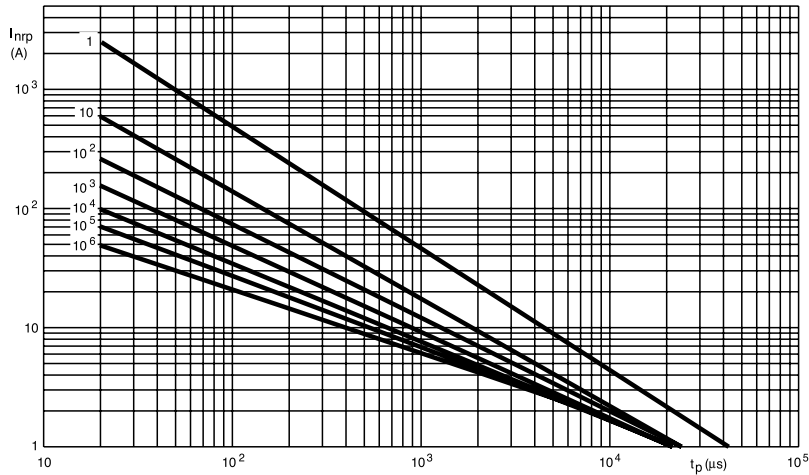

MAXIMUM APPLICABLE TRANSIENT CURRENT AS A FUNCTION OF PULSE DURATION, 14 V TO 40 V (RMS); 2381 595 / VDRS14.....E

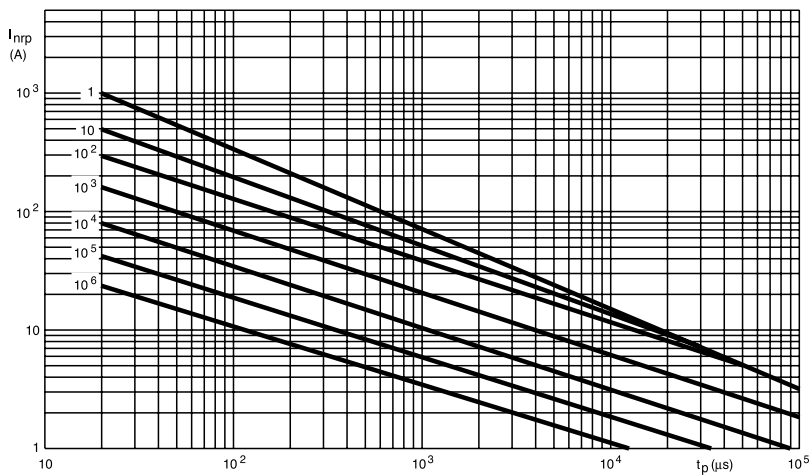



MAXIMUM APPLICABLE TRANSIENT CURRENT AS A FUNCTION OF PULSE DURATION, 50 V TO 320 V (RMS); 2381 595 / VDRS14.....E

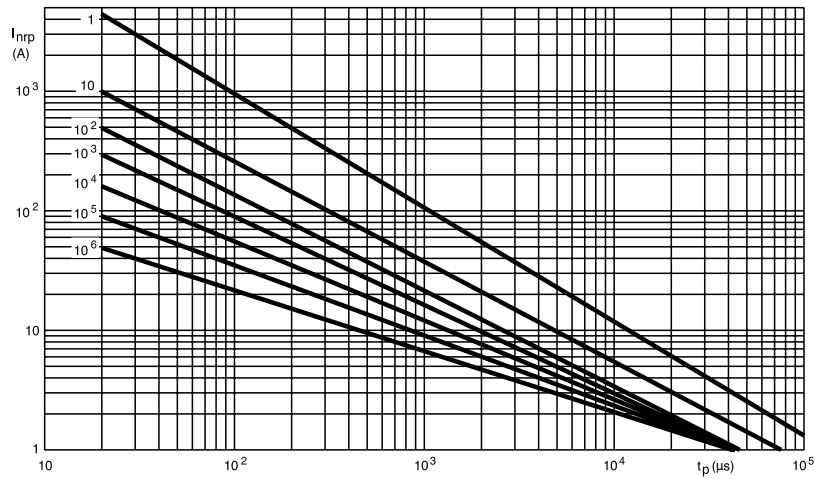

MAXIMUM APPLICABLE TRANSIENT CURRENT AS A FUNCTION OF PULSE DURATION, 385 V TO 550 V (RMS); 2381 595 / VDRS14.....E

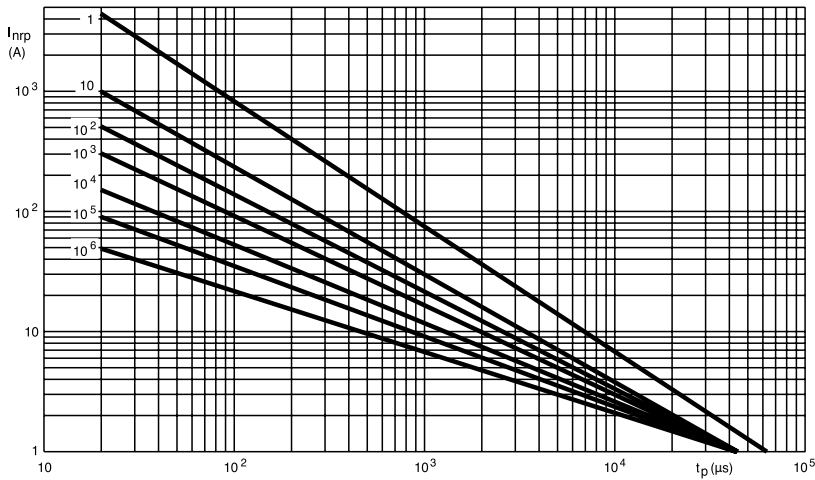

MAXIMUM APPLICABLE TRANSIENT CURRENT AS A FUNCTION OF PULSE DURATION, 14 V TO 40 V (RMS); 2381 596 / VDRS20.....E

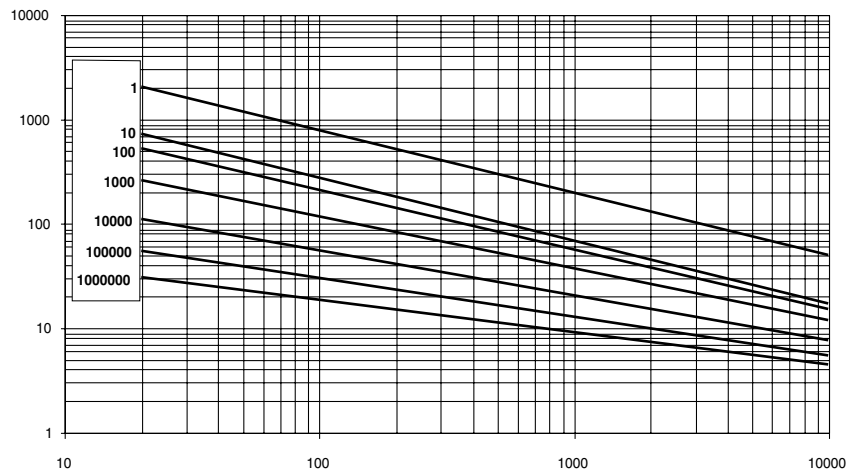



**MAXIMUM APPLICABLE TRANSIENT CURRENT AS A FUNCTION OF PULSE DURATION,
60 V TO 300 V (RMS); 2381 596 / VDRS20.....E**

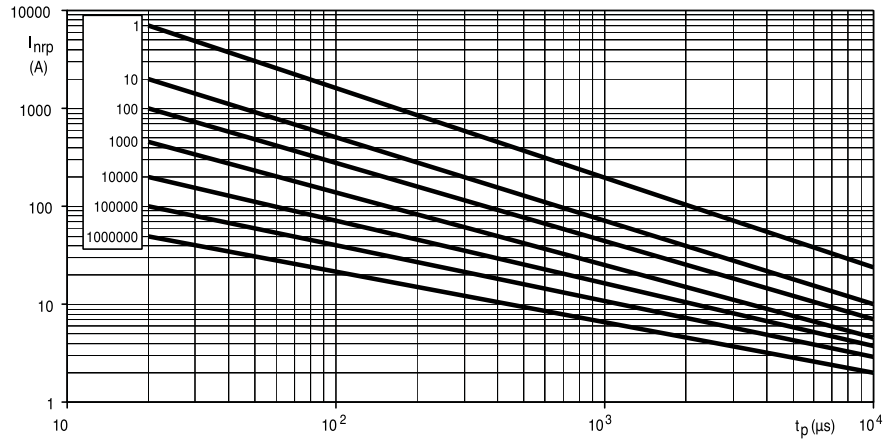

**MAXIMUM APPLICABLE TRANSIENT CURRENT AS A FUNCTION OF PULSE DURATION,
320 V TO 680 V (RMS); 2381 596 / VDRS20.....E**

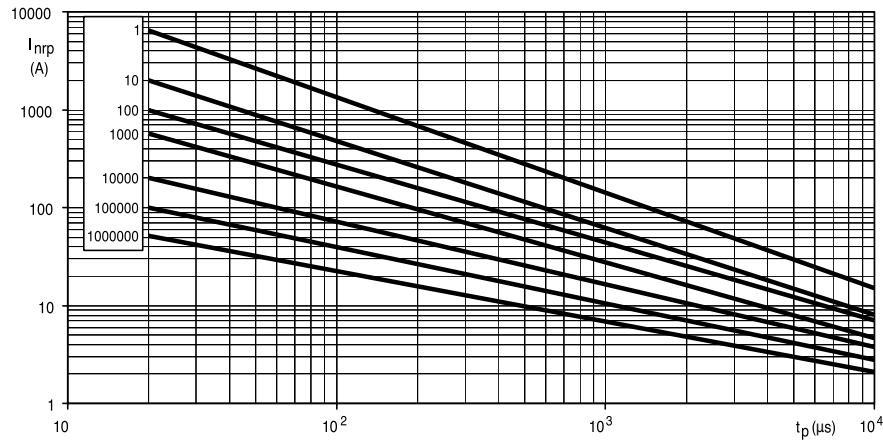



Notice

Specifications of the products displayed herein are subject to change without notice. Vishay Intertechnology, Inc., or anyone on its behalf, assumes no responsibility or liability for any errors or inaccuracies.

Information contained herein is intended to provide a product description only. No license, express or implied, by estoppel or otherwise, to any intellectual property rights is granted by this document. Except as provided in Vishay's terms and conditions of sale for such products, Vishay assumes no liability whatsoever, and disclaims any express or implied warranty, relating to sale and/or use of Vishay products including liability or warranties relating to fitness for a particular purpose, merchantability, or infringement of any patent, copyright, or other intellectual property right.

The products shown herein are not designed for use in medical, life-saving, or life-sustaining applications. Customers using or selling these products for use in such applications do so at their own risk and agree to fully indemnify Vishay for any damages resulting from such improper use or sale.