

ISSUE NO. : G5-97023

DATE OF ISSUE : JUL. 31. 1997

CLASSIFICATION: NEW CHANGED REVISED

PRODUCT SPECIFICATION FOR INFORMATION

PRODUCT DESCRIPTION : THERMAL PRINTER UNIT

PRODUCT PART NUMBER : EPL1801S2E

CLASSIFICATION OF SPEC : PRODUCT SPECIFICATION

APPLICATIONS : Portable EFT-POS

: For other application, contact our person signed below.

TERM OF VALIDITY : JUL 30, 2002 from the date of issue

CUSTOMER USE ONLY COPIES WAS CERTAINLY RECEIVED BY US. ONE COPY IS BEING RETURNED TO YOU.	RECEIPT RECORD #:
	DATE OF RECEIPT :
	RECEIVED BY :
	TITLE DEPT.

MATSUSHITA ELECTRONIC COMPONENTS CO., LTD.
ELECTROMECHANICAL COMPONENTS DIVISION
〒571 1006 KADOMA, OSAKA, JAPAN
TEL: OSAKA (06)908-1101 (REPRESENTATIVE)
FAX: OSAKA (06)908-3634 (DIRECT)

PREPARED BY	: ENGINEERING SECTION 1
ENGINEER	: <i>K. Toyota</i>
SENIOR ENGINEER	: <i>S. Shiraga</i>
MANAGER	: <i>T. Tanaka</i>
GENERAL MANAGER	: <i>J. Kajim</i>

Document	Product specifications	Mark-number : 151 - GT-077
Product	EPL1801S2E	36 - 1 Revision-number:0

TABLE OF CONTENTS

1. Cautions	-----3
1-1. Safe operation	-----3
1-1-1. The thermal head	-----3
1-1-2. The motor	-----3
1-1-3. Others	-----3
1-2. Precautions in use	-----4
1-2-1. The thermal head	-----4
1-2-2. The motor	-----4
1-2-3. The recording paper	-----5
1-2-4. Printer installation, Case design	-----6
1-2-5. The FPC and connector	-----7
1-2-6. The power supply	-----7
1-2-7. Environment and printing condition	-----7
1-2-8. Storage, Maintain	-----8
1-2-9. The product and the specification	-----9
2. General specification	-----10
3. Recording paper	-----12
4. Reliability characteristics	-----12
5. Quality of printing	-----13
6. Thermal head specifications	-----14
6-1. The structure of a head	-----14
6-2. Head rank	-----15
6-3. General specification	-----16
6-4. Electric characteristics	-----17
6-4-1. Electric characteristics	-----17
6-4-2. Timing chart	-----18
6-5. Applied pulse width control	-----19
6-5-1. Standard applied energy	-----19
6-5-2. Pulse width calculation	-----19
6-5-3. Printing cycle correction	-----19
6-5-4. Divided correction	-----20
6-5-5. Simultaneous coloring correction	-----20
6-5-6. Energy adjustment for various kinds of paper	-----20
6-5-7. Thermal hysteresis control	-----21
6-5-8. Double(2PLY) paper control	-----22
6-6. Precautions in use	-----23
6-6-1. Electric precautions	-----23
6-6-2. Mechanical precautions	-----23
6-6-3. Recommended driving circuit conditions	-----23

Note,		Format No. FORM1061. JBW
Established JUL/31/97	Electronic Devices Department Electromechanical Components Division Matsushita Electronic Components Co., Ltd	In charge of : <i>A. Toyota</i>
Enforced JUL/31/97		Checked by : <i>S. Shiraga</i>
		Manager : <i>T. Tanaka</i>
		General Manager: <i>J. Kagami</i>

Document	Product specifications	Mark-number : 151 -- GT-077
Product	EPL1801S2E	36 - 3 Revision-number:0

I. Cautions

1-1. Safe operation



In case of operating this printer, keep following items for safety.

1-1-1. The thermal head

(1). The temperature of the thermal head becomes high, so do not touch the thermal head or the thermal head supporting part(heat spreader) while printing or just after operation. Pay attention at maintenance or replacing the recording paper, too.

(2). When the thermal head falls into continuous ON state for some trouble, it may cause smoke or catch fire from the paper by the temperature of the thermal head. Or the power supply may be influenced by deformed or shorten FPC because of the high temperature.

To avoid above situation, follow the followings to turn off the power immediately when the thermal head falls into continuous ON state.

①The thermal head has a thermistor to detect temperature.

Design a protecting circuit not to be operated at out of specified temperature range.

②Design the circuit to cut off the power when the thermistor is SHORT or OPEN.



1-1-2. The motor

(1). The temperature of the motor and the motor supporting parts become high, so do not touch the motor while printing or just after operation.

(2). When the motor falls into continuous driven state by some trouble, it may cause smoke or catch fire. When the motor is locked by PAPER JAMMING or being put foreign substances to gears, it may cause a burn by over heated motor or a breaking gears.

In order to avoid the danger case as mentioned above, equip the protection method in the sets in which the printer is installed as follows.

This printer has a thermistor to detect a motor temperature. Design a protecting circuit in order to protect into operate at out of specified temperature range.

Design the circuit to cut off the power when detecting the thermistor SHORT or OPEN.

(3). Design the protection circuit to avoid continuous driven state because of CPU trouble.

1-1-3. OTHERS

(1). Do not put in liquid like water or conductive material like metal.

It may cause that thermal head will be broken or power supply will be shorten and occur smoke or catch fire.

(2). Do not put fingers and so on into rotating gears. Fingers may be injured.

(3). Be careful not to touch the edges(especially heat spreader of the head).

The sharp cut edges can scratch person's fingers.

(4). If it happens trouble for the worst, TURN OFF the power.

Note

Format No.
FORM1062. J8W

Established
JUL/31/97

Enforced
JUL/31/97

Electronic Devices Department
Electromechanical Components Division
Matsushita Electronic Components Co., Ltd

Document	Product specifications	Mark-number : 151-GT-077
Product	EPL1801S2E	36-4 Revision-number:0

1-2. Precautions in use

1-2-1. The thermal head

- (1). The life of the thermal head may become shorter, if oil of finger etc. sticks to the head. In case oils or foreign substances stick to the head, clean up the thermal head immediately. SEE 1-2-8. Maintain
- (2). To protect the thermal head or thermal head driver, detect the temperature by the thermistor, located on the head and do not operate the thermal head at 70°C or higher temperature.
- (3). Do not apply the energy to the head, when the thermistor is opened.
- (4). The thermal head may be corroded, by following conditions.
 - ① Much ions included in the recording paper
 - ② High humidity or dew condensed condition
 - ③ Power applied to the thermal head
 Therefore keep followings.
 - Cut off the power to the thermal head when the printer is not operating.
 - Use dry recording paper, because wet paper makes poor printing quality and it causes corrosion of the thermal head.
- (5). Use the thermal head at the specified voltage and pulse width. or deterioration in the printing quality or damage to the head may be caused.

1-2-2. The motor

- (1). Temperature of the motor becomes high. Pay attention to design the case of system around the motor radiation, distance between motor and case, case material, etc.
- (2). The surface temperature of the motor should be under 80°C.
This printer has a thermistor to detect a motor temperature.
- (3). Stop the operation when the motor is locked mechanically because of paper jamming etc. The lock may cause abnormal high temperature of the motor or broken gears.
- (4). Design the circuit to cut off the power if it happens that motor is locked electrically.
- (5). To avoid the abnormal high temperature of the motor, do not supply the power to the motor except printing or feeding operation.

Note

Established JUL/31/97	Electronic Devices Department Electromechanical Components Division Matsushita Electronic Components Co., Ltd	Format No. FORM1062. JBW
Enforced JUL/31/97		

Document	Product specifications	Mark-number : 151 - GT - 077
Product	EPL1801S2E	36 - 5 Revision-number:0

1-2-3. The recording paper

- (1). This printer's specification is guaranteed under the recommended paper.
 Use the recommended paper.
 Un-recommended papers may cause the poor printing and get worse the reliability of the printer.
 To use un-recommended papers, evaluate sufficiently before mass-production.
- (2). Pay attention that the recommended paper has restriction of operating environment or depend on each paper's characteristics.
- (3). Evaluate the paper sufficiently before mass-production to use perforation or the roll paper cored side in.
 Printing quality and output level of paper end sensor will be influenced by direction of the flash, or stiffness of perforation.
- (4). Be careful of the stock and treating of recording paper.
 - Do not store the paper at high temperature & humidity, because it may be colored itself at over 60°C.
 - Store the paper at cool & dark place. Do not store long time in direct sunlight condition.
 - Discoloring may be caused by ESTER ERASER, TAPE ADHESIVE, PLASTIC FILM include PLASTICIZER.
 - Coloring may be caused by facing to ORGANIC SOLVENT or diazo-copy, nail scratching.

Note		Format No. FORM1062 JBW
Established JUL/31/97	Electronic Devices Department Electromechanical Components Division Matsushita Electronic Components Co., Ltd	
Enforced JUL/31/97		

Document	Product specifications	Mark-number : 151 - GT - 077
Product	EPL1801S2E	36 - 6 Revision-number:0

1-2-4. Printer installation. Case design

- (1). Mounting the FPC in stretch condition, causes poor printing quality.
Design the connector position to give the slack to the FPC.
- (2). If static electricity is applied to the printer, the thermal head may be damaged.
To avoid this, connect the METAL PLATE to the frame ground of the main unit.
- (3). Take measures in designing so as to minimize the lateral position deviation of the paper holder from the paper inlet of the printer. In case of using roll paper, hold the paper so that the roll core(BAR) of the paper is parallel to the printer, or it may cause paper skew or jamming.

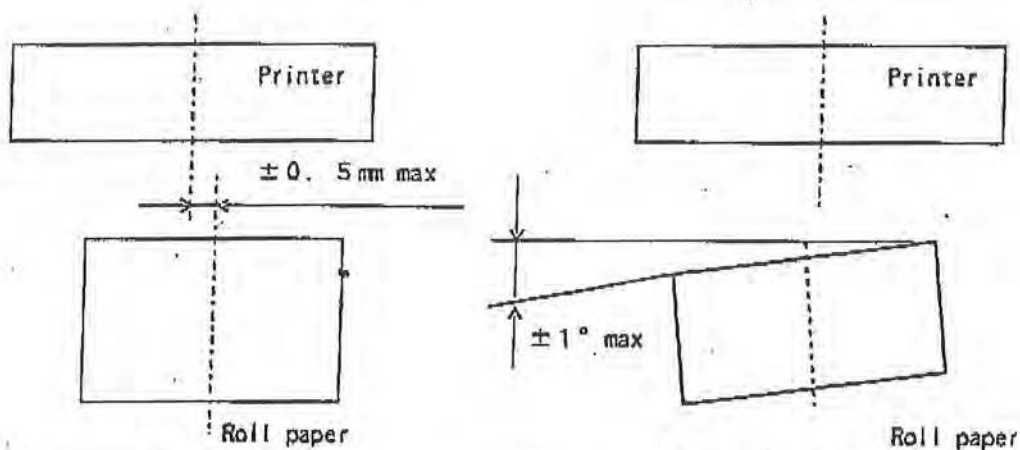

- (4). At fixing, be careful not to apply the excessive force or torsion to the printer main body. Deformation or torsion may cause the poor printing quality, paper skew, paper jamming. Design the flatness of the printer mounting spot less than 0.2mm.
- (5). Using of cushion rubber on the printer installing position reduces the running noise level.
- (6). Design the case not to re-enter the paper to the printer(PLATEN).
- (7). This printer does not have the special structure of guard against dust or water. Design the case suitably.
- (8). Metal Parts(ESPECIALLY CUT EDGES) may gather rust. Design the case not to spoil the beauty of the design.

Note

Format No.
FORM1062. JBW

Established
JUL/31/97

Enforced
JUL/31/97

Electronic Devices Department
Electromechanical Components Division
Matsushita Electronic Components Co., Ltd

Document	Product specifications	Mark-number : 151 - GT - 077
Product	EPL1801S2E	36 - 7 Revision-number:0

1-2-5. The FPC and CONNECTOR

- (1). When the FPC is put on to a connector, or pulled out from a connector, cut off the power.
- (2). Pay attention to the contact face direction and put the FPC completely.
- (3). Use the recommended connector.
Evaluate the specifications (POWER RATING, CONTACT RESISTANCE, WITHDRAWING FORCES etc.), when using un-recommended connector.
- (4). Do not bend FPC because FPC may be broken.

1-2-6. The power supply

(1). Power ON/OFF order

If an abnormal pulse is applied to the thermal head at power ON/OFF, the head may be destroyed.

To avoid this, the special attention shown below shall be paid to the circuit so that no abnormal pulses are applied to the thermal head.

AT POWER ON : LOGIC (Vdd) ON → THERMAL HEAD (VP) ON
 AT POWER OFF : THERMAL HEAD (VP) OFF → LOGIC (Vdd) OFF

- (2). Use the power supply which has enough capacity.
The power supply which does not have enough capacity may cause poor printing quality.
- (3). To operate by BATTERY, pay attention to voltage drop by internal resistance and upper/lower limit voltage of BATTERY.

1-2-7. Environment and printing condition

- (1). Avoid a dusty place.
- (2). Avoid the place near the machine that occurs large radiation noise.
EXAMPLE : HIGH VOLTAGE EQUIPMENT, LARGE SIZED MOTOR
- (3). Operate the printer with the paper and head down condition.
Operating it without paper may cause poor printing quality and trouble of gear parts etc.
- (4). Operating it with head up condition may cause breakdown of the thermal head.
To avoid this, the UP/ DOWN state of the head is detected with mechanical contact switch.

Note

Format No.
FORM1062 JBW

Established
JUL/31/97

Enforced
JUL/31/97

Electronic Devices Department
 Electromechanical Components Division
 Matsushita Electronic Components Co., Ltd

Document	Product specifications	Mark-number : 151 - GT - 077
Product	EPL1801S2E	36 - 8 Revision-number:0

1-2-8. Storage, Maintain

(1). How to clean up the thermal head

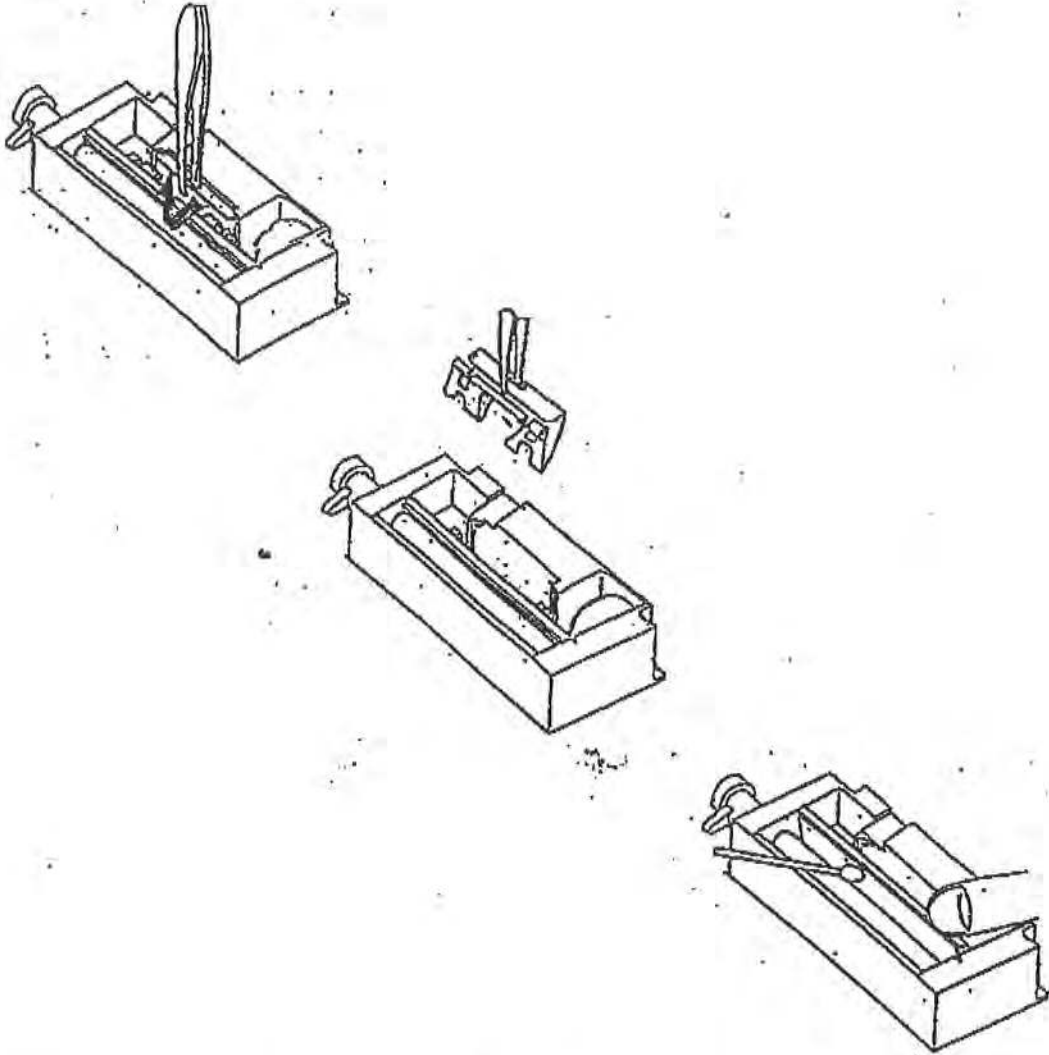

- Pay attention not to scratch the surface of the thermal head and platen.
- Clean up the thermal head by cotton bar with METHANOL or IPA.
- Insert the paper after drying up the thermal head completely.

(2). Keep the head in up state during transportation or long term storage.

If the platen is being pressed by the head for a long time.

It may be deformed, and printing quality may be uneven.

(3). When handling the printer, do not touch the FPC terminal, because the LSI is used in the head.
Wear the earthband while handling.

(4). Avoid to storage at the place where are much dust or occur the condensed dew.

(5). Any SERVICE PARTS is not provided for this product.

Note

Format No.
FORMT062 JBW

Established
JUL/31/97

Enforced
JUL/31/97

Electronic Devices Department
Electromechanical Components Division
Matsushita Electronic Components Co., Ltd

Document	Product specifications	Mark-number : 151 - GT - 077
Product	EPL1801S2E	36 - 9 Revision-number:0

1-2-9 The product and the specification

- (1). The design and the specifications of the document may be changed for improvement without prior notification. However, we shall in advance notify you of the changes that may affect the specifications of your products.
- (2). Please be noted in advance that we shall bear no responsibility regarding violation of rights such as intellectual property possessed by the third person occurring by use of information and drawings contained in these specifications for anything other than this product.
We shall not guarantee that information and drawings contained in these specifications do not violate rights of intellectual property possessed by the third person except for cases in which there is a written agreement between a customer and this company.
- (3). Any part or whole of this document shall not be reproduced or copied without prior consent of us.
- (4). In case of any trouble, both parties shall discuss them based on the items mentioned in this document. The warranty relating to these troubles shall be limited only to the printer.
- (5). In the event of troubles attributable to the defects of our product, the remedies of us shall be limited to the cost of those specified products.
- (6). Applicability of rule or standard to this printer shall be concerned by customer side. If you can not accept, please inform us.
- (7). The warranty period on the printer is fifteen(15)months after being produced in Matsushita Electronic Components Co., Ltd.
No warranty is provided on any troubles beyond this period of time, or on troubles attributable to user's negligence even during the warranty period.

Note		Format No. FORM1052 JBW
Established JUL/31/97	Electronic Devices Department Electromechanical Components Division Matsushita Electronic Components Co., Ltd	
Enforced JUL/31/97		

Document	Product specifications	Mark-number : 151 - GT - 077
Product	EPL1801S2E	36-10 Revision-number:0

2. General specifications

(At 25±5°C, 60±15%RH)

(Vp: Supplied voltage to head, motor)

Item		Specification	Remark
Printing method		Direct thermal, line-dot printing	
Paper width		58.1 mm	
Effective printing width		48 mm	
Total number of dots		384 dots/line	
Head density		8 dots/mm	
Maximum printing speed		450 dot-line/s max.	at Vp=7.2V or more, 20°C or more 64 dots coloring (standard thermal paper)
Number of dots colored at the same time		64 dots max.	For more than 64 dots divide printing is needed.
Horizontal dot pitch		0.125 mm	
Vertical dot pitch		0.125 mm	One dot paper-feed pitch
Vertical dot pitch accuracy		±0.1 mm/line max.	Vp=7.2V, f=900pps
Cumulative paper-feed accuracy		± 2 %	
Minimum paper-feed pitch		0.0625 mm	By motor 1 step feeding
Detecting function	Head temperature	Detect by thermistor installed in the head	
	Motor temperature	Detect by thermistor	
	Paper absence	Detect by reflection type photo interrupter	
	Head raise	Detect by mechanical switch	
Operating voltage	Vp (for head, motor)	DC 4.2V - 8.5V	Ni-MH, Ni-Cd battery : 5-6 cells Li-ion battery : 2 cells
	Vdd system (for logic)	DC 5 V±8%	For head driver IC and sensors
Current consumption	Head (In case of coloring 64 dots at the same time)	2.7 A max.	At Vp=7.2V and minimum resistance
		Average 1.3 A	At Vp=7.2V, 170Ω, 25°C, 450DL/s and standard thermal paper.
	Motor	2.1 A max.	At 8.5V
		Average 0.90 A	At Vp=7.2V, f=900PPS

Note

Established JUL/31/97	Electronic Devices Department Electromechanical Components Division Matsushita Electronic Components Co., Ltd	Format No. FORM1062. JBW
Enforced JUL/31/97		

Document	Product specifications	Mark-number : 151-GT-077
Product	EPL1801S2E	36-11 Revision-number:0

Paper feeding force	0.75 N (77 gf) min	Vp=7.2V, f=900pps	
Paper holding force	2 N (204 gf) min		
Running noise	55 dB max.	Measured at 1 meter distance, A curve, slow. (Vp=7.2V, f=900pps)	
Weight	38 g		
External dimensions	72 × 32 × 15 mm	Except the paper feeding knob, release lever, and FPC.	
Life #1	Pulse life: MCTF 1×10^8 pulses Wear resistance: 50 km (Printing rate: 12.5%) (Definition) The change of resistance rate: 15% max. Dot lack: 0.5% max ※In case of 2ply paper printing, the actual pulse life corresponds to about 5×10^7 pulses due to color 2 times in a row at the same dot-line position, because it is required to supply about 2 times higher energy than requirement energy for standard thermal paper.	Rated energy (Vp=7.2V). Recommended recording paper.	
Mechanical characteristics	Release lever operating force	5 N (510 gf) max.	
	Number of release lever operations	30000 times min.	
	Handle turning torque	30 mN·m (306 gf·cm) max.	Recording paper kept free.
	Paper loading method	manual loading automatic loading	
	Paper feed direction	forward/backward	at backward feed limit to 300mm max. except perforation lines
	Continuous operation time	It depends on operating condition. (Limitation: Head temp. 70°C max. Motor temp. 80°C max.)	

#1 TEST PRINT PATTERN
12.5% ZEBRA pattern

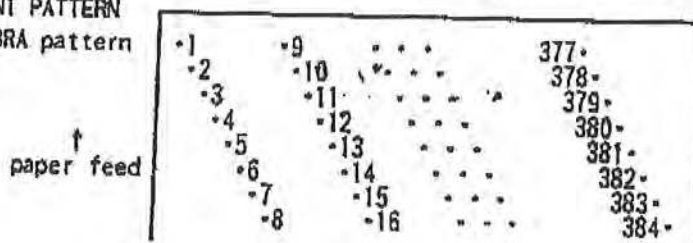

Note

Established JUL/31/97	Electronic Devices Department Electromechanical Components Division Matsushita Electronic Components Co., Ltd	Format No. FORM1062. JBW
Enforced JUL/31/97		

Document	Product specifications	Mark-number : 151 - GT - 077
Product	EPL1801S2E	36-12 Revision-number:0

3. Recommended thermal paper

Type	Recommended paper (paper width: 58.8 mm)
Standard thermal paper	Mitsubishi Seishi : F200U9W6 Nippon paper(Jujo Seishi) : TF50KS-E2
High preservation thermal paper	Mitsubishi Seishi : AFP235B
Double paper (2ply)	Fujicopian : TCC

Un-recommended paper may get worse the reliability of the thermal head.
And it may cause the poor printing (for example sticking).
To use un-recommended paper, evaluate sufficiently before mass-production.

4. Reliability characteristics

Item	Conditions	Remarks
Operating environment	Temperature: -5°C to +50°C Humidity : 35 to 85% RH ※ Double paper TCC : 5~40°C, 45~85 %RH	After 3 hours of storage under these conditions, no malfunction shall occur. (Printing quality is reliable from 0°C to 40°C.)
Storage environment	Temperature: -25°C to +70°C Humidity: 5 to 90% RH	After the printer is stored for 72 hours under these conditions and is allowed to stand for 2 hours at normal temperature and humidity, no malfunction shall occur during operation. The storage test shall be conducted with the head kept up. There shall be no condensation. The recording paper shall be excluded.
Vibration resistance	At operation: 3.92m/s ² , 5 to 100 Hz in frequency, 3 directions perpendicular to one another, 15 minutes for each direction At non-operation: 9.8m/s ² , 5 to 100 Hz in frequency, 3 directions perpendicular to one another, 1 hour for each direction	After testing under these conditions, no malfunction shall occur.
Impact resistance	588m/s ² , 11 ms 6 directions, 1 time for each direction	After testing under these conditions, no malfunction shall occur.

Note

Established JUL/31/97	Electronic Devices Department Electromechanical Components Division Matsushita Electronic Components Co., Ltd	Format No. FORM1062 JBW
Enforced JUL/31/97		

Document	Product specifications	Mark-number : 151 - GI - 077
Product	EPL1801S2E	36-14 Revision-number:0

6. Thermal head specifications

6-1. The structure of a head

This thermal head has 6 data input terminals and 1 strobe terminal.

Each data input is connected to each block which is constructed shift register, Latch, and driver IC each of them has 64 elements.

When divided printing, printing data shall be input as divided into 64-dot.

Block diagram and direction of data inputting are as shown below.

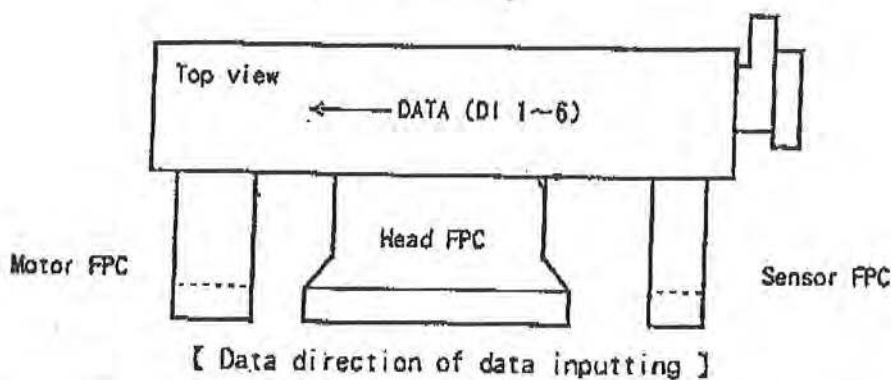
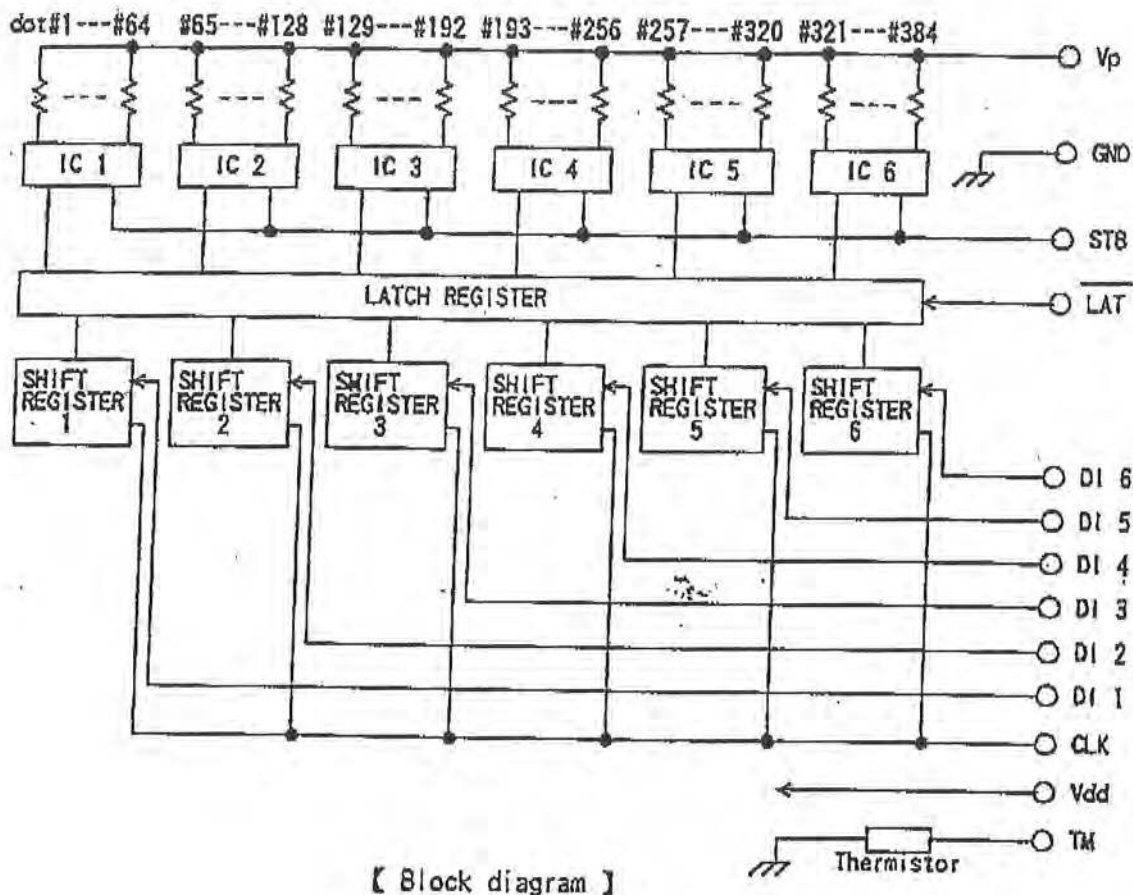

Note

Established
JUL/31/97
Enforced
JUL/31/97

Format No.
FORM1062. JBW

Electronic Devices Department
Electromechanical Components Division
Matsushita Electronic Components Co., Ltd

Document	Product specifications	Mark-number : 151 - GT-077
Product	EPL1801S2E	36-15 Revision-number:0

6-2. Head rank

There are 4 head ranks according to the average resistance value as shown below. By reading "RANK1" and "RANK2" in head FPC(refer to 8-2.), automatic setting of the head rank can be performed.

1 : OPEN , 0 : GND

Head rank	RANK 1	RANK 2	Average resistance value (Ω)
A	0	0	184~195
B	1	0	171~183
C	0	1	157~170
D	1	1	145~156

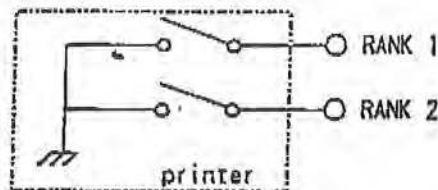

Note

Format No.
FORM1062. JBW

Established
JUL/31/97

Enforced
JUL/31/97

Electronic Devices Department
Electromechanical Components Division
Matsushita Electronic Components Co., Ltd

Document	Product specifications	Mark-number : 151 - GT - 077
Product	EPL1801S2E	36-16 Revision-number:0

6-3. General specifications

Item	Specifications
Printing width	48 ± 0.2 mm
Total number of dots	384 dots/line
Dot density	8 dots/mm
Dot pitch	0.125 mm
Resistance	170 Ω ± 15 %
Number of strobes	1 strobes
DATA transfer system	6 DATA input system
Driver setup	6 drivers (in units of 64 dots)
Applied voltage	4.2V to 8.5V
Applied pulse width	*1 1.2 ms (Typ)
Applied pulse period	2.2 ms (min)
Applied power	0.22 W/dot (Typ)
Number of dots printable at the same time	64 dots max.
Thermistor characteristics	$R_x = R_{25} \times \text{EXP}\{B \times (1/(273 + T_x) - 1/298)\}$ R_x : kΩ (at $T_x(^{\circ}\text{C})$) R_{25-c} : 30 kΩ ± 5% (at 25°C) B constant: 3950k ± 2% T_x : °C
Notes	Applied power = $I_o^2 \cdot R_{av}$ $I_o = \frac{V_p^2 \times R_{av}}{(N \cdot R_{com} + R_{av} + R_{ic} + R_l)^2}$ (W/dot) where R_{av} : Average resistance value 170 Ω N : Number of printing dots at same time 64 dots (max.) R_{com} : Common resistance value 0.05 Ω R_{ic} : Driver IC resistance 16 Ω R_l : Lead resistance value 10 Ω

*1 Standard thermal paper, at 7.2V, at 20°C, 64 dots coloring.

Note		Format No. FORM1062. JBW
Established JUL/31/97	Electronic Devices Department Electromechanical Components Division Matsushita Electronic Components Co., Ltd	
Enforced JUL/31/97		

Document	Product specifications	Mark-number : 151-GT-077
Product	EPL1801S2E	36-17 Revision-number:0

6-4. Electric characteristics

6-4-1. Electric characteristics (Temperature:5°C-45°C, Humidity:35-85%RH)

Item	Symbol	Recommended values			Unit	Conditions
		Min.	TYP	Max.		
Power source voltage	Vp	—	—	8.5	V	
Power source voltage	Vdd	4.60	5.00	5.40	V	
Power source current	Idd	—	—	48	mA	fDI=fCLK/2
Input voltage	H VIH	0.8Vdd	—	Vdd	V	STB, DI, LAT, CLK
	L VIL	0	—	0.2Vdd	V	"
Data input current (DI1~6)	H IIH DI	—	—	0.5	μA	VIH=5V
	L IIL DI	-0.5	—	—	μA	VIL=0V
STB input current (STB)	H IIH STB	—	—	30	μA	
	L IIL STB	-0.5	—	—	μA	
CLOCK input current (CLK)	H IIH CLK	—	—	0.5	μA	
	L IIL CLK	-0.5	—	—	μA	
LATCH input current (LAT)	H IIH LAT	—	—	0.5	μA	
	L IIL LAT	-0.5	—	—	μA	
Driver output voltage	VOL	—	(1.0)	—	V	(reference)
Clock frequency	fCLK	—	—	8	MHz	
Clock pulse width	tw CLK	30	—	—	ns	Refer to 6-4-2. Timing chart.
Data setup time	tsetup DI	30	—	—	ns	
Data hold time	thold DI	10	—	—	ns	
LAT pulse width	tw LAT	100	—	—	ns	
LAT setup time	tsetup LAT	200	—	—	ns	
LAT hold time	thold LAT	50	—	—	ns	
STB setup time	tsetup STB	300	—	—	ns	
Output delay time	tdo	—	—	10	μs	

Note

Format No.
FORM1062, JBW

Established
JUL/31/97

Enforced
JUL/31/97

Electronic Devices Department
Electromechanical Components Division
Matsushita Electronic Components Co., Ltd

Document	Product specifications	Mark-number : 151-GT-077
Product	EPL1801S2E	36-18 Revision-number:0

6-4-2. Timing chart

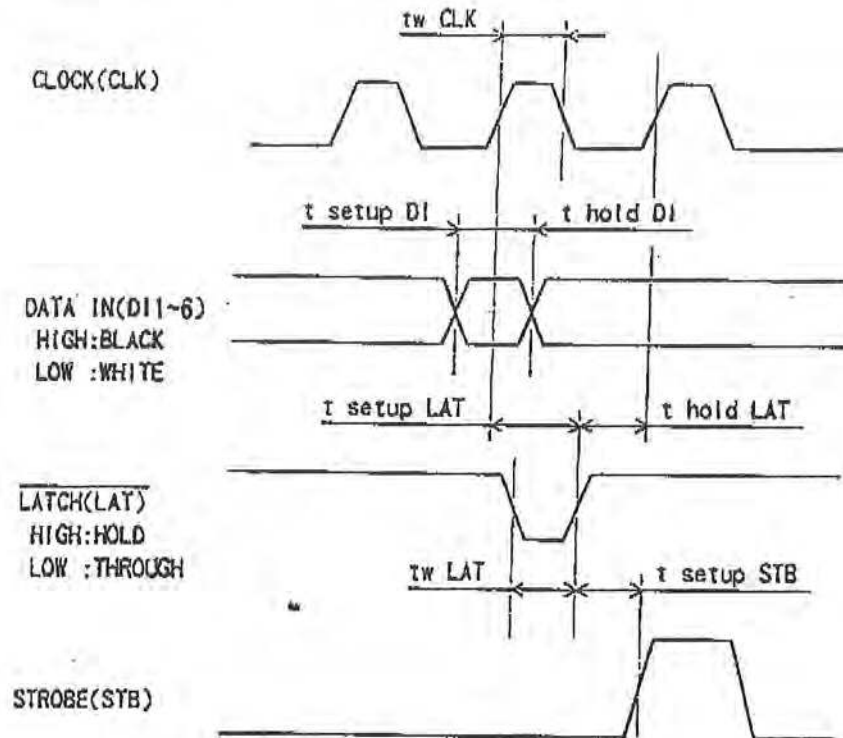

Note

Established JUL/31/97
Enforced JUL/31/97

Format No. FORM1062-JBW
Electronic Devices Department Electromechanical Components Division Matsushita Electronic Components Co., Ltd

Document	Product specifications	Mark-number : 151 - GT-077
Product	EPL1801S2E	36-19 Revision-number:0

6-5. Applied pulse width control

In order to realize a high quality printing, it is required to correct the applied pulse width depending on a supplied voltage, a temperature of the head, and a number of dots colored at the same time.

The following is the method how to calculate the pulse width.

6-5-1. Standard applied energy

The standard applied energy is as follows;

$$E_0 = 0.230 \text{ mJ (constant)}$$

6-5-2. Conversion of the energy into pulse width

Convert the standard applied energy to head pulse width with factors of supplied voltage and head temperature correction according to the following formula.

$$T_1 = \frac{E_0}{W} \times \left\{ 1 + \frac{\alpha}{100} \times (20 - T) \right\} \quad (\text{ms})$$

t : applied pulse width (ms)

E_0 : applied energy (mJ)

$$W : \text{applied wattage} = \frac{V_p^2 \times R_{av}}{(8 \times 0.05 + R_{av} + 26)^2} \quad (\text{W/dot})$$

V_p : Supplied Voltage (V)

R_{av} : Thermal Head resistance (Ω)

	Head tank(Refer to 6-2.)			
	A	B	C	D
$R_{av}(\Omega)$	190	177	164	150

α : Temperature correction ratio $\rightarrow 1.1$ (%/deg)

T : Temperature of thermal head ($^{\circ}\text{C}$)

6-5-3. Printing cycle correction

Correct the pulse width depending on a printing cycle according to the following formula.

Printing cycle correction ratio is shown in the following table.

$$T_2 = (1 + X/100) \times T_1$$

T_2 : Head pulse width

X : printing cycle compensating ratio (%)

[Printing cycle compensating ratio: X]

Head temperature \ Head voltage	4.2V - 4.5V	4.5V - 5.0V	5.0V - 5.5V	5.5V - 6.0V	6.0V - 7.0V	7.0V - 8.5V
	-5~5 $^{\circ}\text{C}$	240	150	90	63	36
5~20 $^{\circ}\text{C}$	188	121	82	40	27	5
20~35 $^{\circ}\text{C}$	133	86	50	31	10	0
35~50 $^{\circ}\text{C}$	90	53	31	17	10	0
50~70 $^{\circ}\text{C}$	69	29	25	17	10	0

Note

Format No.
FORM1062 JBW

Established
JUL/31/97

Enforced
JUL/31/97

Electronic Devices Department
Electromechanical Components Division
Matsushita Electronic Components Co., Ltd

Document	Product specifications	Mark-number : 151 - GT - 077
Product	EPL1801S2E	36 - 20 Revision-number:0

6-5-4. Divide correction

Correct the pulse width depending on a number of dividing, according to the following formula. Divide correction ratio is shown in the following table.

$$T_1 = (1 + Y/100) \times T_2$$

T_2 : Head pulse width
 Y : Divide correction ratio (%)

[Divide correction ratio: Y]

number of dividing	Y (%)
1	0
2	0
3	1.9
4	2.7
5	3.4
6	4.2

number of dividing	Y (%)
7	5.0
8	5.8
9	6.6
10	7.3
11	8.1
12	8.9

number of dividing	Y (%)
13	9.7
14	10.5

6-5-5. Simultaneous coloring correction

Correct the pulse width depending on the number of dots colored simultaneously according to the following formula. Simultaneous coloring correction ratio is shown in following table.

$$T_1 = (1 + Z/100) \times T_2$$

T_2 : Head pulse width
 Z : Simultaneous coloring correction ratio (%)

[Simultaneous coloring correction ratio: Z]

Simultaneous printing dots	Z (%)
1 ~ 8	0
9 ~ 16	1
17 ~ 24	2
25 ~ 32	3
33 ~ 40	4
41 ~ 48	5
49 ~ 64	6

6-5-6. Energy adjustment for various kinds of paper

May correct the pulse width in order to adjust the difference of sensitivity of the kinds of thermal paper as shown below.

$$T_1 = (1 + P/100) \times T_2$$

T_2 : Head pulse width
 P : Recording paper correction ratio (%)

[Recording paper correction ratio: P]

paper type	Recording paper (manufacturer : type number)	Sensitivity compensating ratio
Standard thermal paper	Mitsubishi Seishi : F200U9W6	0
	Nippon paper : TF50KS-E2	
High preservation thermal paper	Mitsubishi Seishi : AFP235B	3.0
Double paper	TCC : TCC	3.0

Note

Format No.
FORM1062 JBW

Established
JUL/31/97

Enforced
JUL/31/97

Electronic Devices Department
Electromechanical Components Division
Matsushita Electronic Components Co., Ltd

Document	Product specifications	Mark-number : 151 - GT - 077
Product	EPL1801S2E	36 - 21 Revision-number:0

6-5-7. Thermal hysteresis control

In order to reduce a thermal head consumption, may append the thermal hysteresis control which is shown below for example.

(1) Out line

The applied pulse width which is calculated by the method through 5-5-1 to 5-5-6 divided 3 parts(①, ②, ③), and change the input data for each parts depending on the hysteresis condition.

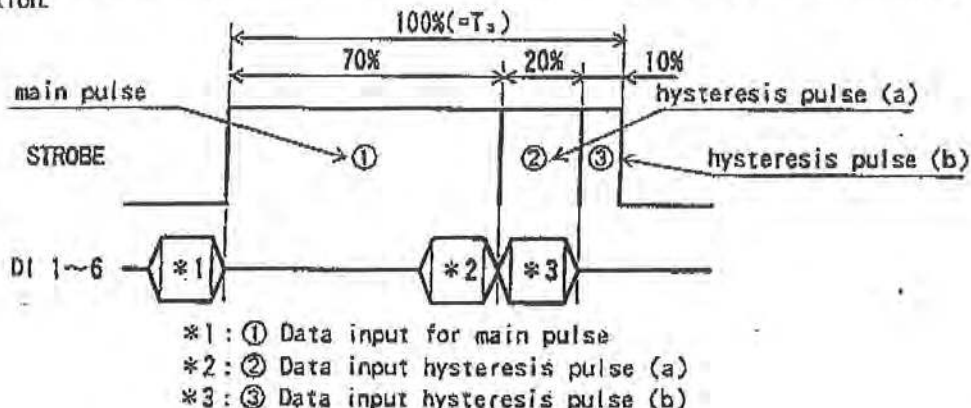

(2) Hysteresis correction ratio

There are 4 correction patterns depend on the previous 2 dots colored condition.

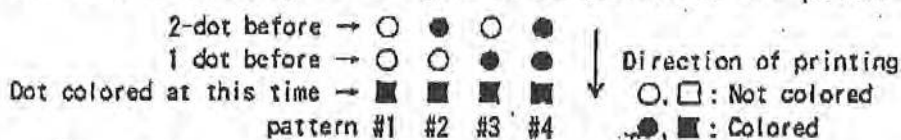

[Applied pulse ratio]

	Applied pulse ratio (%)	Applied pulse structure
pattern #1 (both 2 previous dots not colored)	100	①&②&③
#2 (colored 2-dot before)	90	①&②
#3 (colored 1 dot before)	80	①&③
#4 (both 2 previous dots colored)	70	①のみ

(3) Example of data input

	pattern #1	#2	#3	#4	
Printing direction ↓	○	●	○	●	○:Not colored ●:Colored
Dot colored at this time →	○	○	●	●	
Hysteresis correction ratio	100%	90%	80%	70%	
Data of dot colored at this time					
*1(① main pulse)	1	1	1	1	
*2(② hysteresis pulse (a))	1	1	0	0	
*3(③ hysteresis pulse (b))	1	0	1	0	

Note

Format No.
FORM1062 JBW

Established
JUL/31/97
Enforced
JUL/31/97

Electronic Devices Department
 Electromechanical Components Division
 Matsushita Electronic Components Co., Ltd

Document	Product specifications	Mark-number : 151 - GT - 077
Product	EPL1801S2E	36-22 Revision-number:0

6-5-8. Double(2PLY) paper control

In case of double paper printing, apply the pulse which is calculated by method through 6-5-1 to 6-5-7 to the head 2times in a row at the same dot-line position as shown below.

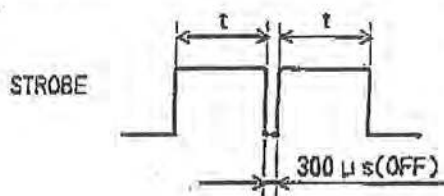

t : Applied pulse width (ms)
(to be calculated as mentioned above.)

Note

Format No.
FORM1062 JBW

Established
JUL/31/97

Enforced
JUL/31/97

Electronic Devices Department
Electromechanical Components Division
Matsushita Electronic Components Co., Ltd

Document	Product specifications	Mark-number : 151 - GT - 077
Product	EPL1801S2E	36-23 Revision-number:0

6-6. Precautions in use

6-6-1. Electric precautions

- (1) For continuous printing at high printing rate, do not allow the head substrate temperature to exceed the specified value.
- (2) To prevent the thermal head against ions, noises, etc., design the circuit so that Vp (power to the heating element) turns off (GND level) when standing by.
- (3) Design the circuit so that the thermal head is not heated in case of thermistor wire breakage.
- (4) If the number of dots printed at the same time exceeds the specified number of dots, the net power applied to the heating element decreases due to the internal voltage drop in the thermal head, so that enough density cannot be obtained. In addition, because the noise generated from the thermal head increases with increasing current, take full measures against the noise, such as the use of netting wire.

6-6-2. Mechanical precautions

- (1) Wipe off paper residues on the heating element with methanol or IPA.
- (2) Do not touch the heating element or the surface of thermal papers with the hand.
- (3) Use thermal papers which are free from Na⁺ ion, K⁺ ion, and Cl⁻ ion, or which shall be sufficiently evaluated on reliability.
- (4) Allow no condensation on the heating element.

6-6-3. Recommended driving circuit conditions

- (1) When the power turn ON/OFF,
 - When power turn ON : Tern on Vp after turned on Vdd
(Simultaneous power on is available.)
 - When power turn OFF : Tern off Vdd after turned off Vp
(Simultaneous power off is available.)
- (2) When the power turn ON/OFF, turn the STROBE to "the disable state".
- (3) In order to protect to invade a noise, the cable length from Vp and GND should be less than 100 mm.
And add an aluminum electrolytic capacitor of 47 μ F capacitance/16V between Vp and GND, and ceramic capacitor of 0.1 μ F capacitance between Vdd and GND.

Note

Established JUL/31/97	Electronic Devices Department Electromechanical Components Division Matsushita Electronic Components Co., Ltd	Format No. FORM1062 JBW
Enforced JUL/31/97		

Document	Product specifications	Mark-number : 151 - GT - 077
Product	EPL1801S2E	36-24 Revision-number:0

7. Stepping motor specifications

7-1. Basic specifications

Item	Standard
Type	Permanent magnet type
Number of phases	4
Excitation method	2-2 phase bipolar driving
Wound wire resistance/phase	9 Ω /phase
Rated voltage	4.2 ~ 8.5 V
Max. current consumption	2.1 A (at 8.5V)
Average current consumption	0.90 A (at 7.2V, 900pps)
Driving frequency	0 - 900 pps

7-2. How to operate the motor

7-2-1. General

- (1) How to drive the motor shall be excited by 2-2 phase. (Refer to 7-2-3.)
- (2) The motor shall be driven by "slow-up control", at the initial operation. (Refer to 7-2-4.)
(at the same as the re-operation of after stopping temporarily.)
- (3) The 8 dot-lines paper feeding (16 steps) shall be executed, when re-driving after stopping the motor.
- (4) The motor driving frequency shall be corrected in adopting the dynamic division printing. (Refer to 7-2-5.)
- (5) The software chopping frequency shall be 20 kHz (period:50 μ s) and the "on-time" of chopping is depending on the temperature and/or the supply voltage of the printer. (Refer to 7-2-6.)
- (6) The period until the starting of chopping after switching a phase is depending on the supply voltage of the printer.
- (7) The motor (at printing operation or paper feeding) shall be controlled by the thermistor installed on the surface of the motor, to protect the motor against the temperature increasing as follows. (Refer to 7-3.)
The motor shall be stopped over the temperature of 80 $^{\circ}$ C.
- (8) To prevent abnormal heating of the motor, do not apply power to the motor except when the paper is fed (or printed).
- (9) When restart feeding from cut off condition, it is necessary to have pre-excitation for rated time with the last excitation phase.

ote		Format No. FORM1062, JBW
Established JUL/31/97	Electronic Devices Department Electromechanical Components Division Matsushita Electronic Components Co.,Ltd	
Enforced JUL/31/97		

Document	Product specifications	Mark-number : 151-- GI-077
Product	EPL1801S2E	36-25 Revision-number:0

7-2-2. Example of driving circuit

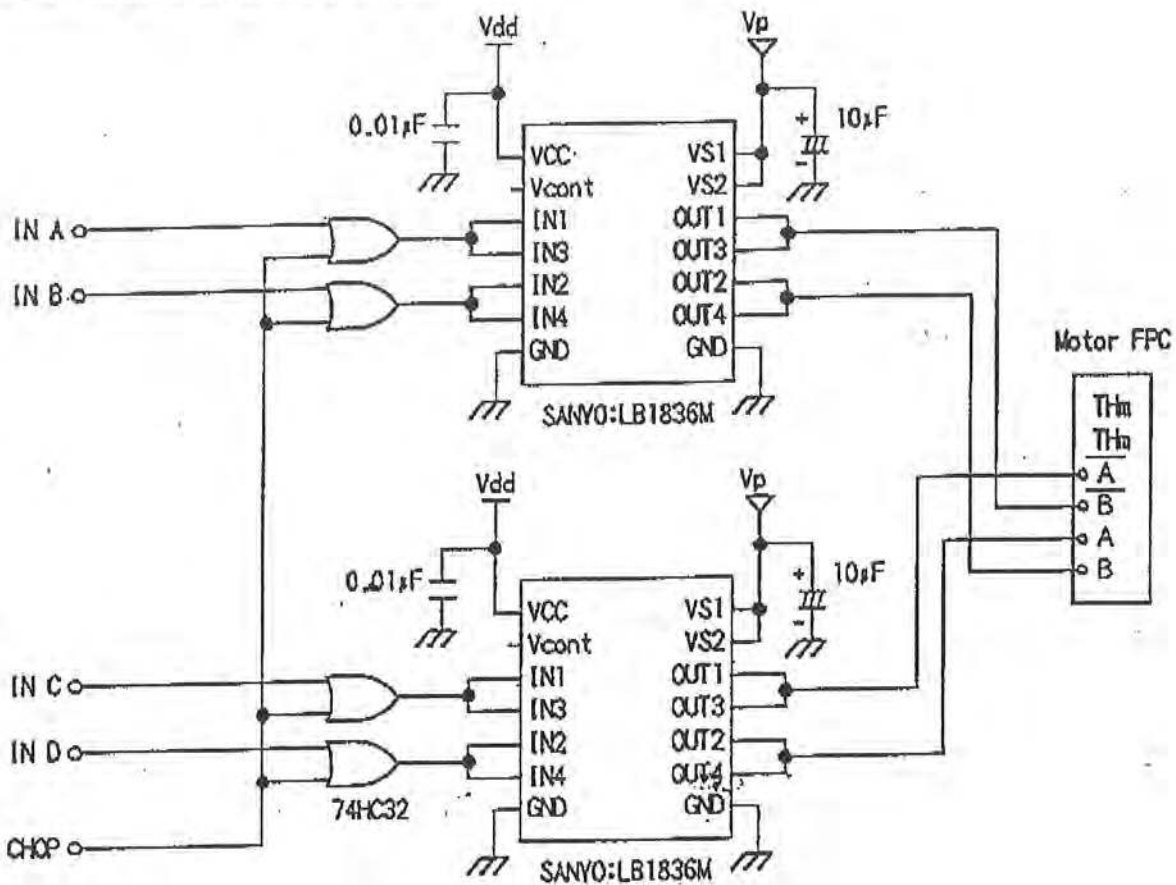

Note

Format No.
FORM1062.JBW

Established
JUL/31/97

Enforced
JUL/31/97

Electronic Devices Department
Electromechanical Components Division
Matsushita Electronic Components Co.,Ltd

Document	Product specifications	Mark-number : 151-GT-077
Product	EPL1801S2E	36-26 Revision-number:0

7-2-3. Excitation method for the stepping motor

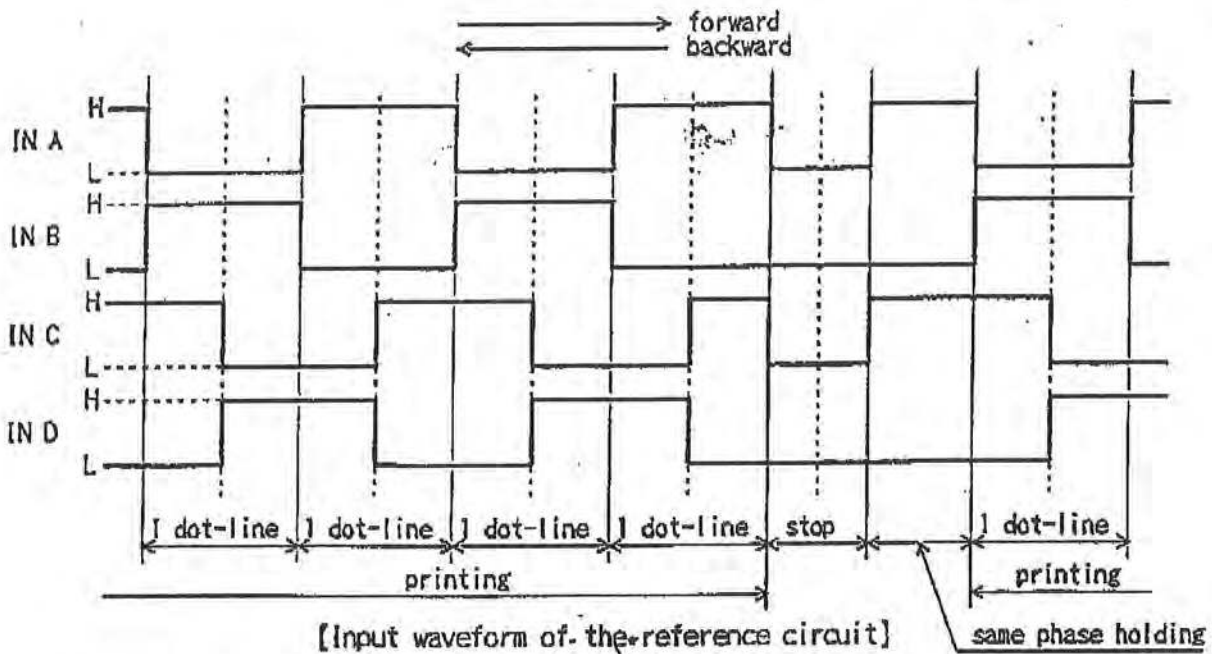
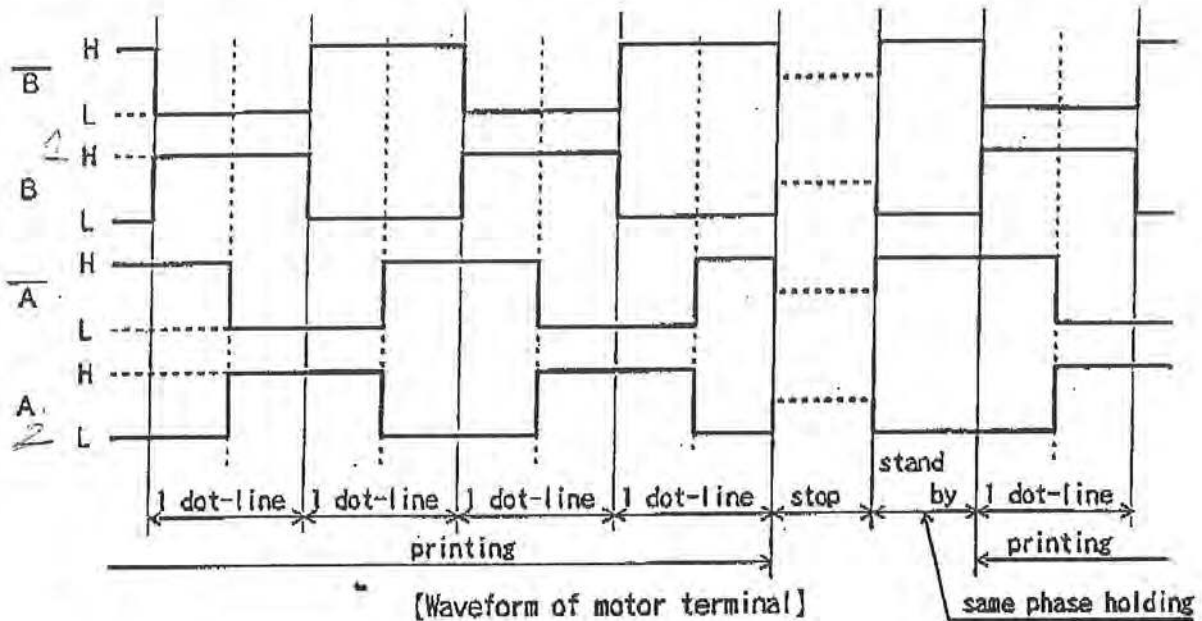

※ Dot-line/Motor step ratio : 1 dot-line/2 steps.

Note	Format No. FORM1062.JBW
Established JUL/31/97	Electronic Devices Department Electromechanical Components Division Matsushita Electronic Components Co.,Ltd
Enforced JUL/31/97	

Document	Product specifications	Mark-number : 151-GI-077
Product	EPL1801S2E	36-27 Revision-number:0

7-2-4. Slow-up and the standard frequency of the motor

Shown are the slow-up table and the standard frequency of the motor below.
(standard motor exciting period)

The motor shall not be driven over the standard motor frequency.

	Supply voltage to the printer [V]			
	5.0-5.5	5.5-6.0	6.0-7.0	7.1-8.5
Refer to the slow-up table	T a	T b	T c	T d
The standard motor frequency [pps]	300	500	800	900

<The slow-up table: T a>

step number	frequency [pps]	period [ms]
1	75	13.33
2	181	5.52
3	236	4.24
4	280	3.57
5	300	3.33
6		
7		
8		

<The slow-up table: T b>

step number	frequency [pps]	period [ms]
1	125	8.00
2	302	3.31
3	393	2.54
4	467	2.14
5	500	2.00
6		
7		
8		

<The slow-up table: T c>

step number	frequency [pps]	period [ms]
1	141	7.07
2	341	2.93
3	445	2.25
4	528	1.90
5	599	1.67
6	663	1.51
7	721	1.39
8	774	1.29
9	800	1.25

<The slow-up table: T d>

step number	frequency [pps]	period [ms]
1	159	6.29
2	384	2.60
3	501	2.00
4	594	1.68
5	674	1.48
6	745	1.34
7	811	1.23
8	871	1.15
9	900	1.11

The timing chart at slow-up is shown below.

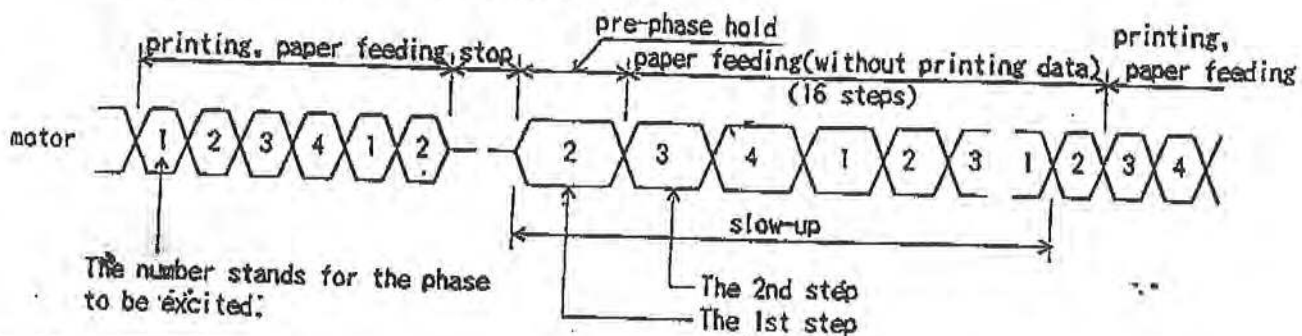

The number stands for the phase to be excited.

The 2nd step
The 1st step

Note

Established JUL/31/97.	Electronic Devices Department Electromechanical Components Division Matsushita Electronic Components Co., Ltd	Format No. FORM1062.JBW
Enforced JUL/31/97		

Document	Product specifications	Mark-number : 151-GI-077	
Product	EPL1801S2E	36-28	Revision-number:0

7-2-5. Division correction of the motor frequency at the dynamic division printing

The printing speed change every one dot-line at the dynamic division printing is minimized by this correction.

(1) Division correction method

- Definition
- ① n : The line to be colored
 - ② $n-1$: The pre-line to be fired
 - ③ M_n : The exciting time of the n -line
 - ④ $M(n-1)$: The exciting time of the $(n-1)$ -line
(The initial value : The standard motor frequency)
 - ⑤ T_{hn} : The head applied pulse width of the n -line
(The pulse width of STB signal)
 - ⑥ β : 0.8 (Correction co-efficient at the division printing)

M_n (the exciting time of n -line) shall be fixed as shown below.

(Condition 1)

Case: $2 \times (\text{The standard exciting time}) \geq T_{hn}$

M_n shall be fixed by the larger figure between the standard exciting time and $M(n-1) \times \beta$.

(Condition 2)

Case: $2 \times (\text{The standard exciting time}) < T_{hn}$

M_n shall be fixed the by the larger figure between $T_{hn}/2$ and $M(n-1) \times \beta$.

(2) Timing chart of division correction

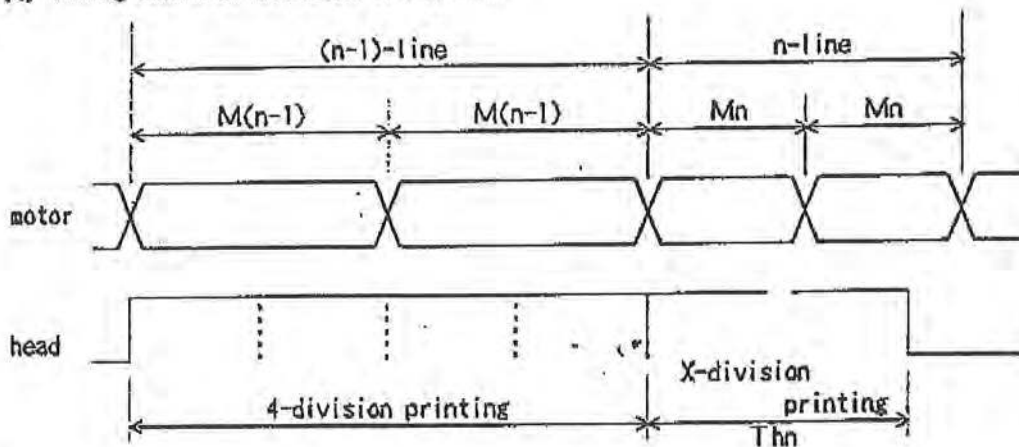

Note

Format No.
FORM1062.JBW

Established
JUL/31/97

Enforced
JUL/31/97

Electronic Devices Department
Electromechanical Components Division
Matsushita Electronic Components Co.,Ltd

Document	Product specifications	Mark-number : 151-GT-077	
Product	EPL1801S2E	36-29	Revision-number:0

7-2-6. Software chopping

(1) The starting time of chopping control after switching a phase (L_d)

L_d is defined as the period not to be chopping controlled, among the driving period (one step pulse) of the motor.

L_d is depending on the supply voltage or the temperature of the printer as shown below. The chopping control shall not be applied less than 5.5V of the supply voltage.

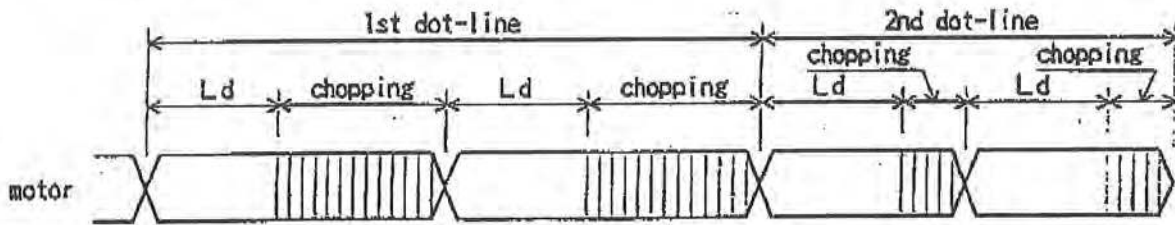

< L_d > Unit: [μs]

voltage [V]	5.0-5.5	5.5-6.0	6.0-6.5	6.5-7.0	7.0-7.5	7.5-8.0	8.0-8.5
temperature [°C]							
L_d		1000	800	560	460	370	310

(2) On time and the chopping frequency

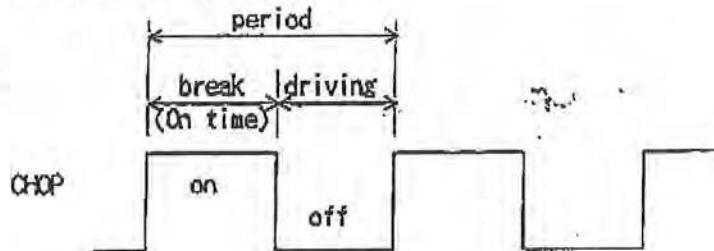

The chopping frequency : 20KHz constant (period : 50 μs)

The chopping on time : Refer to the table below

< On time > Unit: [μs]

voltage [V]	5.0-5.5	5.5-6.0	6.0-6.5	6.5-7.0	7.0-7.5	7.6-8.0	8.0-8.5
temperature [°C]							
On time		5	10	12	15	20	25

Note

Format No.
FORM1062.JBW

Established
JUL/31/97

Enforced
JUL/31/97

Electronic Devices Department
Electromechanical Components Division
Matsushita Electronic Components Co., Ltd

Document	Product specifications	Mark-number : 151 - GT - 077
Product	EPL1801S2E	36-30 Revision-number:0

7-3. Thermistor characteristics

$$R_x = R_{25} \times \text{EXP}\{B \times (1/(273 + T_x) - 1/298)\}$$

R_x : k Ω (at $T_x(^{\circ}\text{C})$)
 R_{25} : 30 k $\Omega \pm 2\%$ (at 25 $^{\circ}\text{C}$)
 B constant : 3760 K $\pm 1\%$
 T_x : $^{\circ}\text{C}$

※ The motor surface temperature shall not exceed 80 $^{\circ}\text{C}$.
 (Thermistor resistance value : 4.20 k Ω)

Note		Format No. FORM1062.JBW
Established JUL/31/97	Electronic Devices Department Electromechanical Components Division Matsushita Electronic Components Co., Ltd	
Enforced JUL/31/97		

Document	Product specifications	Mark-number : 151-GT-077
Product	EPL1801S2E	36-31 Revision-number:0

8. Sensors

8-1. Recommended circuit

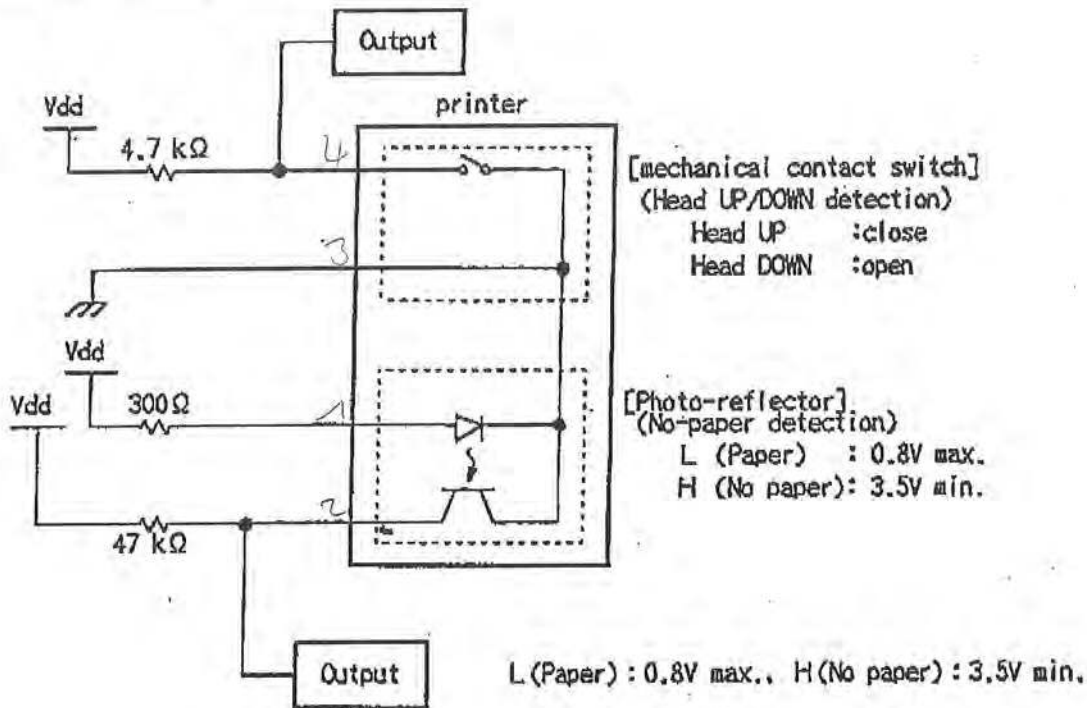

Note

Format No.
FORM1062.JBW

Established
JUL/31/97

Enforced
JUL/31/97

Electronic Devices Department
 Electromechanical Components Division
 Matsushita Electronic Components Co., Ltd

Document	Product specifications	Mark-number : 151-GT-077
Product	EPL1801S2E	36-32 Revision-number:0

8-2. Application of paper end sensor (automatic paper loading)

Automatic paper loading is capable by using the paper out sensor.

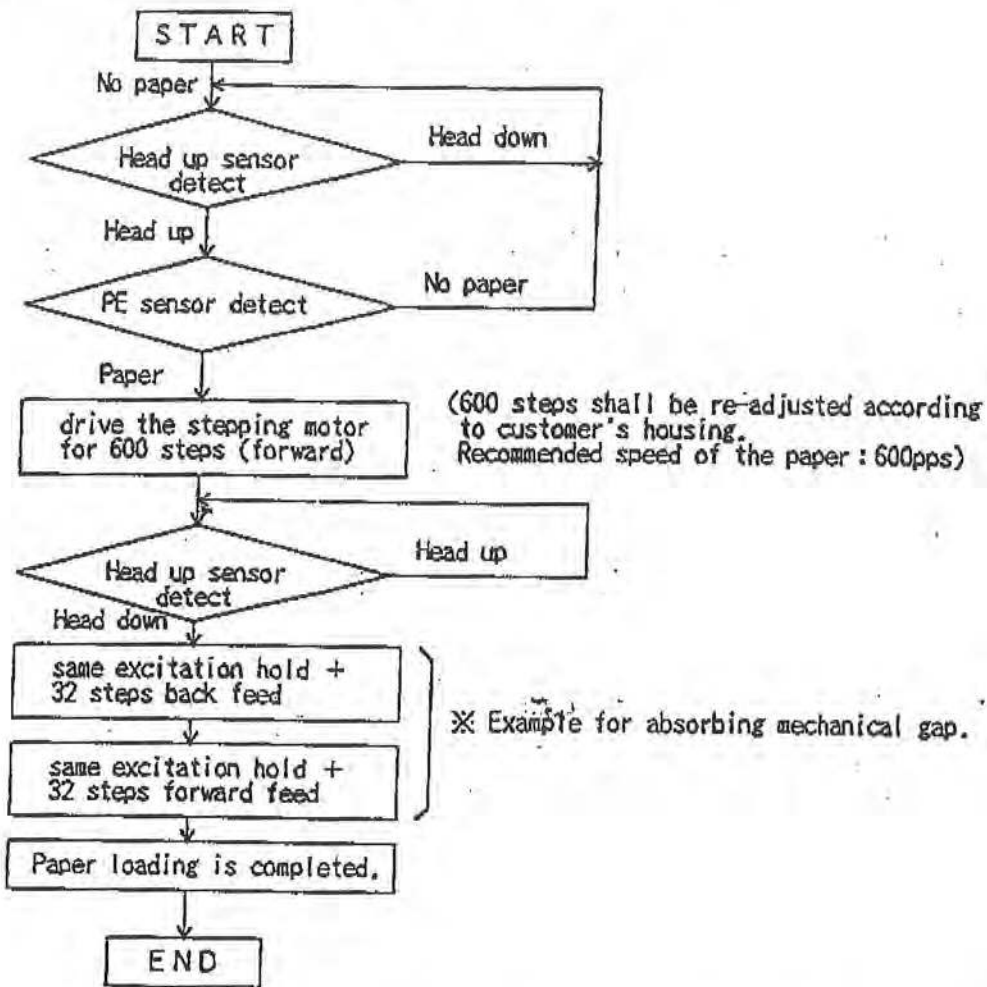

※ If recording paper is skew, drive the stepping motor until the paper becomes straight, or settle the paper by hand with the head-up state.

Note		Format No. FORM1062.JBW
Established JUL/31/97	Electronic Devices Department Electromechanical Components Division Matsushita Electronic Components Co.,Ltd	
Enforced JUL/31/97		

Document	Product specifications	Mark-number : 151-GY-077
Product	EPL1801S2E	36-33 Revision-number:0

9. Connection

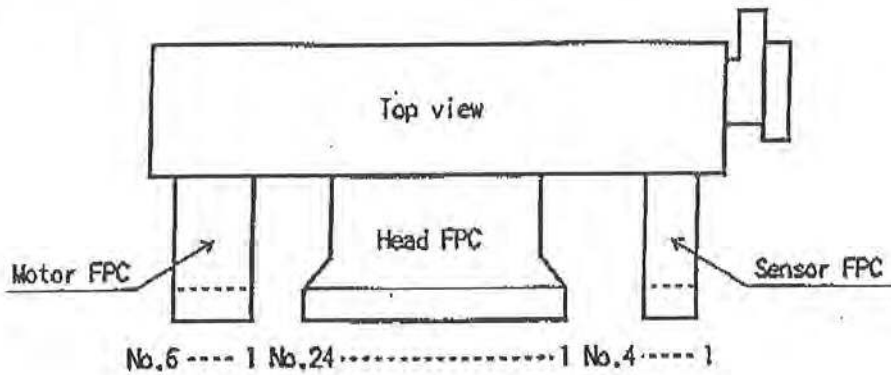

9-1. Matching connecter

	Number of terminals	Recommended connector
Head FPC	24	Molex Co. : 52207-2417(angle type, with lock type) 52610-2417(straight type, with lock type)
Motor FPC	6	Molex Co. : 52643-0610(angle type, without lock type) 52610-0617(straight type, with lock type)
Sensor FPC	4	Molex Co. : 52643-0410(angle type, without lock type) 52808-0410(straight type, without lock type)

※ Evaluate the specifications(POWER RATING, CONTACT RESISTANCE, WITHDRAWING FORCES etc.), when using un-recommended connector.

Note		Format No. FORM1062.JBW
Established JUL/31/97	Electronic Devices Department Electromechanical Components Division Matsushita Electronic Components Co.,Ltd	
Enforced JUL/31/97		

Document	Product specifications	Mark-number : 151-GT-077
Product	EPL1801S2E	36-34 Revision-number:0

9-2. Pin layout for FPC

9-2-1. Head FPC

No.	Signal name	I/O	
1	Vp	I	Supply voltage to head
2	Vp	I	Supply voltage to head
3	GND	—	GND
4	GND	—	GND
5	NC	—	No connection
6	NC	—	No connection
7	NC	—	No connection
8	DI 6	I	DATA-IN 6
9	CLK	I	CLOCK
10	LAT	I	LATCH
11	Vdd	I	Supply voltage to logic
12	STB	I	STROBE
13	TM _h	O	Thermistor (Another terminal is grounded.)
14	RANK 1	O	Head lank
15	RANK 2	O	Head lank
16	DI 5	I	DATA-IN 5
17	DI 4	I	DATA-IN 4
18	DI 3	I	DATA-IN 3
19	DI 2	I	DATA-IN 2
20	DI 1	I	DATA-IN 1
21	GND	—	GND
22	GND	—	GND
23	Vp	I	Supply voltage to head
24	Vp	I	Supply voltage to head

9-2-2. Motor FPC

No.	Signal name	
1	TM _m	Thermistor
2	TM _m	Thermistor
3	A	Motor driving signal
4	B	Motor driving signal
5	A	Motor driving signal
6	B	Motor driving signal

9-2-3. Sensor FPC

No.	Signal name	内容
1	Pan	Photo reflector (anode)
2	Pco	Photo reflector (collector)
3	GND	GND (emitter & cathode, SW)
4	Hup	SW

Note

Format No.
FORM1062.JBW

Established
JUL/31/97

Enforced
JUL/31/97

Electronic Devices Department
Electromechanical Components Division
Matsushita Electronic Components Co.,Ltd

Document	Product specifications	Mark-number : 151-GT-077
Product	EPL1801S2E	36-35 Revision-number:0

9. Timing chart of the printer

(1) The full timing (one cycle) is explained as shown below.

In case of printing, the serial printing data are input by being synchronized with the CLK signal, and the printing data are stored at the timing by the LATCH signal inputted. The stored printing data are applied power to the heating element by the STB signal.

※ Print data = "High" → ON(coloring), Print data = "Low" → OFF(not coloring)

(2) When printing, keep head down state(the mechanical switch OFF) and paper presence (the photo sensor ON).

[Operation sequence]

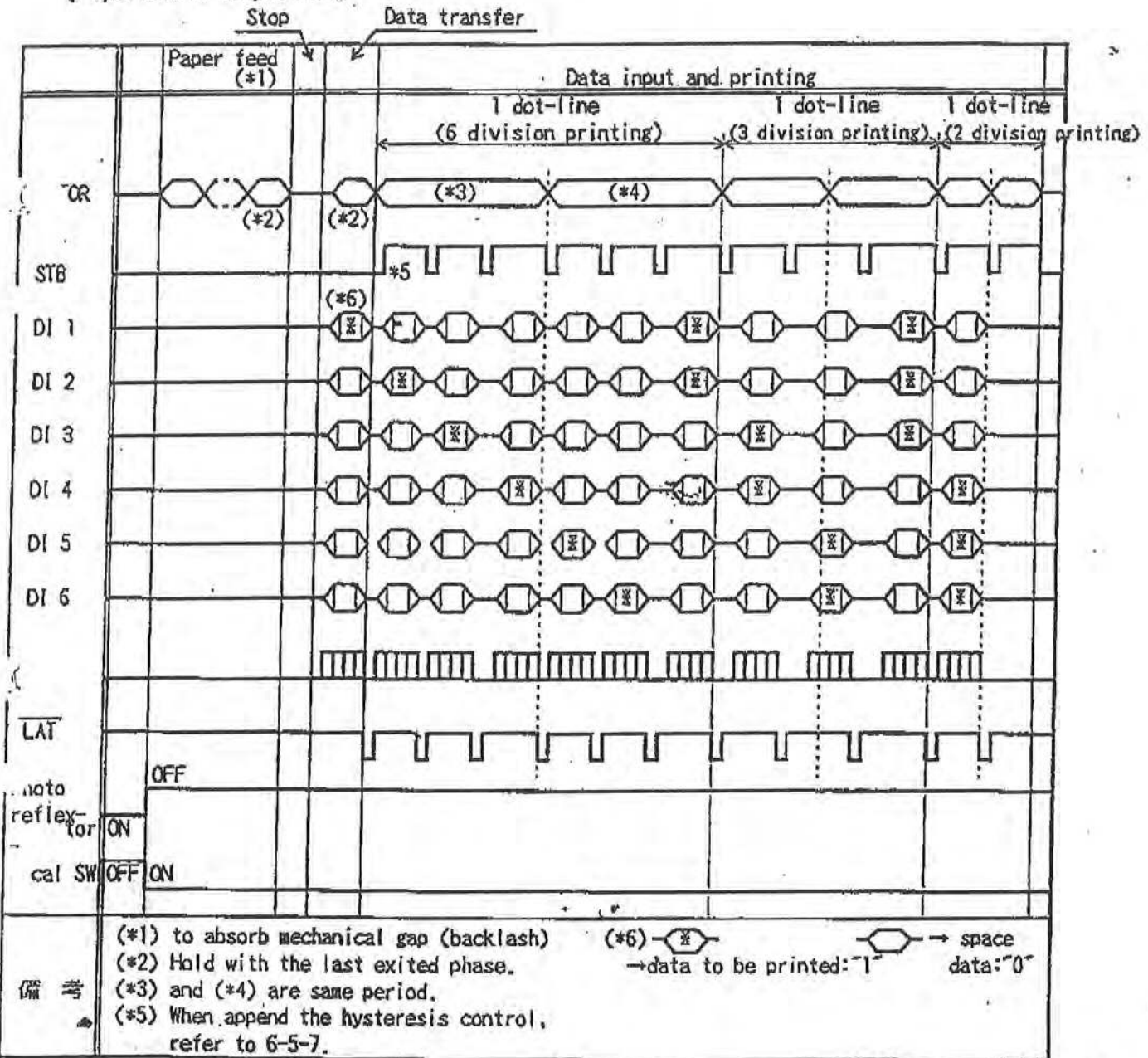

Note

Format No.
FORM1062.JBW

Established
JUL/31/97
Enforced
JUL/31/97

Electronic Devices Department
Electromechanical Components Division
Matsushita Electronic Components Co.,Ltd

