

# VIZIO



## **QUICK START GUIDE**

Model: S3820w-C0

# IMPORTANT SAFETY INSTRUCTIONS

Your Unit is designed and manufactured to operate within defined design limits, and misuse may result in electric shock or fire. To prevent your Unit from being damaged, the following rules should be observed for its installation, use, and maintenance. Please read the following safety instructions before operating your Unit. Keep these instructions in a safe place for future reference.

- Read these instructions.
- Keep these instructions.
- Heed all warnings.
- Follow all instructions.
- Do not use this apparatus near water.
- Clean only with a dry cloth.
- Do not block any ventilation openings. Install in accordance with the manufacturer's instructions.
- Do not install near any heat sources such as radiators, heat registers, stoves, or other apparatus (including amplifiers) that produce heat.
- Do not defeat the safety purpose of the polarized or grounding-type plug. A polarized plug has two blades with one wider than the other. A grounding type plug has two blades and a third grounding prong. The wide blade or the third prong are provided for your safety. If the provided plug does not fit into your outlet, consult an electrician for replacement of the obsolete outlet.
- Protect the power cord from being walked on or pinched, particularly at plugs, convenience receptacles, and the point where they exit from the apparatus.
- Only use attachments/accessories specified by the manufacturer.
- Use only with the cart, stand, tripod, bracket, or table specified by the manufacturer, or sold with the apparatus. When a cart is used, use caution when moving the cart/apparatus combination to avoid injury from tip-over.
- Unplug this apparatus during lightning storms or when unused for long periods of time.
- Refer all servicing to qualified service personnel. Servicing is required when the apparatus has been damaged in any way, such as when the power supply cord or plug is damaged, liquid has been spilled or objects have fallen into the apparatus, the apparatus has been exposed to rain or moisture, does not operate normally, or has been dropped.
- To reduce the risk of electric shock or component damage, switch off the power before connecting other components to your Unit.
- Unplug the power cord before cleaning your Unit. A damp cloth is sufficient for cleaning. Do not use a liquid or a spray cleaner on your Unit. Do not use abrasive cleaners.
- Always use the accessories recommended by the manufacturer to insure compatibility.
- When moving your Unit from an area of low temperature to an area of high temperature, condensation may form in the housing. Wait before turning on your Unit to avoid causing fire, electric shock, or component damage.
- Slots and openings in the back and bottom of the cabinet are provided for ventilation. To ensure reliable operation of your Unit and to protect it from overheating, be sure these openings are not blocked or covered. Do not place your Unit in a bookcase or cabinet unless proper ventilation is provided.
- Never push any object into the slots and openings on your Unit enclosure. Do not place any objects on the top of your Unit. Doing so could short circuit parts causing a fire or electric shock. Never spill liquids on your Unit.
- When connected to a power outlet, power is always flowing into your Unit. To totally disconnect power, unplug the power cord.



- Do not overload power strips and extension cords. Overloading can result in fire or electric shock.
- The wall socket should be located near your Unit and be easily accessible.
- Keep your Unit away from moisture. Do not expose your Unit to rain or moisture. If water penetrates into your Unit, unplug the power cord and contact your dealer. Continuous use in this case may result in fire or electric shock.
- Do not use your Unit if any abnormality occurs. If any smoke or odor becomes apparent, unplug the power cord and contact your dealer immediately. Do not try to repair your Unit yourself.
- Avoid using dropped or damaged appliances. If your Unit is dropped and the housing is damaged, the internal components may function abnormally. Unplug the power cord immediately and contact your dealer for repair. Continued use of your Unit may cause fire or electric shock.
- Do not install your Unit in an area with heavy dust or high humidity. Operating your Unit in environments with heavy dust or high humidity may cause fire or electric shock.
- Ensure that the power cord and any other cables are unplugged before moving your Unit.
- When unplugging your Unit, hold the power plug, not the cord. Pulling on the power cord may damage the wires inside the cord and cause fire or electric shock. When your Unit will not be used for an extended period of time, unplug the power cord.
- To reduce risk of electric shock, do not touch the connector with wet hands.
- Insert the remote control batteries in accordance with instructions. Incorrect polarity may cause the battery to leak which can damage the remote control or injure the operator.
- See the important note and rating located on the back of the unit.
- WARNING - This equipment is not waterproof. To prevent a fire or shock hazard, do not place any container filled with liquid near the equipment (such as a vase or flower pot) or expose it to dripping, splashing, rain, or moisture.
- CAUTION - Danger of explosion or fire if batteries are mistreated. Replace only with the same or specified type.
- Do not leave the batteries exposed to direct sunlight for a long period of time with doors and windows closed. Do not disassemble the batteries or dispose of it in fire.

**WARNING: To reduce the risk of fire or electric shock, do not expose this apparatus to rain or moisture.**



Explanation of WARNING symbols:



The lightning flash with arrowhead symbol within an equilateral triangle is intended to alert the user to the presence of not isolated dangerous voltage within the product that may be sufficient magnitude to constitute a risk of shock to persons.



The exclamation point within an equilateral triangle is intended to alert the user to the presence of important operating and servicing instructions in the literature accompanying the appliance.

# PACKAGE CONTENTS



High Definition Sound Bar



Remote Control



Power Cable

# CONTROLS & CONNECTIONS

Back of Sound Bar



**AUX (1)**  
Analog Audio In

**Power Port**

**Service Port**

**DIGITAL (3)**  
Coaxial In  
**OPTICAL (4)**  
Digital Optical Audio In  
**AUX (2)**  
Analog Audio In

**SUB OUT**  
Subwoofer Out

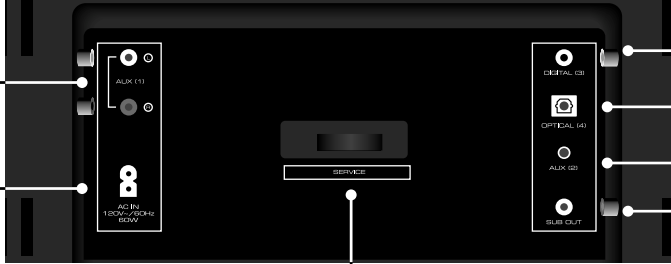

## Back of Sound Bar

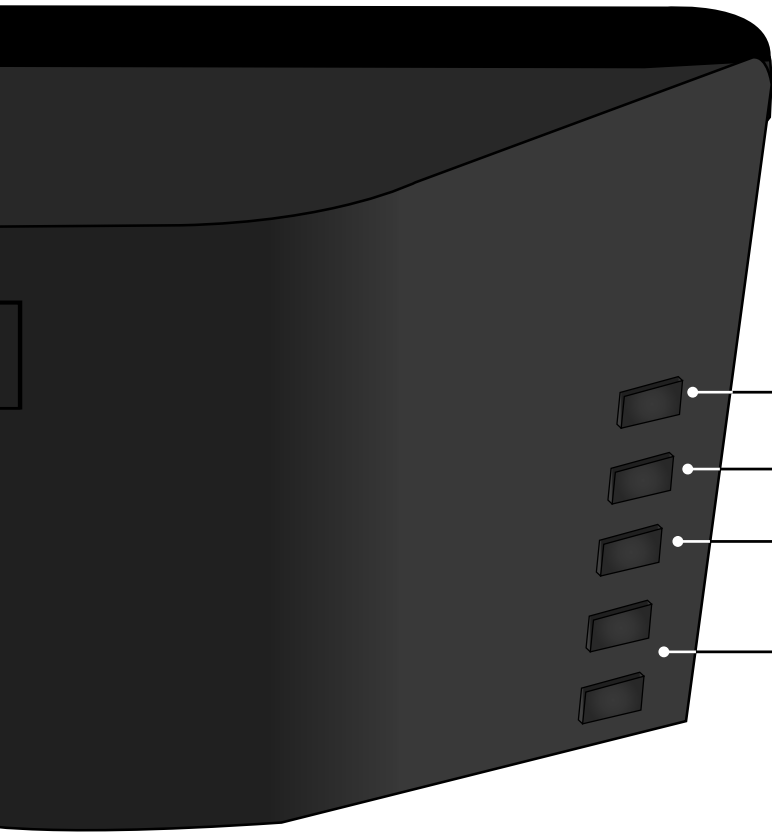

Control Buttons are located here:



**Power**



**Input**



**Bluetooth Input**

(Hold to force pair, See 'Bluetooth Pairing' for more information.)



**Volume**



# FIRST-TIME SETUP

Back of Sound Bar

1

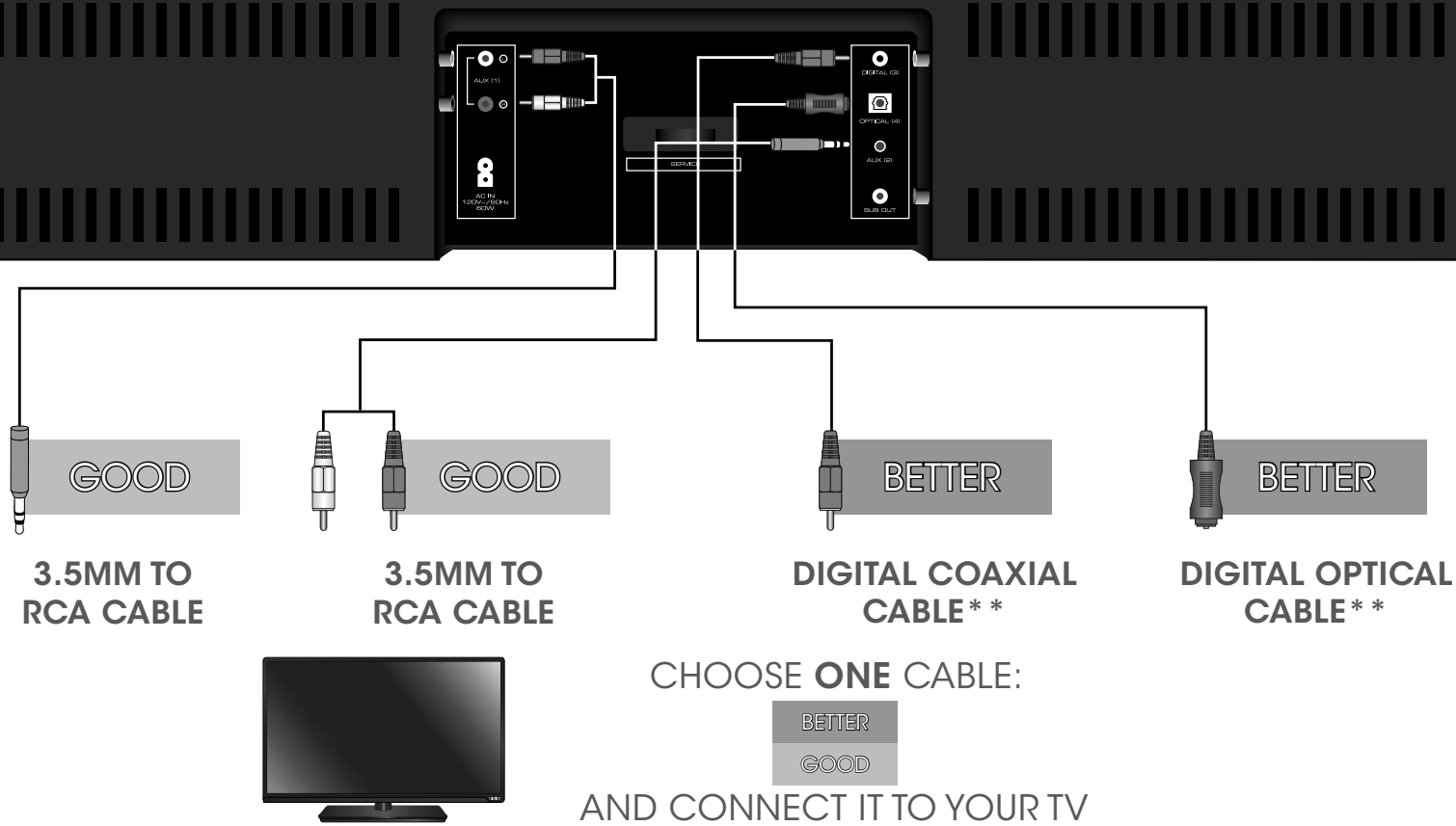

\*Not all TVs have the audio outputs shown above. To connect the Sound Bar directly to your other devices (Blu-ray player, game system, etc) see your device's user manual.

\*\*When using either of the Digital Inputs, if there is no audio: (A) try setting the TV output to PCM or (B) Connect directly to your Blu-ray/other source, some TVs do not pass through digital audio.

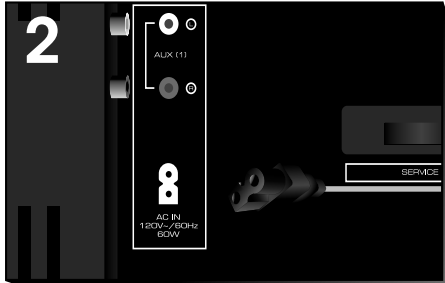

Connect the Power Cable to the Sound Bar.



Plug the Power Cable into a power outlet.

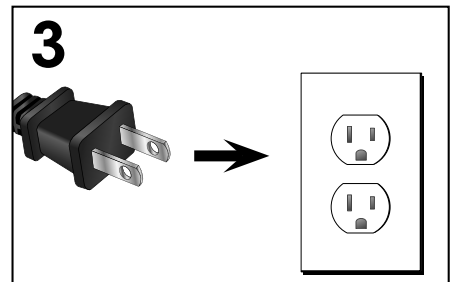

4

Sound Bar is centered  
below the TV.

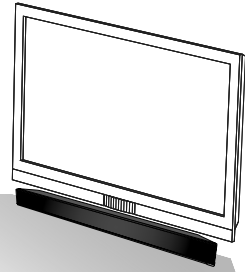

For the best surround sound experience, position the Sound Bar as shown.  
The Sound Bar should be close to ear level.



5



Remove the battery cover by gently sliding it away from the remote.

6



Insert the included batteries and gently slide the battery cover back into place.

7

Turn your TV on, then press the **Power** button on the remote to turn the Sound Bar on.

Press the **Input** button to switch between audio sources. For example, if you connected your TV to Input 1, set the Sound Bar to Input 1.

Hardware setup is complete.

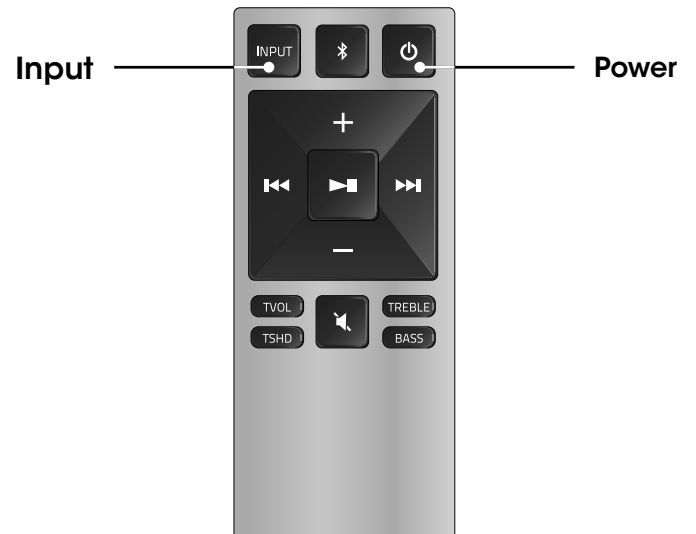

# USING THE REMOTE

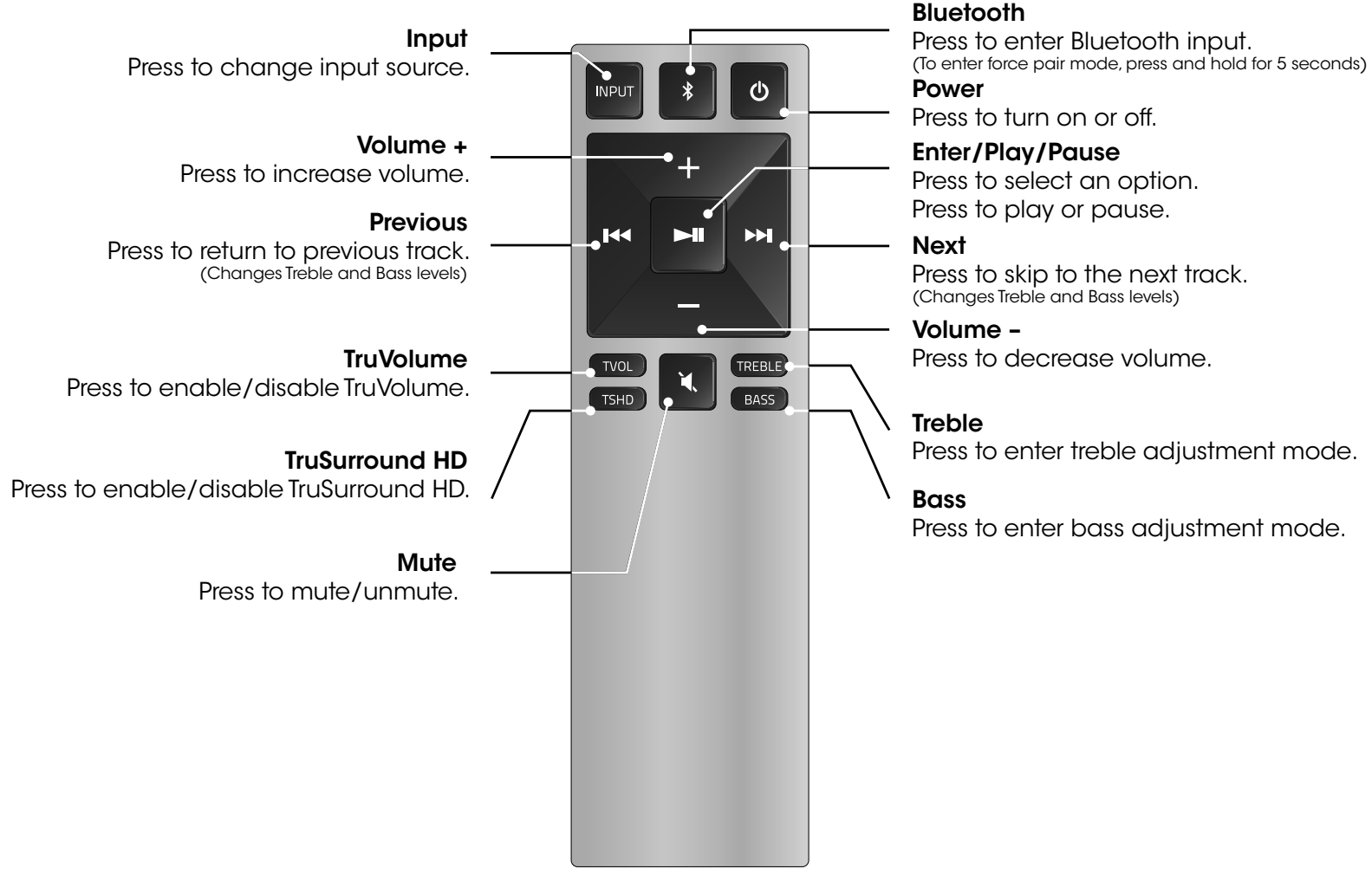



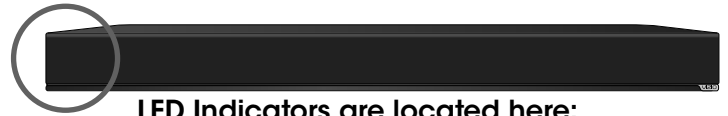





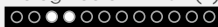
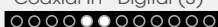

# LED INDICATORS





**LED Indicators are located here:**

The LED Indicators will behave differently with each button on the remote control.

Function	LED Behavior	Description
Input	Analog Audio In - AUX (1)  Analog Audio In - AUX (2)  Coaxial In - Digital (3)  Digital Optical Audio In - Optical (4)  Bluetooth 	Press the <b>INPUT</b> button on the remote to cycle through each available input: <ul style="list-style-type: none"> <li>Analog Audio In - AUX (1)</li> <li>Analog Audio In - AUX (2)</li> <li>Coaxial In- Digital (3)</li> <li>Digital Optical Audio In - Optical (4)</li> <li>Bluetooth</li> </ul>
Bluetooth Pairing	(When searching for device) Flash from Left to Right and back continuously. 	Press and hold the <b>⌘</b> button on the remote. The Sound Bar will be discoverable for 15 minutes. You can now search for the Sound Bar (VIZIO S3820w) using your Bluetooth Device. The sound bar will power down if no device is found. <b>Note:</b> Set your Bluetooth device into pairing mode prior to the Sound Bar.
DTS TruVolume On/Off	TruVolume On:  TruVolume Off: 	Press the <b>TVOL</b> button to enable/disable TruVolume. When enabled (On), TruVolume provides a consistent and comfortable volume level for a more enjoyable listening experience.
DTS TruSurround On/Off	TruSurround On:  TruSurround Off: 	Press the <b>TSHD</b> button to enable/disable DTS TruSurround. When enabled (On), all inputs will produce virtual surround sound. When disabled (Off), all sources will playback in stereo.
Treble Levels	Two center LEDs indicate Treble level 0. 	Press the <b>TREBLE</b> button then press the <b>Next/Previous</b> button to increase/decrease the treble level. The LED indicators will move to the right with increasing levels and to the left with decreasing levels.
Bass Levels	Two center LEDs indicate Bass level 0. 	Press the <b>BASS</b> button then press the <b>Next/Previous</b> button to increase/decrease the bass level. The LED indicators will move to the right with increasing levels and to the left with decreasing levels.
Dolby Digital	Dolby Digital Logo. 	Dolby Digital is only available on either the <b>Coaxial In</b> or <b>Digital Optical Audio In</b> inputs. When a Dolby Digital signal is detected, the Dolby Digital logo will light up for 5 seconds before fading away.

# BLUETOOTH PAIRING

To pair the Sound Bar with a Bluetooth device:

1. Press and hold the **Bluetooth** button  on the Sound Bar or the **Bluetooth** button  on the remote for five (5) seconds. When the Sound Bar is in Bluetooth Pairing Mode, the LED Indicators on the Display Panel on the front of the Sound Bar will light sequentially from left to right and back again.

Once the device is paired, the LED Indicators will stop flashing.

2. You can now search for the Sound Bar (VIZIO S3820w) using your Bluetooth device. For more information, see the documentation that came with your device.
3. Play audio from your Bluetooth device. Volume can be controlled on your source device and the Sound Bar.

## Back of Sound Bar

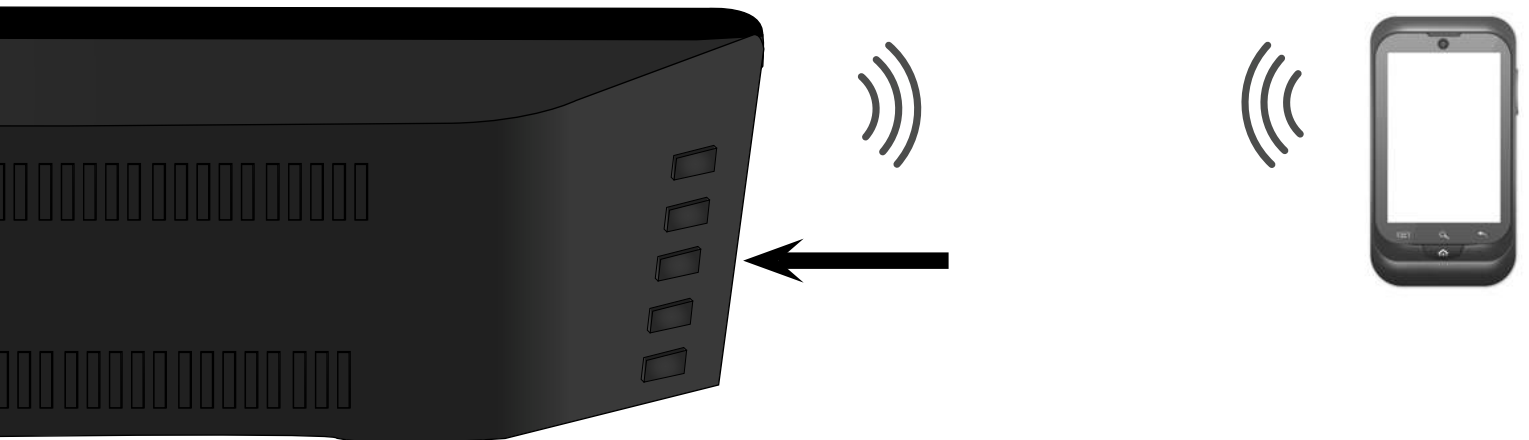

## USING BLUETOOTH MODE

Your Sound Bar supports music streaming from smartphones, tablets, and computers with Bluetooth capability. Device compatibility will vary, see your device's documentation for more information. Once you have paired your source device to the Sound Bar, as long as you stay within range of the Sound Bar, your device should remain paired, even if you change the input on the Sound Bar.



Your Sound Bar is not equipped with a microphone, so it cannot operate as a hands-free device for a smartphone.

### Maximizing Signal

A Bluetooth signal has a range of up to 30 feet. Keep in mind that Bluetooth is a compressed audio format, so streamed music may lose some integrity when compared to a wired connection.

Try the following if your sound quality is less than optimal:

- If you hear any break-up or disconnect while streaming music from your device, move the source device closer to the Sound Bar.
- Be sure that there are no solid obstructions in the line-of-sight between the Sound Bar and the source device.
- Other wireless devices can affect Bluetooth range, including wireless security cameras, wireless video baby monitors, cordless phones, and microwave ovens. Turning off or moving these devices may improve Bluetooth range.



Reduce the volume levels on your device and on the Sound Bar before pressing **Play**. High volume levels can damage your hearing.

# ADVANCED SETUP

Connect up to four (4) different devices to the Sound Bar (devices shown are examples you can use any device).

To listen to a device, change the input source on the Sound Bar.

Optical, Coaxial, and 3.5mm cables transmit audio only. If connecting a video device, you will need a separate video connection from the device to your TV.

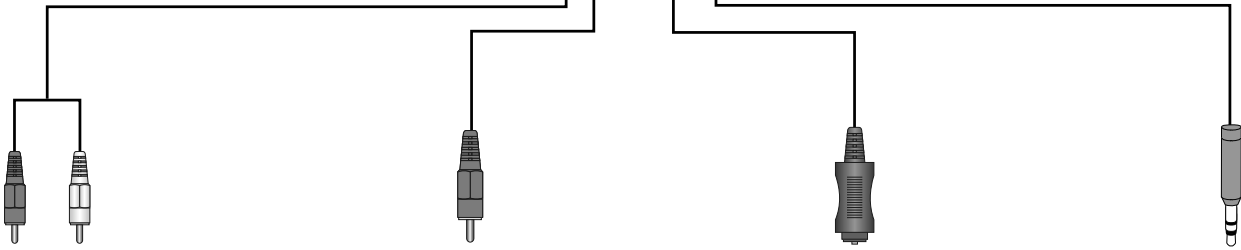
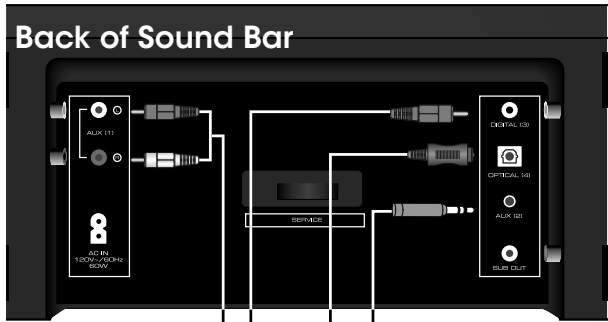

RCA AUDIO CABLE

DIGITAL COAXIAL CABLE

DIGITAL OPTICAL CABLE

3.5mm AUDIO CABLE



Game Console



Network Media Player



Tablet/MP3 Player/Laptop

# CONNECTING A SUBWOOFER

## Back of Sound Bar

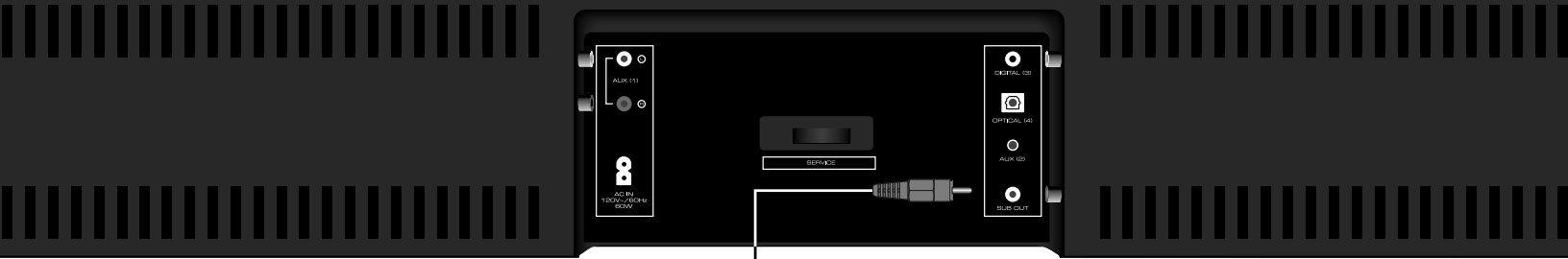

RCA Subwoofer Cable\*

Optional Subwoofer\*

For best results setting up an optional subwoofer, VIZIO suggests the following procedure:

1. Press the **BASS** button on the remote control to enter bass adjustment mode.
2. Use the **Previous/Next** buttons to adjust the bass level to the center position.
3. Power **Off** the Sound Bar and Subwoofer. Connect an RCA cable from the Sound Bar to the Subwoofer.
4. Power **On** the Sound Bar and Subwoofer.
5. Manually adjust the SUB gain (Volume) and phase to your preference. See your subwoofer's user manual for more information.
6. Use the **BASS** button on the remote control to adjust the subwoofer's output.



\*RCA subwoofer cable and subwoofer not included.

# WALL MOUNTING THE SOUND BAR

1

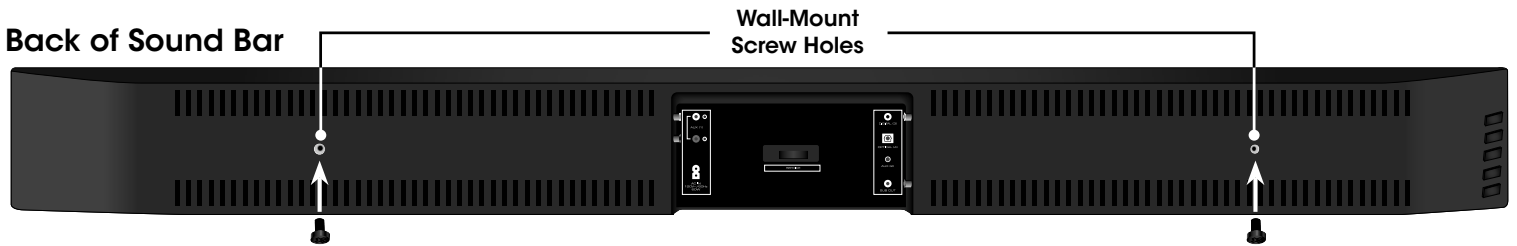

Insert and tighten two Wall-Mount Screws with a Phillips-head screwdriver into the Wall-Mount Screw Holes.

2

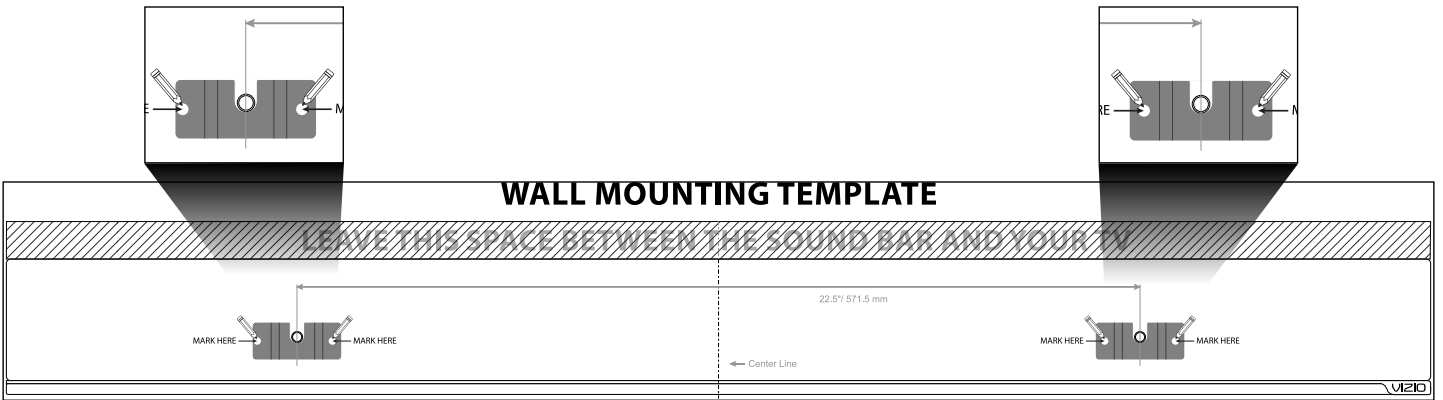

Place the included wall mounting template against the wall under your TV. Mark the four bracket holes using a pencil.



# 3



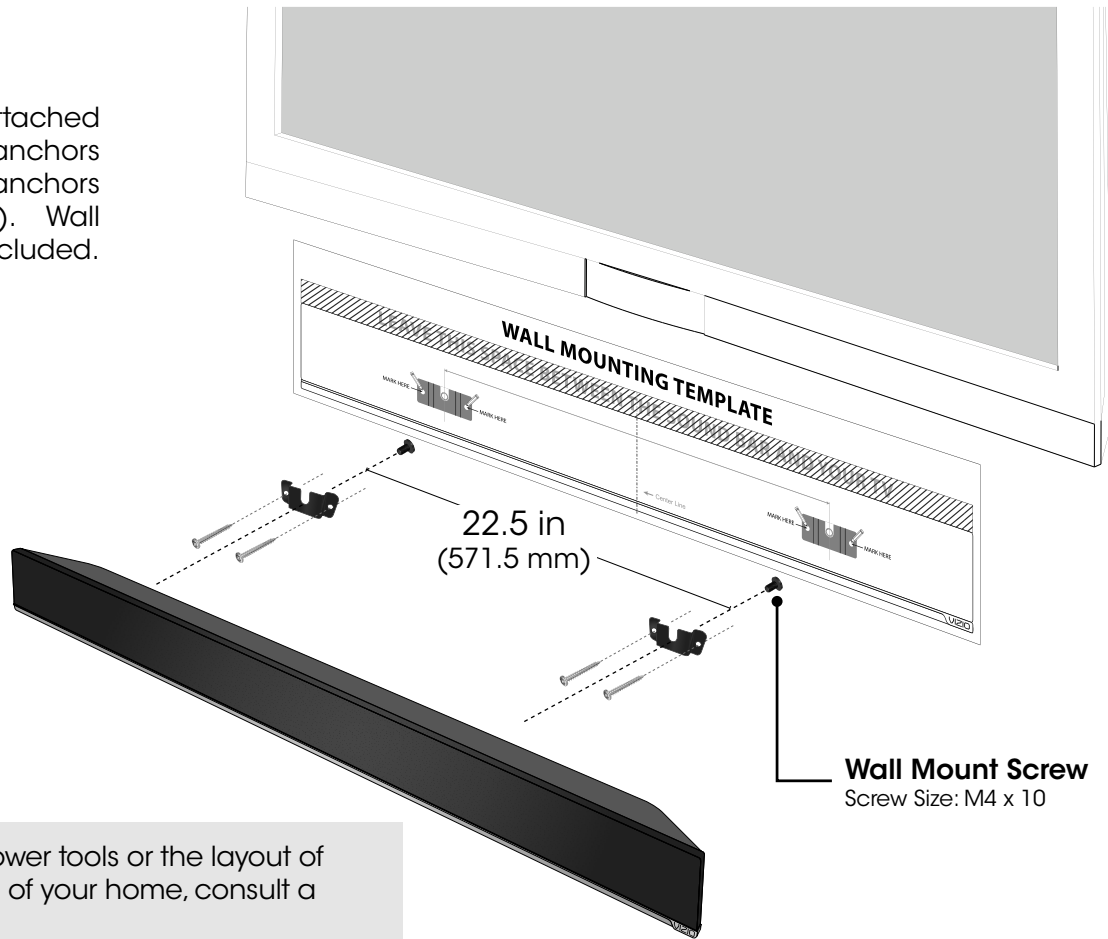

Be sure your screws are attached to wood studs or drywall anchors (for drywall) or concrete anchors (for brick/concrete walls). Wall mounting hardware is not included.



If you are unfamiliar with power tools or the layout of electrical wiring in the walls of your home, consult a professional installer.

# BUTTON CONFIGURATION

There are 3 Functions that are triggered by 3 different button combinations on the Sound Bar.

Function	LED Behavior	Description
Factory Reset	All 12 LEDs will flash 3 times: 	Reset the Sound Bar to the factory default settings. To perform a Factory Reset, <u>Press and Hold</u> the <b>Bluetooth</b> (Ⓜ) and <b>Volume Down</b> (←) buttons for <b>5 seconds</b> . <b>Note:</b> This will erase all settings and preferences that you have set.
VIZIO TV Remote Control	Enable VIZIO TV Remote:  Disable VIZIO TV Remote: 	Enable/disable the use of a VIZIO TV remote control to power on and adjust the volume of the sound bar. To enable/disable this function, <u>Press and Hold</u> the <b>Power</b> (⏻) and <b>Volume Up</b> (+) buttons for <b>5 seconds</b> .
Energy Star	Enable Energy Star:  Disable Energy Star: 	When the Energy Star setting is enabled, the sound bar will automatically power down after a period of inactivity. When disabled, the sound bar will remain powered on until you turn it off. To enable/disable this function, <u>Press and Hold</u> the <b>Power</b> (⏻) and <b>Volume Down</b> (←) buttons for <b>5 seconds</b> . <b>Note:</b> Energy Star setting is enabled by default.

## Back of Sound Bar

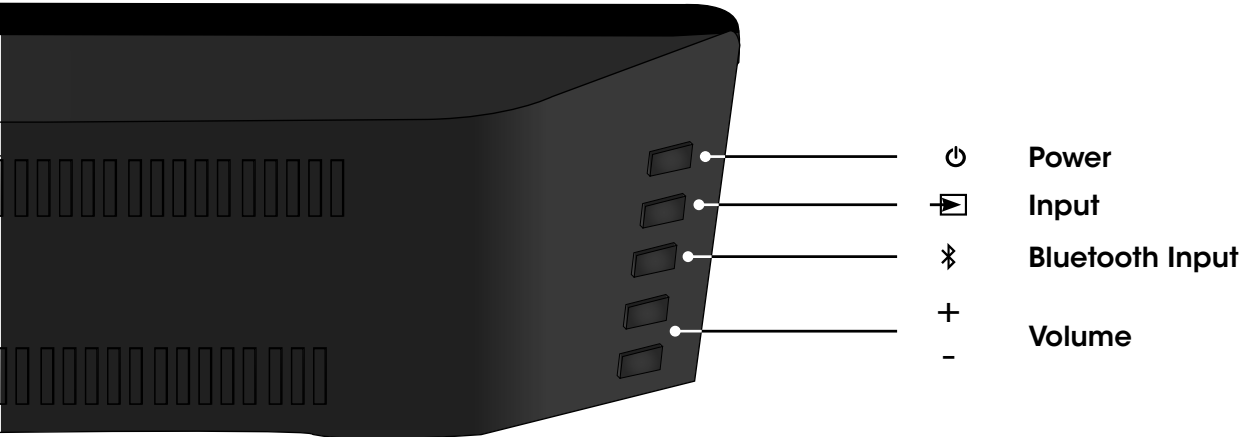

# HELP & TROUBLESHOOTING

There is no power.

- Press the **POWER** button on the remote control or on the top of your Sound Bar.
  - Ensure the power cord is securely connected.
  - Plug a different device into the electrical outlet to verify that the outlet is working correctly.
- 

There is no sound.

- Increase the volume. Press **Volume Up** on the remote control or on the top of your Sound Bar.
  - Press **MUTE** on the remote to ensure the Sound Bar is not muted.
  - Press **INPUT** on the remote or on the top of your Sound Bar to select a different input source.
  - When using either of the Digital Inputs, if there is no audio: (A) Try setting the TV output to PCM or (B) Connect directly to your Blu-ray/other source, some TVs do not pass through digital audio.
  - On digital inputs, the input LEDs will flash rapidly if an unsupported format is present. Set the source to output PCM.
  - Your TV may be set to variable audio output. Confirm that the audio output setting is set to FIXED or STANDARD, not VARIABLE. Consult your TV's user manual for more detailed information.
  - If using Bluetooth, ensure that the volume on your source device is turned up and that the device is not muted.
- 

I hear buzzing or humming.

- Ensure all cables and wires are securely connected.
  - Connect a different source device (TV, Blu-ray player, etc) to see if the buzzing persists. If it does not, the problem may be with the original device.
  - Connect your device to a different input on the Sound Bar.
- 

The remote isn't working.

- Replace the remote batteries with new ones.
- Point the remote directly at the center of the Sound Bar when pressing a button.
- If using a Bluetooth connection, some of the buttons on the remote may not be supported by the streaming application. (e.g., Pandora doesn't support the Back button.)

# SPECIFICATIONS

**Sound Bar:** Two 3" High-Efficiency Full-Range Transducers  
Two 2" x 4" Bass Radiators

**Inputs:** One 3.5mm Stereo Audio  
One RCA Stereo Audio  
One Optical (Toslink)  
One Digital Coaxial Audio  
Bluetooth (Wireless)

**Sound Pressure Level (System):** 98 dB

**Frequency Response (System):** 70 Hz - 19 KHz

**Voltage:** 230 VAC, 50 Hz

# LEGAL & COMPLIANCE

## FCC Class B Radio Interference Statement

NOTE: This equipment has been tested and found to comply with the limits for a Class B digital device, pursuant to Part 15 of the FCC Rules. These limits are designed to provide reasonable protection against harmful interference in a residential installation. This equipment generates, uses and can radiate radio frequency energy, and if not installed and used in accordance with the instructions, may cause harmful interference to radio communications. However, there is no guarantee that interference will not occur in a particular installation. If this equipment does cause harmful interference to radio or television reception, which can be determined by turning the equipment off and on, the user is encouraged to try to correct the interference by one or more of the following measures:

1. Reorient or relocate the receiving antenna.
2. Increase the separation between the equipment and receiver.
3. Connect the equipment into an outlet on a circuit different from that to which the receiver is connected.
4. Consult the dealer or an experienced radio/TV technician for help.

This device complies with Part 15 of the FCC Rules. Operation is subject to the following two conditions: (1) this device may not cause harmful interference, and (2) this device must accept any interference received, including interference that may cause undesired operation.

### Notice:

1. The changes or modifications not expressly approved by the party responsible for compliance could void the user's authority to operate the equipment.
2. Shielded interface cables and AC power cord, if any, must be used in order to comply with the emission limits.
3. The manufacturer is not responsible for any radio or TV interference caused by unauthorized modification to this equipment. It is the responsibilities of the user to correct such interference.

## RF Exposure Information

This device meets the government's requirements for exposure to radio waves. This device is designed and manufactured not to exceed the emission limits for exposure to radio frequency (RF) energy set by the Federal Communications Commission of the U.S. Government. This device complies with FCC radiation exposure limits set forth for an uncontrolled environment.

## IC Statement

Operation is subject to the following two conditions:

1. This device may not cause interference, and
2. This device must accept any interference, including interference that may cause undesired operation of the device.

## IC Radiation Exposure Statement

This equipment complies with IC RSS-102 radiation exposure limits set forth for an uncontrolled environment. This equipment should be installed and operated with minimum distance 20cm between the radiator & your body.

## Disposal and Recycling

You must dispose of this product properly, according to local laws and regulations. Because this product contains electronic components and a battery, it must be disposed of separately from household waste. Contact local authorities to learn about disposal and recycling options.

## Other:

Image(s) used under license from Shutterstock.com



Manufactured under license from Dolby Laboratories. Dolby and the double-D symbol are trademarks of Dolby Laboratories.



For DTS patents, see <http://patents.dts.com>. Manufactured under license from DTS Licensing Limited. DTS, the Symbol, & DTS and the Symbol together are registered trademarks, and DTS TruSurround is a trademark of DTS, Inc. DTS, Inc. All Rights Reserved.



For DTS patents, see <http://patents.dts.com>. Manufactured under license from DTS Licensing Limited. DTS, the Symbol, & DTS and the Symbol together are registered trademarks, and DTS TruVolume is a trademark of DTS, Inc. © DTS, Inc. All Rights Reserved.



This product qualifies for ENERGY STAR in the "factory default" setting and this is the setting in which power savings will be achieved. Changing the factory default settings or enabling other features will increase power consumption that could exceed the limits necessary to qualify for ENERGY STAR rating.

We want to help you save energy.

