

For FAQs and more information, please visit:
anker.com/support

ANKER SOLIX



@anker_official
@anker_jp



@AnkerDeutschland
@AnkerJapan
@Anker



@AnkerOfficial
@Anker_JP

For tutorial videos, FAQs, manuals, and more information,
please visit: <https://support.anker.com>
Or scan the QR code below:



Anker 522 Portable Power Station
USER MANUAL

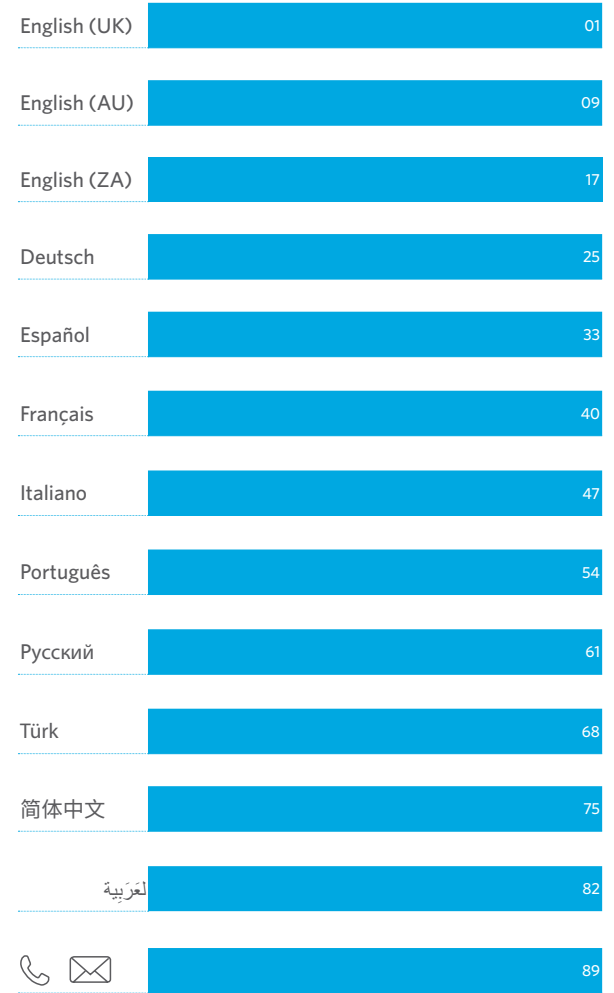

Overview

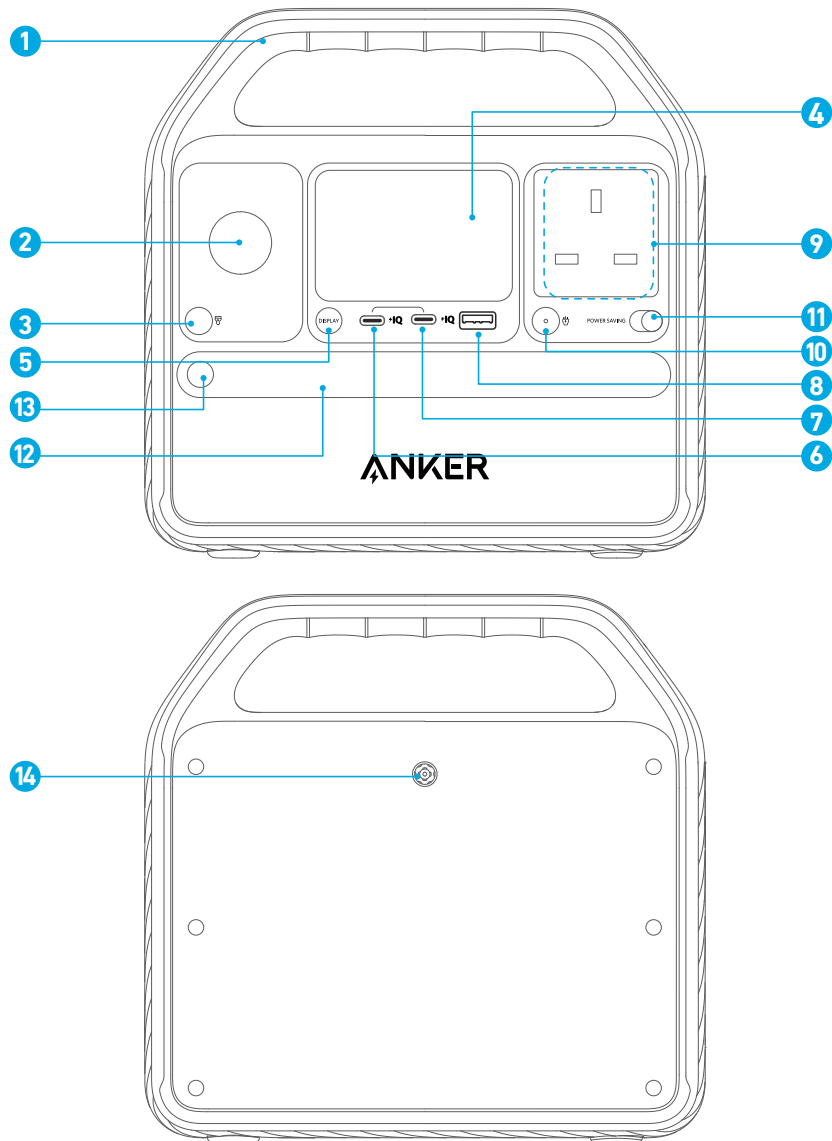

- | | |
|------------------------------------|---------------------------------|
| 1 Handle | 2 Car Socket |
| 3 Car Socket On/Off Button | 4 LCD Screen |
| 5 LCD Screen On/Off Button | 6 USB-C Input/Output Port |
| 7 USB-C Output Port | 8 USB-A Output Port |
| 9 AC Output Port | 10 AC Output Port On/Off Button |
| 11 Power Saving Mode On/Off Switch | 12 Ambient Light |
| 13 Ambient Light On/Off Button | 14 DC Input Port |

Recharging Your Power Station

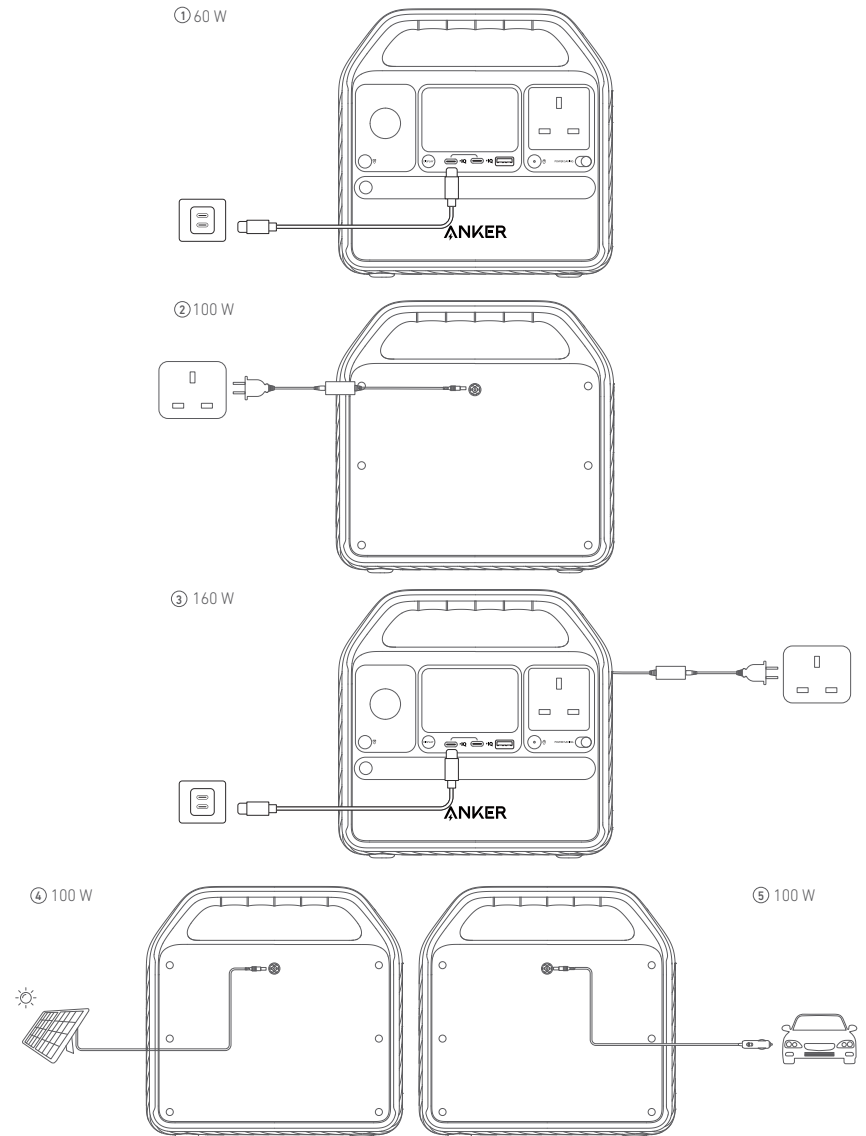

- Please fully charge the product before using it for the first time.
- When your portable power station only has 1% battery remaining, the indicators will flicker to remind you to recharge the device.

Powering Your Devices

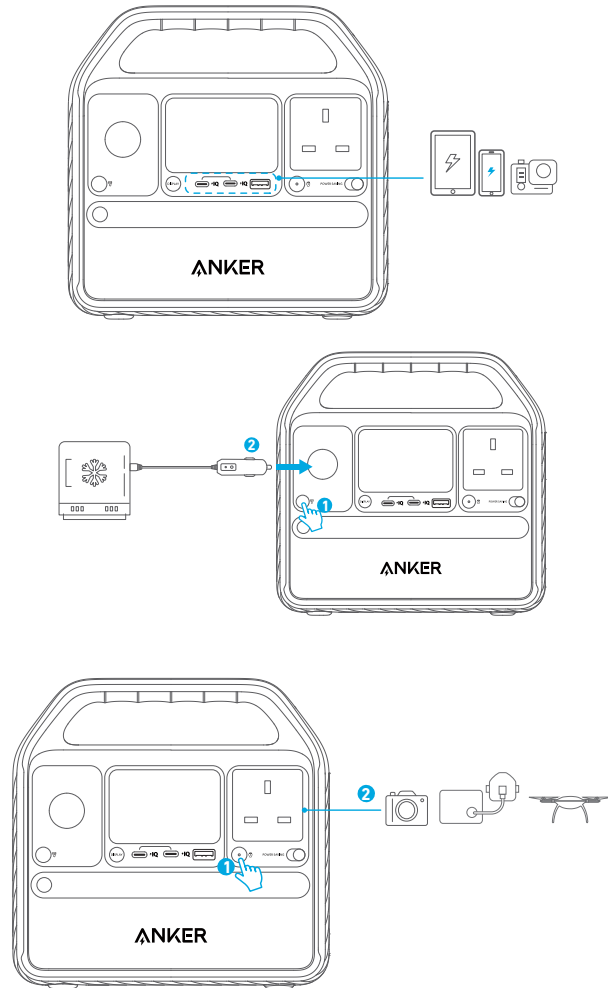

1. The USB-A and USB-C ports support plug and charge. When devices are plugged in, they will start charging automatically; when devices are unplugged, they will turn off automatically.
2. The car socket and AC output port do not support plug and charge. Use the corresponding on/off buttons to turn them on before charging.
3. To avoid draining the battery, we recommend keeping Power Saving Mode turned on except when you are charging low-powered devices like CPAP machines and cameras.

Power Saving Mode

Switching on the power saving mode prevents wasting power by automatically turning off the Power Station once all your devices are fully charged. Switching off the power saving mode will enable stable charging over an extended period, such as for time-lapse photography or for sleeping with a CPAP machine.

LCD Screen Guide

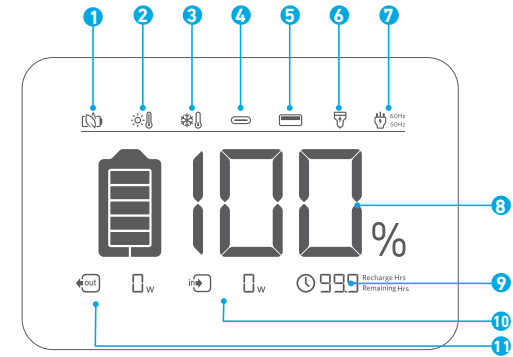

- 1 Power Saving Mode
- 2 High-Temperature Alert
 - When this icon shows, stop using the product and leave it to cool down until the icon disappears.
- 3 Low-Temperature Alert
 - When this icon shows, stop using the product until the icon disappears.
- 4 USB-C Input/Output Port
- 5 USB-A Output
- 6 Car Charging
- 7 60Hz
50Hz
AC Charging and Voltage Frequency
- 8 100%
Remaining Battery
- 9 999 Recharge Hrs
Remaining Hrs
Remaining Battery in Hours
- 10 in W
Current Input Power
- 11 out W
Current Output Power

Flashlight Mode

Press the button once to turn on the ambient light.

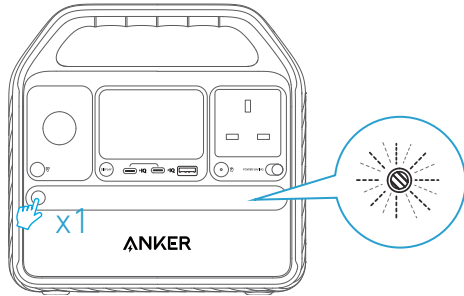

Hold the button for 2 seconds to turn on SOS mode.

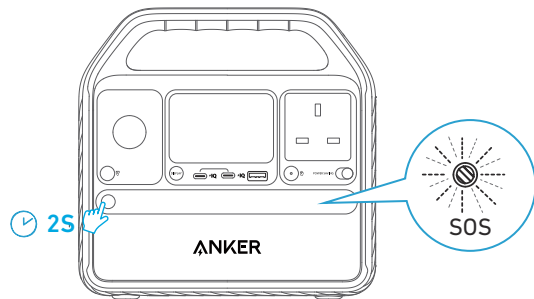

Trouble Shooting

Resetting Your Power Station

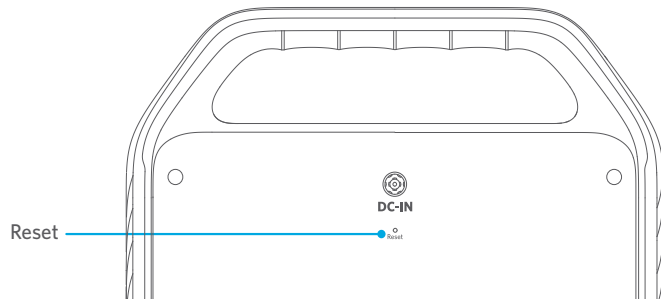

If your Power Station isn't working correctly, insert a paper clip or pin into the reset hole for 1 second for a factory reset. If the Power Station still doesn't work, please contact support@anker.com.

FAQ

Q1: What's the max power output of the AC port?

300W, and if you use the AC port for devices greater than 300W, the product will automatically turn off.

Q2: Can I recharge the product while charging connected devices?

Yes.

Q3: Can this product power a CPAP?

Yes, but do not forget to turn off the Power Saving Mode first.

Q4: Will this product lose power automatically if not powered off?

Yes, when the car socket or AC control button is turned on, even if no devices are being charged, there will still be a certain amount of no-load power consumption. To avoid draining the battery, we recommend keeping Power Saving Mode turned on except when you are charging low-powered devices like CPAP machines and cameras.

Q5: What kind of solar charger can charge this product?

Any 11V-28V solar charger with a DC 8mm (DC 7909) male connector.

Specifications

Cell Capacity	320 Wh
DC Input	11-28V $\overline{\text{---}}$ 9A (100W Max)
Car Charger Output	12V $\overline{\text{---}}$ 10A
AC Output	230V-,1.3A Max, 50Hz, 300W Max
USB-A Output	5V $\overline{\text{---}}$ 2.4A (12W Max)
USB-C 1 Input	5V $\overline{\text{---}}$ 3A/ 9V $\overline{\text{---}}$ 3A/ 15V $\overline{\text{---}}$ 3A/20V $\overline{\text{---}}$ 3A (60W Max)
USB-C 1 Output	5V $\overline{\text{---}}$ 3A/ 9V $\overline{\text{---}}$ 3A/ 15V $\overline{\text{---}}$ 3A/20V $\overline{\text{---}}$ 3A (60W Max)
USB-C 2 Output	5V $\overline{\text{---}}$ 3A/ 9V $\overline{\text{---}}$ 2.25A (20W Max)
Discharging Temperature	-4°F-104°F / -20°C-40°C
Charging Temperature	32°F-104°F / 0°C-40°C
Size	21.6*21.14*14.4cm/ 8.5*8.32*5.67inches
Net Weight	3.9kg/8.6lbs

Attention



Not permitted on aircraft.

IMPORTANT SAFETY INSTRUCTIONS

WARNING - When using this product, basic precautions should always be followed, including the following: Read all the instructions before using the product.

- To reduce the risk of injury, close supervision is necessary when the product is used near children.
 - Do not put fingers or hands into the product.
 - Do not expose the product to rain or snow.
 - Use of a power supply or charger not recommended or sold by the product manufacturer may result in a risk of fire or injury to persons.
 - To reduce risk of damage to the electric plug and cord, pull the plug rather than the cord when disconnecting the product.
 - Do not use the product in excess of its output rating. Overload outputs above rating may result in a risk of fire or injury to persons.
 - Do not use the product that is damaged or modified. Damaged or modified batteries may exhibit unpredictable behavior resulting in fire, explosion or risk of injury.
 - Do not operate the product with a damaged cord or plug, or a damaged output cable.
 - Do not disassemble the product. Take it to a qualified service person when service or repair is required. Incorrect reassembly may result in a risk of fire or electric shock.
 - Do not expose to fire or high temperatures. Exposure to fire or temperatures above 265 °F may cause explosion.
 - To reduce the risk of electric shock, unplug the power pack from the outlet before attempting any instructed servicing.
 - Have servicing performed by a qualified repair person using only identical replacement parts. This will ensure that the safety of the product is maintained.
 - When charging a device, the product may feel warm, this is a normal operating condition and should not be cause for concern.
 - When charging the internal battery, work in a well ventilated area and do not restrict ventilation in any way.
 - Do not clean the product with harmful chemicals or detergents.
 - Misuse, dropping or excessive force may cause product damage.
 - When disposing of secondary cells or batteries, keep cells or batteries of different electrochemical systems separate from each other.
- CAUTION:** Risk of explosion if the battery is replaced by an incorrect type.
- Disposal of a battery into fire or a hot oven, or mechanically crushing or cutting of a battery, can result in an explosion;
 - Leaving a battery in an extremely high temperature environment can result in an explosion or leakage of flammable liquid or gas;
 - A battery subjected to extremely low air pressure may cause an explosion or leakage of flammable liquid or gas;
 - Unplug the AC power cable to disconnect from line voltage.

Storage and Maintenance instructions

1. Store the product between 32°F-104°F (0°C-40°C). Avoid exposing the product to rain or using the product in a humid environment.
2. To preserve the battery lifespan, charge to 100% after using. If you plan to store your power station, recharge to 100% every 3 months.
3. Keep the product on a flat surface when using, charging, and storing.

FCC Statement

This device complies with Part 15 of the FCC Rules. Operation is subject to the following two conditions: (1) This device may not cause harmful interference, and (2) this device must accept any interference received, including interference that may cause undesired operation.

Warning: Changes or modifications not expressly approved by the party responsible for compliance could void the user's authority to operate the equipment.

Note: This equipment has been tested and found to comply with the limits for a Class B digital device, pursuant to Part 15 of the FCC Rules. These limits are designed to provide reasonable protection against harmful interference in a residential installation.

This equipment generates, uses, and can radiate radio frequency energy and, if not installed and used in accordance with the instructions, may cause harmful interference to radio communications. However, there is no guarantee that interference will not occur in a particular installation. If this equipment does cause harmful interference to radio or television reception, which can be determined by turning the equipment off and on, the user is encouraged to try to correct the interference by one or more of the following measures:

- (1) Reorient or relocate the receiving antenna.
- (2) Increase the separation between the equipment and receiver.
- (3) Connect the equipment into an outlet on a circuit different from that to which the receiver is connected.
- (4) Consult the dealer or an experienced radio / TV technician for help.

The following importer is the responsible party.

Company Name: Fantasia Trading LLC

Address: 5350 Ontario Mills Pkwy, Suite 100, Ontario, CA 91764

Telephone: +1-800-988-7973

IC Statement

This device complies with Industry Canada license-ICES-003. Operation is subject to the following two conditions: (1) This device may not cause interference, and (2) This device must accept any interference, including interference that may cause undesired operation of the device.

L'exploitation est autorisée aux deux conditions suivantes : (1) l'appareil ne doit pas produire de brouillage, et (2) l'utilisateur de l'appareil doit accepter tout brouillage radioélectrique subi, même si le brouillage est susceptible d'en compromettre le fonctionnement.

This digital apparatus complies with CAN ICES-003(B)/NMB-003(B).

Declaration of Conformity

Hereby, Anker Innovations Limited declares that the product type A1721 is in compliance with Directives 2014/35/EU & 2014/30/EU & 2011/65/EU. The full text of the EU declaration of conformity is available at the following internet address:

<https://www.anker.com>

GB Declaration of Conformity

Hereby, Anker Innovations Limited declares that the product type A1721 is in compliance with Electrical Equipment (Safety) Regulations 2016 & Electromagnetic Compatibility Regulations 2016 & The Restriction of the Use of Certain Hazardous Substances in Electrical and Electronic Equipment Regulations 2012. The full text of the GB declaration of conformity is available at the following internet address:

<https://www.anker.com>.

Anker Innovations Limited | Room 1318-19, Hollywood Plaza, 610 Nathan Road, Mongkok, Kowloon, HongKong
The following importer is the responsible party (contract for EU and UK matters)

Anker Innovations Deutschland GmbH | Georg-Muche-Strasse 3, 80807 Munich, Germany

Anker Technology (UK) Limited | GNR8, 49 Clarendon Road, Watford, Hertfordshire, WD17 1HP, United Kingdom



This symbol indicates that this product shall not be treated as household waste. Instead it shall be handed over to the applicable collection point for the recycling of electrical and electronic equipment.

Overview

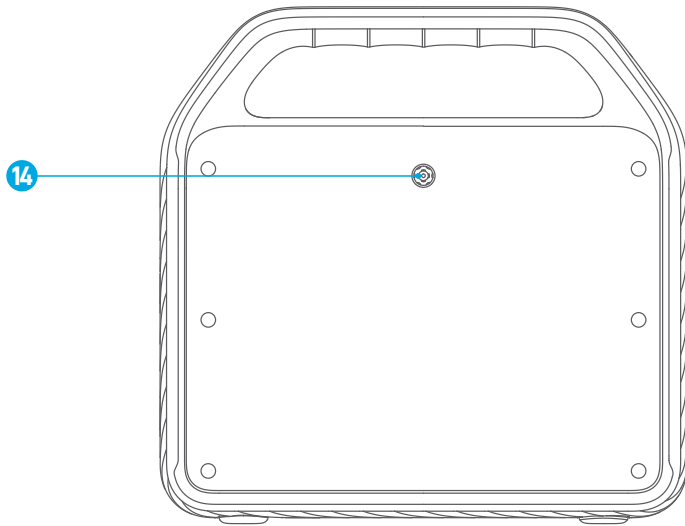
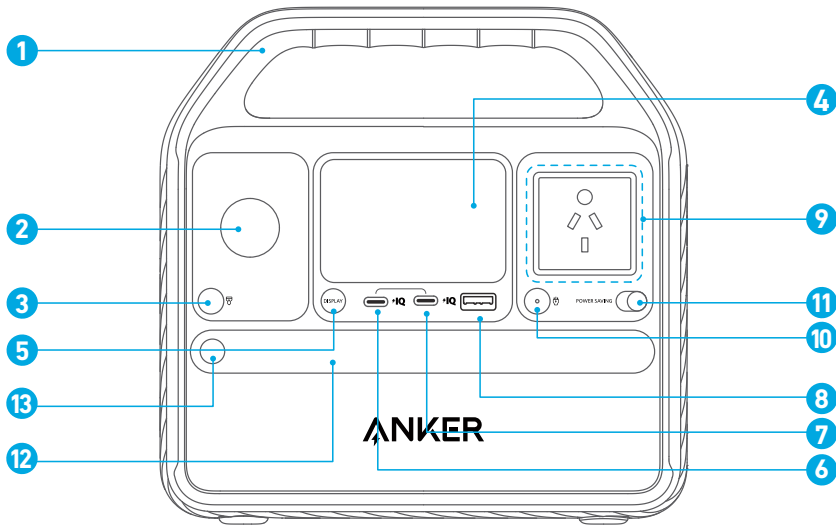

- | | |
|------------------------------------|---------------------------------|
| 1 Handle | 2 Car Socket |
| 3 Car Socket On/Off Button | 4 LCD Screen |
| 5 LCD Screen On/Off Button | 6 USB-C Input/Output Port |
| 7 USB-C Output Port | 8 USB-A Output Port |
| 9 AC Output Port | 10 AC Output Port On/Off Button |
| 11 Power Saving Mode On/Off Switch | 12 Ambient Light |
| 13 Ambient Light On/Off Button | 14 DC Input Port |

Recharging

① 60 W

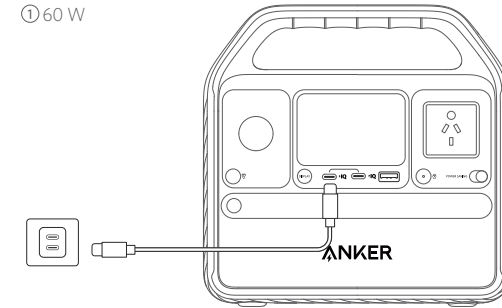

② 100 W

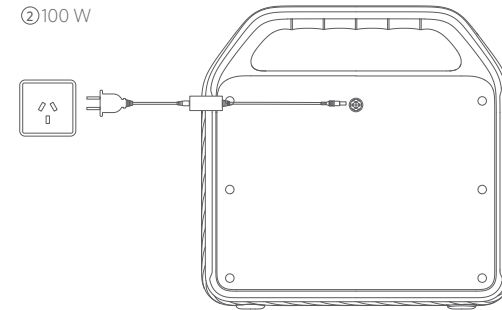

③ 160 W

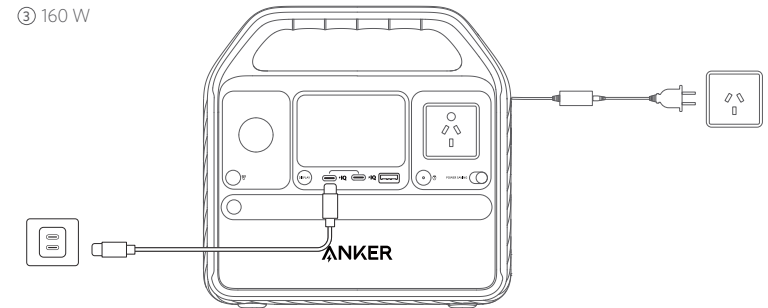

④ 100 W

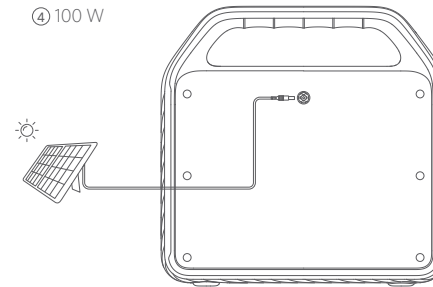

⑤ 100 W

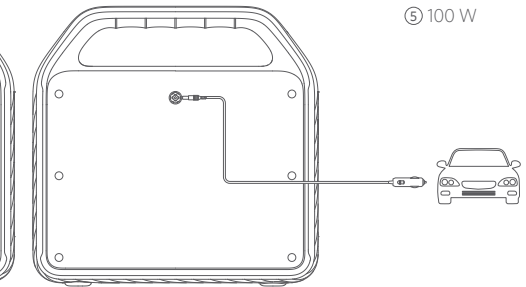

- Please fully charge the product before using it for the first time.
- When your portable power station only has 1% battery remaining, the indicators will flicker to remind you to recharge the device.

Charging

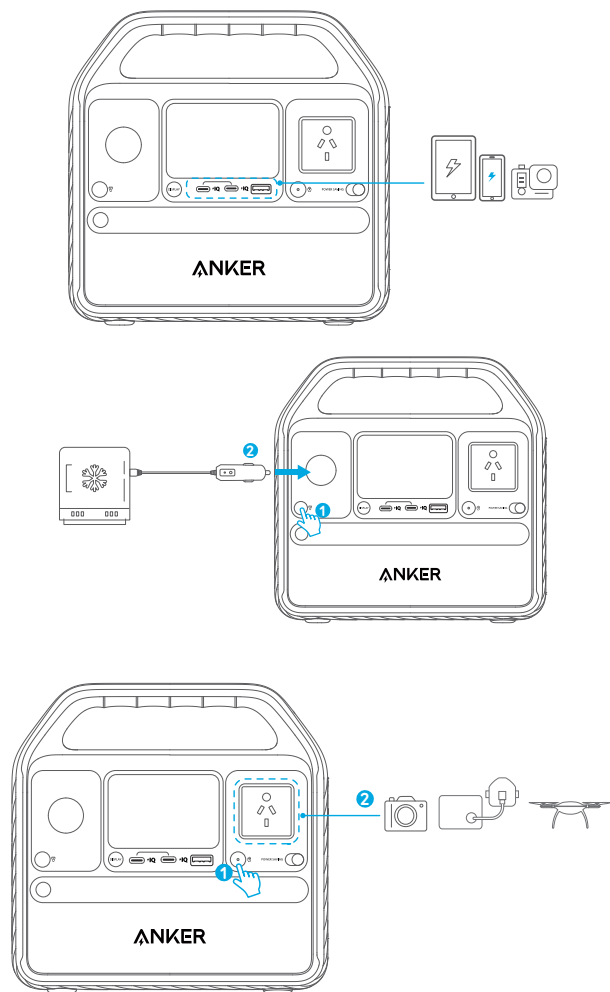

1. The USB-A and USB-C ports support plug and charge. When devices are plugged in, they will start charging automatically; when devices are unplugged, they will turn off automatically.
2. The car socket and AC output port do not support plug and charge. Use the corresponding on/off buttons to turn them on before charging.
3. To avoid draining the battery, we recommend keeping Power Saving Mode turned on except when you are charging low-powered devices like CPAP machines and cameras.

Power Saving Mode

Switching on the power saving mode prevents wasting power by automatically turning off the Power Station once all your devices are fully charged. Switching off the power saving mode will enable stable charging over an extended period, such as for time-lapse photography or for sleeping with a CPAP machine.

LCD Screen Guide

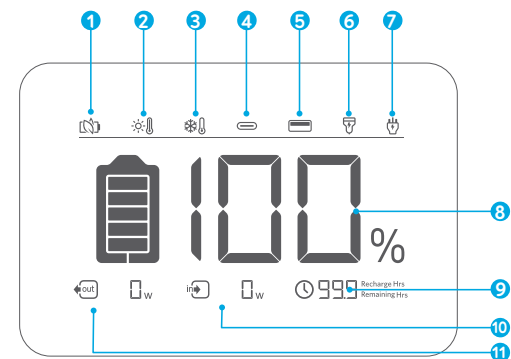

1  Power Saving Mode

2  High-Temperature Alert
 • When this icon shows, stop using the product and leave it to cool down until the icon disappears.

3  Low-Temperature Alert
 • When this icon shows, stop using the product until the icon disappears.

4  USB-C Input/Output Port

5  USB-A Output

6  Car Charging

7  AC Charging

8  Remaining Battery

9  Remaining Battery in Hours

10  Current Input Power

11  Current Output Power

Flashlight Mode

Press the button once to turn on the ambient light.

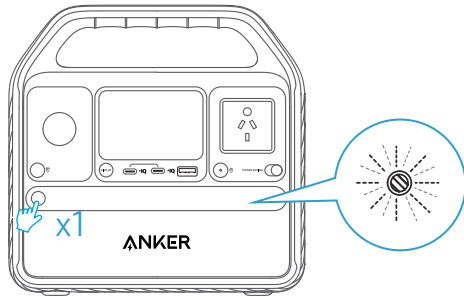

Hold the button for 2 seconds to turn on SOS mode.

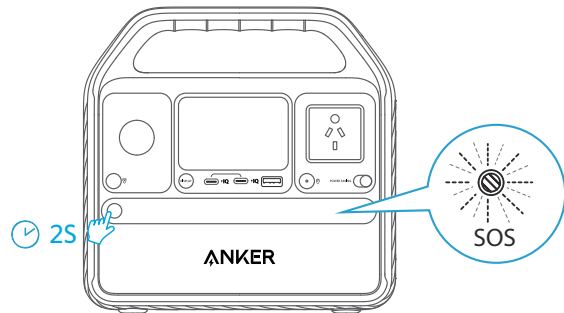

Trouble Shooting

Resetting Your Power Station

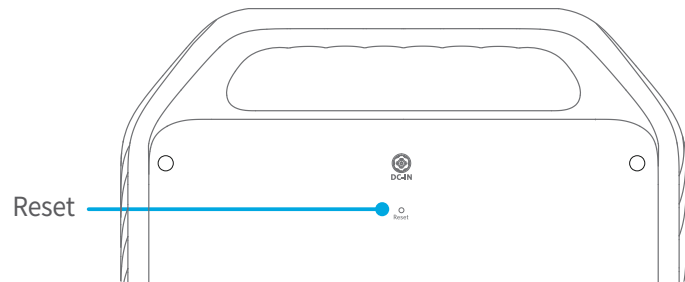

If your Power Station isn't working correctly, insert a paper clip or pin into the reset hole for 1 second for a factory reset. If the Power Station still doesn't work, please contact support@anker.com.

FAQ

Q1: What's the max power output of the AC port?

300W, and if you use the AC port for devices greater than 300W, the product will automatically turn off.

Q2: Can I recharge the product while charging connected devices?

Yes.

Q3: Can this product power a CPAP?

Yes, but do not forget to turn off the Power Saving Mode first.

Q4: Will this product lose power automatically if not powered off?

Yes, when the car socket or AC control button is turned on, even if no devices are being charged, there will still be a certain amount of no-load power consumption. To avoid draining the battery, we recommend keeping Power Saving Mode turned on except when you are charging low-powered devices like CPAP machines and cameras.

Q5: What kind of solar charger can charge this product?

Any 11V-28V solar charger with a DC 8mm (DC 7909) male connector.

Specifications

Cell Capacity	320 Wh
DC Input	11-28V $\overline{\text{---}}$ 9A (100W Max)
Car Charger Output	12V $\overline{\text{---}}$ 10A
AC Output	230V-,1.3A Max, 50Hz, 300W Max
USB-A Output	5V $\overline{\text{---}}$ 2.4A (12W Max)
USB-C 1 Input	5V $\overline{\text{---}}$ 3A/ 9V $\overline{\text{---}}$ 3A/ 15V $\overline{\text{---}}$ 3A/20V $\overline{\text{---}}$ 3A (60W Max)
USB-C 1 Output	5V $\overline{\text{---}}$ 3A/ 9V $\overline{\text{---}}$ 3A/ 15V $\overline{\text{---}}$ 3A/20V $\overline{\text{---}}$ 3A (60W Max)
USB-C 2 Output	5V $\overline{\text{---}}$ 3A/ 9V $\overline{\text{---}}$ 2.25A (20W Max)
Discharging Temperature	-4°F-104°F / -20°C-40°C
Charging Temperature	32°F-104°F / 0°C-40°C
Size	21.6*21.14*14.4cm/ 8.5*8.32*5.67inches
Net Weight	3.9kg/8.6lbs

Attention



Not permitted on aircraft.

IMPORTANT SAFETY INSTRUCTIONS

WARNING - When using this product, basic precautions should always be followed, including the following: Read all the instructions before using the product.

- To reduce the risk of injury, close supervision is necessary when the product is used near children.
- Do not put fingers or hands into the product.
- Do not expose the product to rain or snow.
- Use of a power supply or charger not recommended or sold by the product manufacturer may result in a risk of fire or injury to persons.

To reduce risk of damage to the electric plug and cord, pull the plug rather than the cord when disconnecting the product.

- Do not use the product in excess of its output rating. Overload outputs above rating may result in a risk of fire or injury to persons.
- Do not use the product that is damaged or modified. Damaged or modified batteries may exhibit unpredictable behavior resulting in fire, explosion or risk of injury.

Do not operate the product with a damaged cord or plug, or a damaged output cable.

- Do not disassemble the product. Take it to a qualified service person when service or repair is required. Incorrect reassembly may result in a risk of fire or electric shock.
- Do not expose to fire or high temperatures. Exposure to fire or temperatures above 130°C may cause explosion. To reduce the risk of electric shock, unplug the power pack from the outlet before attempting any instructed servicing.
- Have servicing performed by a qualified repair person using only identical replacement parts. This will ensure that the safety of the product is maintained.
- When charging a device, the product may feel warm, this is a normal operating condition and should not be cause for concern.

When charging the internal battery, work in a well ventilated area and do not restrict ventilation in any way.

- Do not clean the product with harmful chemicals or detergents.
- Misuse, dropping or excessive force may cause product damage.
- When disposing of secondary cells or batteries, keep cells or batteries of different electrochemical systems separate from each other.
- Do not use or store the power station in direct sunlight for an extended period, such as in a car, cargo bed, or any other place where it will be exposed to high temperatures. Doing so may cause the product to malfunction, deteriorate, or generate heat.

Storage and Maintenance instructions

1. Store the product between 32°F-104°F (0°C-40°C). Avoid exposing the product to rain or using the product in a humid environment.
2. To preserve the battery lifespan, charge to 100% after using. If you plan to store your power station, recharge to 100% every 3 months.
3. Keep the product on a flat surface when using, charging, and storing.

FCC Statement

This device complies with Part 15 of the FCC Rules. Operation is subject to the following two conditions: (1) This device may not cause harmful interference, and (2) this device must accept any interference received, including interference that may cause undesired operation.

Warning: Changes or modifications not expressly approved by the party responsible for compliance could void the user's authority to operate the equipment.

Note: This equipment has been tested and found to comply with the limits for a Class B digital device, pursuant to Part 15 of the FCC Rules. These limits are designed to provide reasonable protection against harmful interference in a residential installation.

This equipment generates, uses, and can radiate radio frequency energy and, if not installed and used in accordance with the instructions, may cause harmful interference to radio communications. However, there is no guarantee that interference will not occur in a particular installation. If this equipment does cause harmful interference to radio or television reception, which can be determined by turning the equipment off and on, the

user is encouraged to try to correct the interference by one or more of the following measures:

- (1) Reorient or relocate the receiving antenna.
- (2) Increase the separation between the equipment and receiver.
- (3) Connect the equipment into an outlet on a circuit different from that to which the receiver is connected.
- (4) Consult the dealer or an experienced radio / TV technician for help.

The following importer is the responsible party.

Company Name: Fantasia Trading LLC

Address: 5350 Ontario Mills Pkwy, Suite 100, Ontario, CA 91764

Telephone: +1-800-988-7973

IC Statement

This device complies with Industry Canada license-ICES-003. Operation is subject to the following two conditions: (1) This device may not cause interference, and (2) This device must accept any interference, including interference that may cause undesired operation of the device.

Le présent appareil est conforme aux CNR d'Industrie Canada applicables aux appareils radio exempts de licence. L'exploitation est autorisée aux deux conditions suivantes : (1) l'appareil ne doit pas produire de brouillage, et (2) l'utilisateur de l'appareil doit accepter tout brouillage radioélectrique subi, même si le brouillage est susceptible d'en compromettre le fonctionnement.

This digital apparatus complies with CAN ICES-003(B)/NMB-003(B).

Declaration of Conformity

Hereby, Anker Innovations Limited declares that the product type A1721 is in compliance with Directives 2014/35/EU & 2014/30/EU & 2011/65/EU. The full text of the EU declaration of conformity is available at the following internet address:

<https://www.anker.com>

GB Declaration of Conformity

Hereby, Anker Innovations Limited declares that the product type A1721 is in compliance with Electrical Equipment (Safety) Regulations 2016 & Electromagnetic Compatibility Regulations 2016 & The Restriction of the Use of Certain Hazardous Substances in Electrical and Electronic Equipment Regulations 2012. The full text of the GB declaration of conformity is available at the following internet address:

<https://www.anker.com>.

Anker Innovations Limited | Room 1318-19, Hollywood Plaza, 610 Nathan Road, Mongkok, Kowloon, HongKong
The following importer is the responsible party (contract for EU and UK matters)
Anker Innovations Deutschland GmbH | Georg-Muche-Strasse 3, 80807 Munich, Germany
Anker Technology (UK) Limited, GNR8, 49 Clarendon Road, Watford, Hertfordshire, WD17 1HP, United Kingdom



This symbol indicates that this product shall not be treated as household waste. Instead it shall be handed over to the applicable collection point for the recycling of electrical and electronic equipment.

Overview

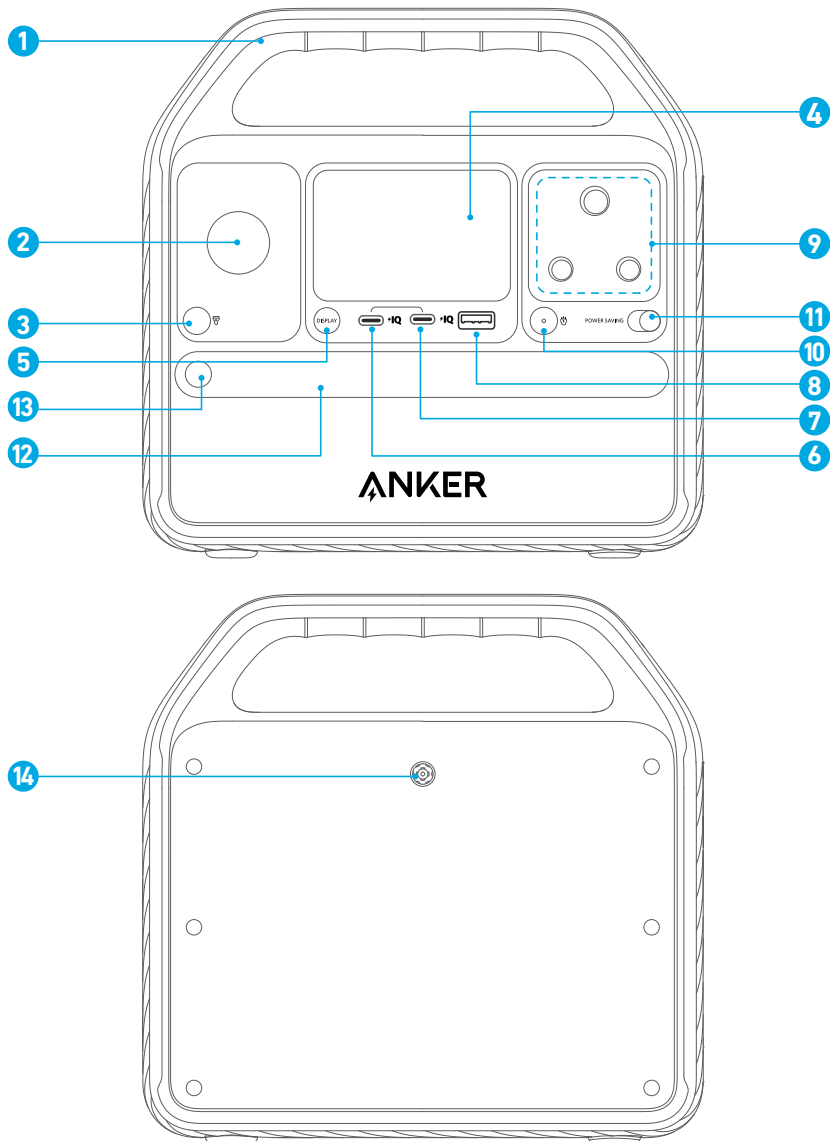

- | | |
|------------------------------------|---------------------------------|
| 1 Handle | 2 Car Socket |
| 3 Car Socket On/Off Button | 4 LCD Screen |
| 5 LCD Screen On/Off Button | 6 USB-C Input/Output Port |
| 7 USB-C Output Port | 8 USB-A Output Port |
| 9 AC Output Port | 10 AC Output Port On/Off Button |
| 11 Power Saving Mode On/Off Switch | 12 Ambient Light |
| 13 Ambient Light On/Off Button | 14 DC Input Port |

Recharging Your Power Station

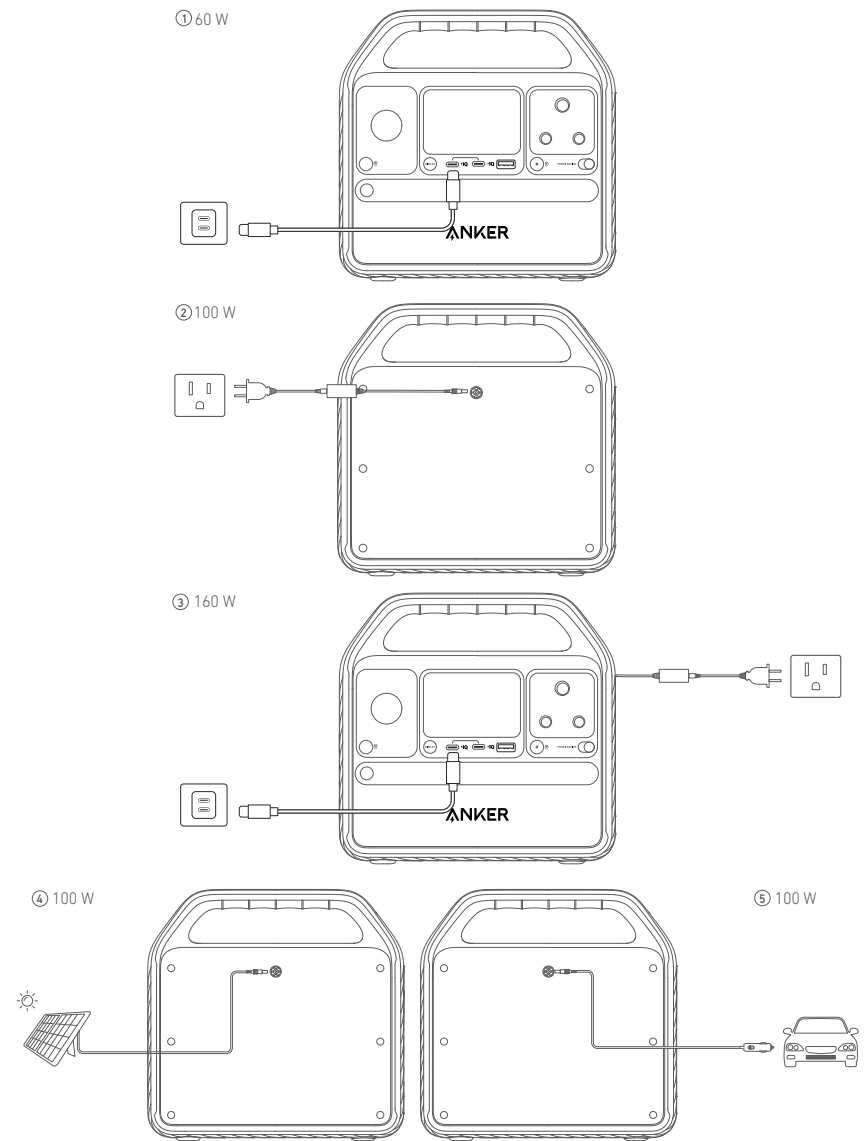

- Please fully charge the product before using it for the first time.
- When your portable power station only has 1% battery remaining, the indicators will flicker to remind you to recharge the device.

Powering Your Devices

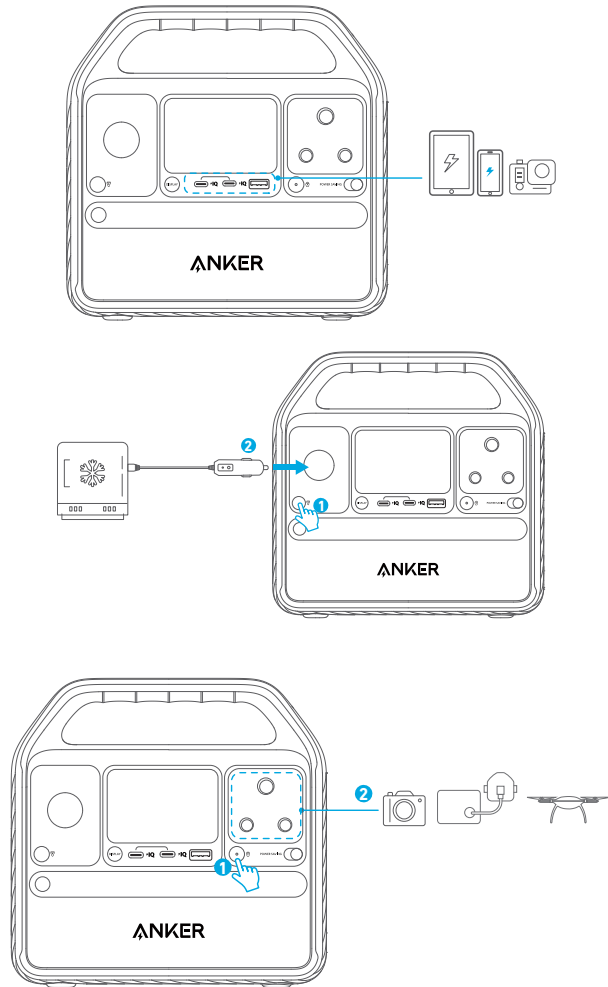

1. The USB-A and USB-C ports support plug and charge. When devices are plugged in, they will start charging automatically; when devices are unplugged, they will turn off automatically.
2. The car socket and AC output port do not support plug and charge. Use the corresponding on/off buttons to turn them on before charging.
3. To avoid draining the battery, we recommend keeping Power Saving Mode turned on except when you are charging low-powered devices like CPAP machines and cameras.

Power Saving Mode

Switching on the power saving mode prevents wasting power by automatically turning off the Power Station once all your devices are fully charged. Switching off the power saving mode will enable stable charging over an extended period, such as for time-lapse photography or for sleeping with a CPAP machine.

LCD Screen Guide

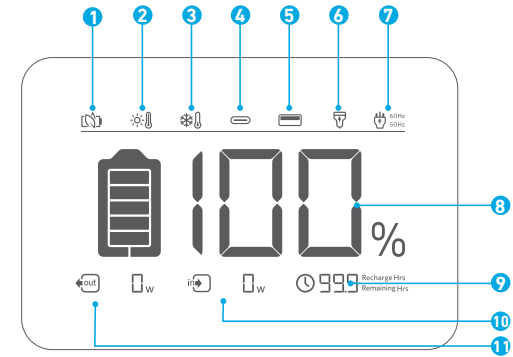

- 1 Power Saving Mode
- 2 High-Temperature Alert
 - When this icon shows, stop using the product and leave it to cool down until the icon disappears.
- 3 Low-Temperature Alert
 - When this icon shows, stop using the product until the icon disappears.
- 4 USB-C Input/Output Port
- 5 USB-A Output
- 6 Car Charging
- 7 60Hz
50Hz
AC Charging and Voltage Frequency
- 8 100%
Remaining Battery
- 9 999 Recharge Hrs
Remaining Hrs
Remaining Battery in Hours
- 10 in W
Current Input Power
- 11 out W
Current Output Power

Flashlight Mode

Press the button once to turn on the ambient light.

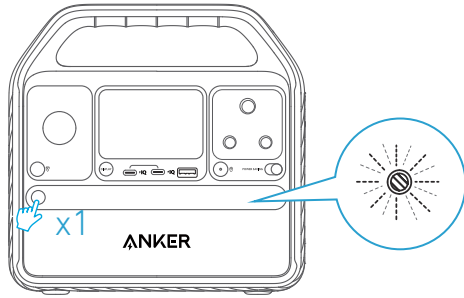

Hold the button for 2 seconds to turn on SOS mode.

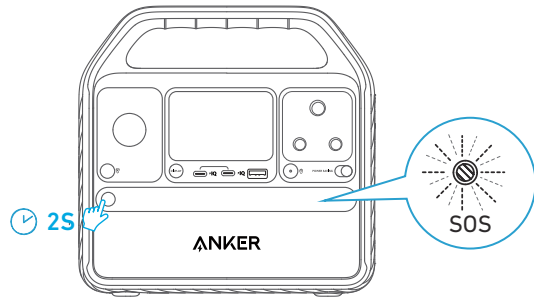

Trouble Shooting

Resetting Your Power Station

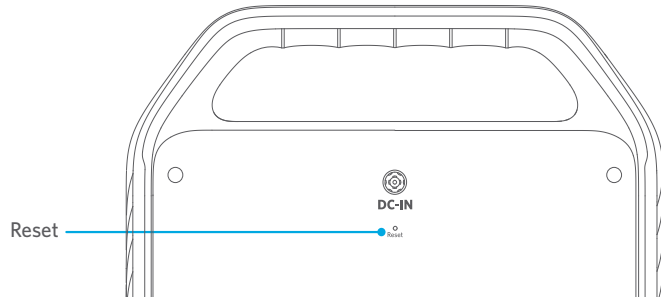

If your Power Station isn't working correctly, insert a paper clip or pin into the reset hole for 1 second for a factory reset. If the Power Station still doesn't work, please contact support@anker.com.

FAQ

Q1: What's the max power output of the AC port?

300W, and if you use the AC port for devices greater than 300W, the product will automatically turn off.

Q2: Can I recharge the product while charging connected devices?

Yes.

Q3: Can this product power a CPAP?

Yes, but do not forget to turn off the Power Saving Mode first.

Q4: Will this product lose power automatically if not powered off?

Yes, when the car socket or AC control button is turned on, even if no devices are being charged, there will still be a certain amount of no-load power consumption. To avoid draining the battery, we recommend keeping Power Saving Mode turned on except when you are charging low-powered devices like CPAP machines and cameras.

Q5: What kind of solar charger can charge this product?

Any 11V-28V solar charger with a DC 8mm (DC 7909) male connector.

Specifications

Cell Capacity	320 Wh
DC Input	11-28V $\overline{\text{---}}$ 9A (100W Max)
Car Charger Output	12V $\overline{\text{---}}$ 10A
AC Output	230V-,1.3A Max, 50Hz, 300W Max
USB-A Output	5V $\overline{\text{---}}$ 2.4A (12W Max)
USB-C 1 Input	5V $\overline{\text{---}}$ 3A/ 9V $\overline{\text{---}}$ 3A/ 15V $\overline{\text{---}}$ 3A/20V $\overline{\text{---}}$ 3A (60W Max)
USB-C 1 Output	5V $\overline{\text{---}}$ 3A/ 9V $\overline{\text{---}}$ 3A/ 15V $\overline{\text{---}}$ 3A/20V $\overline{\text{---}}$ 3A (60W Max)
USB-C 2 Output	5V $\overline{\text{---}}$ 3A/ 9V $\overline{\text{---}}$ 2.25A (20W Max)
Discharging Temperature	-4°F-104°F / -20°C-40°C
Charging Temperature	32°F-104°F / 0°C-40°C
Size	21.6*21.14*14.4cm/ 8.5*8.32*5.67inches
Net Weight	3.9kg/8.6lbs

Attention



Not permitted on aircraft.

IMPORTANT SAFETY INSTRUCTIONS

WARNING - When using this product, basic precautions should always be followed, including the following: Read all the instructions before using the product.

- To reduce the risk of injury, close supervision is necessary when the product is used near children.
- Do not put fingers or hands into the product.
- Do not expose the product to rain or snow.
- Use of a power supply or charger not recommended or sold by the product manufacturer may result in a risk of fire or injury to persons.
- To reduce risk of damage to the electric plug and cord, pull the plug rather than the cord when disconnecting the product.
- Do not use the product in excess of its output rating. Overload outputs above rating may result in a risk of fire or injury to persons.
- Do not use the product that is damaged or modified. Damaged or modified batteries may exhibit unpredictable behavior resulting in fire, explosion or risk of injury.
- Do not operate the product with a damaged cord or plug, or a damaged output cable.
- Do not disassemble the product. Take it to a qualified service person when service or repair is required. Incorrect reassembly may result in a risk of fire or electric shock.
- Do not expose to fire or high temperatures. Exposure to fire or temperatures above 265 °F may cause explosion.
- To reduce the risk of electric shock, unplug the power pack from the outlet before attempting any instructed servicing.
- Have servicing performed by a qualified repair person using only identical replacement parts. This will ensure that the safety of the product is maintained.
- When charging a device, the product may feel warm, this is a normal operating condition and should not be cause for concern.
- When charging the internal battery, work in a well ventilated area and do not restrict ventilation in any way.
- Do not clean the product with harmful chemicals or detergents.
- Misuse, dropping or excessive force may cause product damage.
- When disposing of secondary cells or batteries, keep cells or batteries of different electrochemical systems separate from each other.

CAUTION: Risk of explosion if the battery is replaced by an incorrect type.

- Disposal of a battery into fire or a hot oven, or mechanically crushing or cutting of a battery, can result in an explosion;
- Leaving a battery in an extremely high temperature environment can result in an explosion or leakage of flammable liquid or gas;
- A battery subjected to extremely low air pressure may cause an explosion or leakage of flammable liquid or gas;
- Unplug the AC power cable to disconnect from line voltage.

Storage and Maintenance instructions

1. Store the product between 32°F-104°F (0°C-40°C). Avoid exposing the product to rain or using the product in a humid environment.
2. To preserve the battery lifespan, charge to 100% after using. If you plan to store your power station, recharge to 100% every 3 months.
3. Keep the product on a flat surface when using, charging, and storing.

FCC Statement

This device complies with Part 15 of the FCC Rules. Operation is subject to the following two conditions: (1) This device may not cause harmful interference, and (2) this device must accept any interference received, including interference that may cause undesired operation.

Warning: Changes or modifications not expressly approved by the party responsible for compliance could void the user's authority to operate the equipment.

Note: This equipment has been tested and found to comply with the limits for a Class B digital device, pursuant to Part 15 of the FCC Rules. These limits are designed to provide reasonable protection against harmful interference in a residential installation.

This equipment generates, uses, and can radiate radio frequency energy and, if not installed and used in

accordance with the instructions, may cause harmful interference to radio communications. However, there is no guarantee that interference will not occur in a particular installation. If this equipment does cause harmful interference to radio or television reception, which can be determined by turning the equipment off and on, the user is encouraged to try to correct the interference by one or more of the following measures:

- (1) Reorient or relocate the receiving antenna.
- (2) Increase the separation between the equipment and receiver.
- (3) Connect the equipment into an outlet on a circuit different from that to which the receiver is connected.
- (4) Consult the dealer or an experienced radio / TV technician for help.

The following importer is the responsible party.

Company Name: Fantasia Trading LLC

Address: 5350 Ontario Mills Pkwy, Suite 100, Ontario, CA 91764

Telephone: +1-800-988-7973

IC Statement

This device complies with Industry Canada license-ICES-003. Operation is subject to the following two conditions: (1) This device may not cause interference, and (2) This device must accept any interference, including interference that may cause undesired operation of the device.

Le présent appareil est conforme aux CNR d'Industrie Canada applicables aux appareils radio exempts de licence. L'exploitation est autorisée aux deux conditions suivantes : (1) l'appareil ne doit pas produire de brouillage, et (2) l'utilisateur de l'appareil doit accepter tout brouillage radioélectrique subi, même si le brouillage est susceptible d'en compromettre le fonctionnement.

This digital apparatus complies with CAN ICES-003(B)/NMB-003(B).

Declaration of Conformity

Hereby, Anker Innovations Limited declares that the product type A1721 is in compliance with Directives 2014/35/EU & 2014/30/EU & 2011/65/EU. The full text of the EU declaration of conformity is available at the following internet address:

<https://www.anker.com>

GB Declaration of Conformity

Hereby, Anker Innovations Limited declares that the product type A1721 is in compliance with Electrical Equipment (Safety) Regulations 2016 & Electromagnetic Compatibility Regulations 2016 & The Restriction of the Use of Certain Hazardous Substances in Electrical and Electronic Equipment Regulations 2012. The full text of the GB declaration of conformity is available at the following internet address:

<https://www.anker.com>

Anker Innovations Limited | Room 1318-19, Hollywood Plaza, 610 Nathan Road, Mongkok, Kowloon, HongKong

The following importer is the responsible party (contract for EU and UK matters)

Anker Innovations Deutschland GmbH | Georg-Muche-Strasse 3, 80807 Munich, Germany

Anker Technology (UK) Limited | GNR8, 49 Clarendon Road, Watford, Hertfordshire, WD17 1HP, United Kingdom



This symbol indicates that this product shall not be treated as household waste. Instead it shall be handed over to the applicable collection point for the recycling of electrical and electronic equipment.

Übersicht

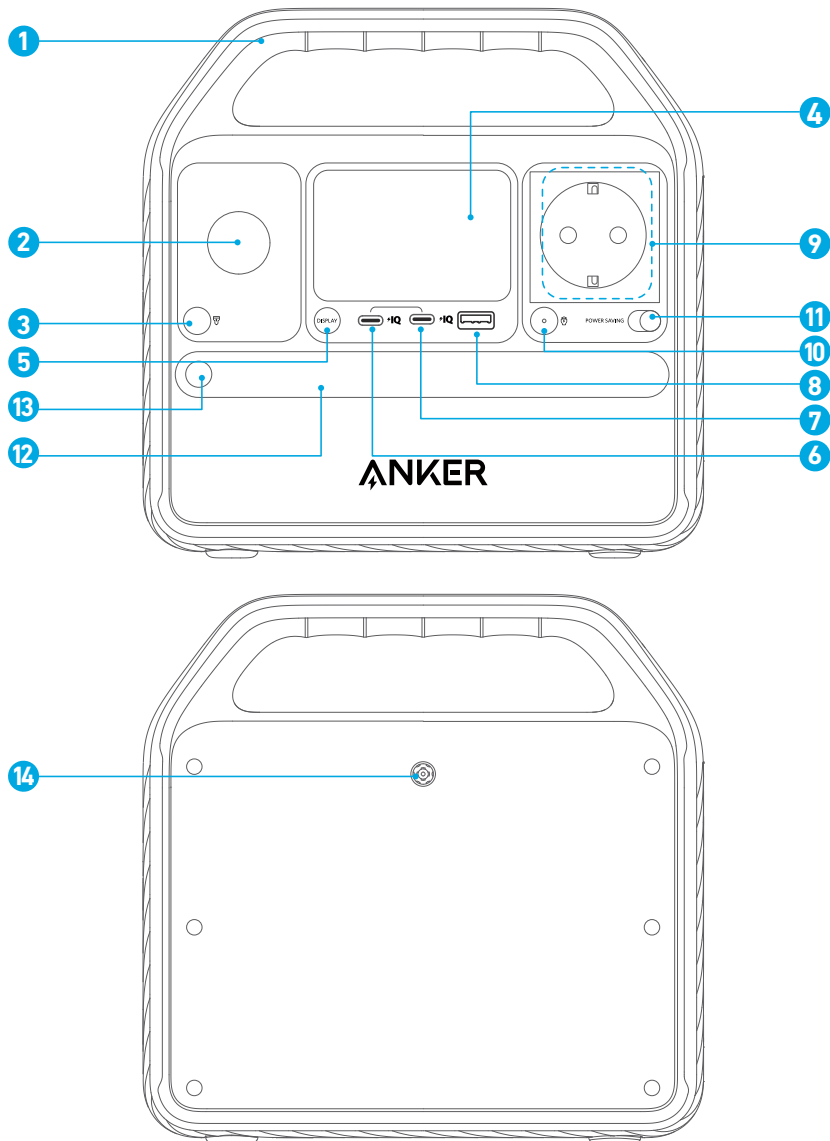

- | | |
|--------------------------------------|---|
| 1 Handgriff | 2 Auto-Steckdose |
| 3 Auto-Steckdose - Ein/Aus-Taste | 4 LCD-Bildschirm |
| 5 LCD-Bildschirm - Ein/Aus-Taste | 6 USB-C Eingangs-/Ausgangsanschluss |
| 7 USB-C Ausgangsanschluss | 8 USB-A Ausgangsanschluss |
| 9 AC-Ausgangsanschluss | 10 AC-Ausgangsanschluss - Ein/Aus-Taste |
| 11 Energiesparmodus Ein/Aus-Schalter | 12 Umgebungslicht |
| 13 Taste für Umgebungslicht ein/aus | 14 DC-Eingangsanschluss |

Aufladen der Stromversorgungseinheit

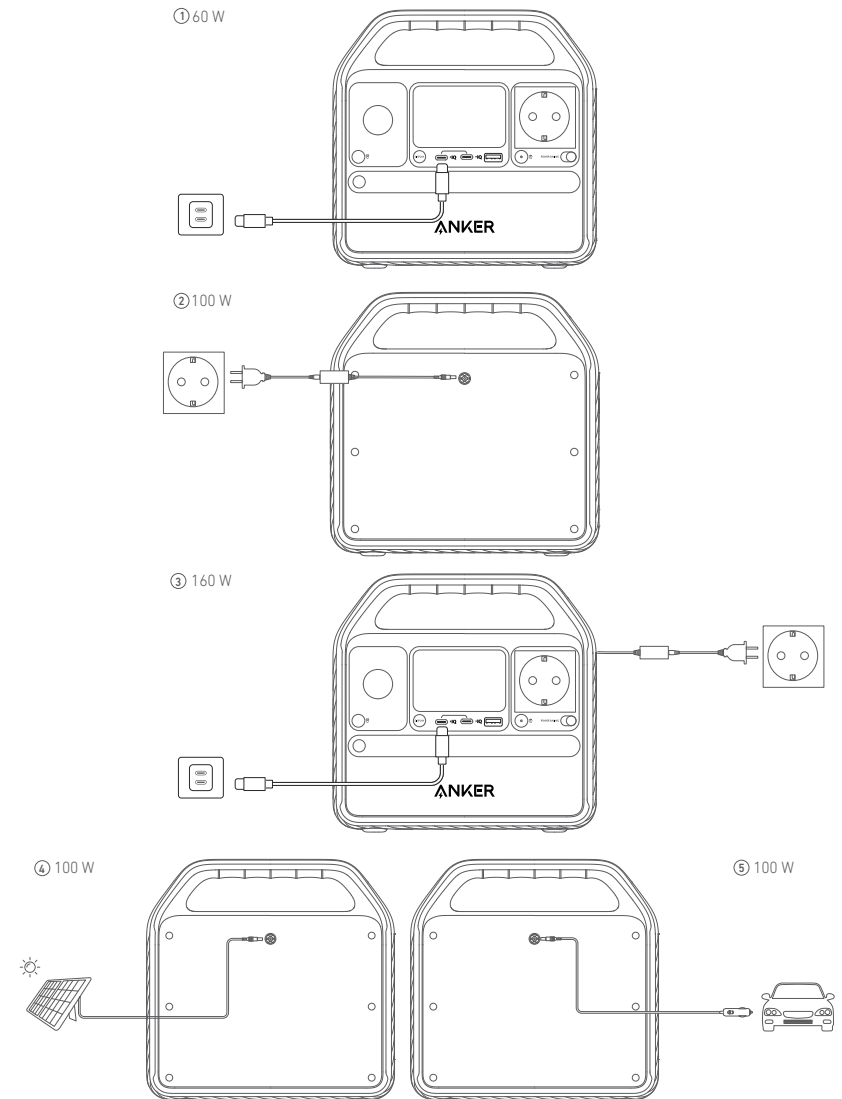

- Bitte das Produkt vor der ersten Verwendung vollständig aufladen.
- Wenn Ihre tragbare Stromversorgungseinheit nur noch über eine Restbatterie von 1 % verfügt, flackert die Restbatterieanzeige, um Sie daran zu erinnern, das Gerät aufzuladen.

Stromversorgung der Geräte

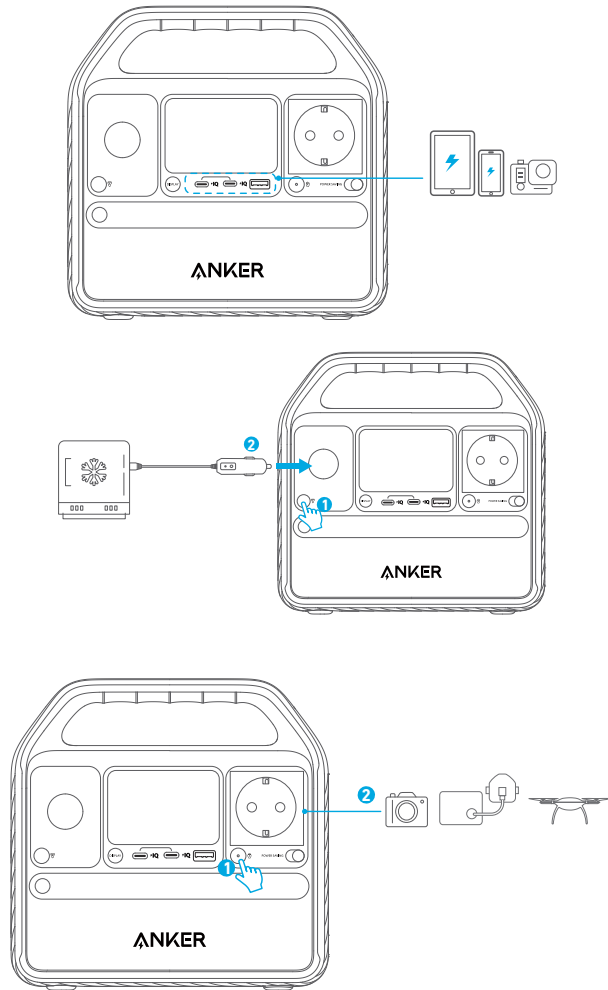

1. Die USB-A- und USB-C-Anschlüsse unterstützen Plug & Charge. Wenn die Geräte eingesteckt werden, beginnen sie automatisch mit dem Aufladen; wenn sie ausgesteckt werden, schalten sie sich automatisch aus.
2. Die Kfz-Steckdose und der AC-Ausgang unterstützen kein Plug & Charge. Schalten Sie die Geräte vor dem Aufladen mit den entsprechenden Ein/Aus-Tasten ein.
3. Um eine Entladung des Akkus zu vermeiden, empfehlen wir, den Energiesparmodus eingeschaltet zu lassen, es sei denn, Sie laden Geräte mit geringem Stromverbrauch wie CPAP-Geräte und Kameras.

Energiesparmodus

Durch Aktivieren des Energiesparmodus verhindern Sie einen unnötigen Stromverbrauch, indem die Stromversorgungseinheit automatisch abgeschaltet wird, sobald alle angeschlossenen Geräte vollständig aufgeladen sind. Deaktivieren Sie den Energiesparmodus in Fällen, in denen eine stabile Stromversorgung über einen längeren Zeitraum wichtig ist, beispielsweise bei Zeitraffer-Fotografie oder wenn Sie zum Schlafen ein CPAP-Gerät verwenden.

LCD-Bildschirm-Anleitung

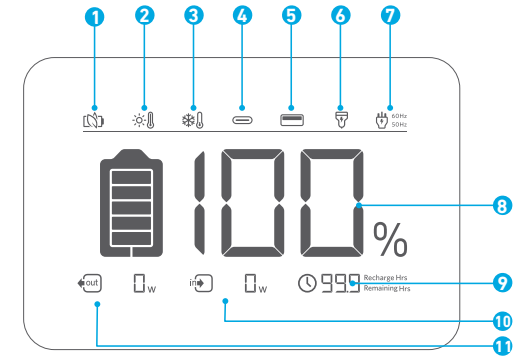

- 1 Energiesparmodus
- 2 Hochtemperatur-Alarm
 - Wenn dieses Symbol erscheint, verwenden Sie das Produkt nicht mehr und lassen Sie es abkühlen, bis das Symbol verschwindet.
- 3 Niedrigtemperatur-Alarm
 - Wenn dieses Symbol angezeigt wird, verwenden Sie das Produkt nicht mehr, bis das Symbol verschwindet.
- 4 USB-C Eingangs-/Ausgangsanschluss
- 5 USB-A-Ausgang
- 6 Auto-Laden
- 7 60Hz
50Hz
AC-Laden und Stromspannung Frequenz
- 8 Verbleibende Batterie
- 9 Recharge Hrs
Remaining Hrs
Verbleibende Batterieleistung in Stunden
- 10 Strom Eingangsleistung
- 11 Strom Ausgangsleistung

Taschenlampenmodus

Drücken Sie die Taste einmal, um das Umgebungslicht einzuschalten.

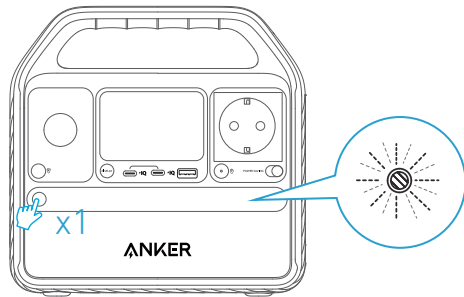

Halten Sie die Taste 2 Sekunden lang gedrückt, um den SOS-Modus einzuschalten.

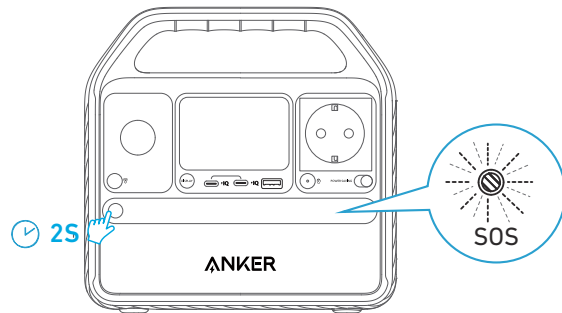

Fehlerbehebung

Zurücksetzen der Stromversorgungseinheit

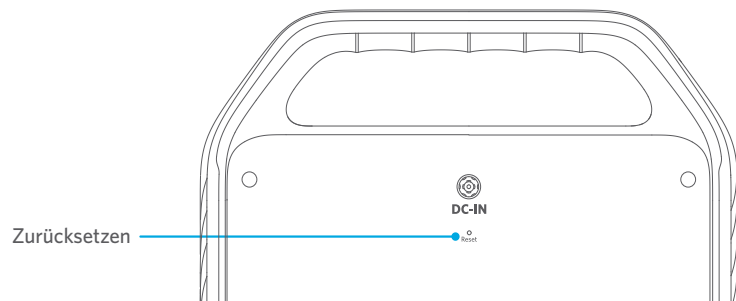

Wenn die Stromversorgungseinheit nicht richtig funktioniert, stecken Sie eine Büroklammer oder eine Nadel für 1 Sekunde in die Zurücksetz-Öffnung, um sie auf die Werkseinstellungen zurückzusetzen. Wenn die Stromversorgungseinheit weiterhin nicht funktioniert, schreiben Sie bitte eine E-Mail an support@anker.com.

FAQ

F1: Wie hoch ist die maximale Ausgangsleistung des AC-Anschlusses?

Wenn Sie den Netzanschluss für Geräte mit einer Leistung von mehr als 300 W verwenden, schaltet sich das Gerät automatisch aus.

F2: Kann ich das Produkt aufladen, während ich angeschlossene Geräte auflade?

Ja.

F3: Kann dieses Produkt ein CPAP mit Strom versorgen?

Ja, aber vergessen Sie nicht, zuerst den Energiesparmodus auszuschalten.

F4: Verliert dieses Produkt automatisch an Leistung, wenn es nicht ausgeschaltet wird?

Ja, wenn die Steckdose oder die Bedientaste für den Wechselstrom eingeschaltet ist, wird immer noch eine gewisse Menge an Leerlaufstrom verbraucht, auch wenn keine Geräte geladen werden. Um eine Entladung des Akkus zu vermeiden, empfehlen wir, den Energiesparmodus eingeschaltet zu lassen, es sei denn, Sie laden Geräte mit geringem Stromverbrauch wie CPAP-Geräte und Kameras.

F5: Welche Art von Solarladegerät kann dieses Produkt aufladen?

Jedes 11 - 28 V Solarladegerät mit einem DC 7909 Stecker (8 mm).

Technische Daten

Batteriezellenkapazität	320 Wh
DC-Eingang	11-28 V $\overline{\text{---}}$ 9 A (100 W max.)
Autoladegerät-Ausgang	12 V $\overline{\text{---}}$ 10 A
AC-Ausgang	230V-,1,3A Max, 50Hz, 300W max
USB-A Ausgang	5 V $\overline{\text{---}}$ 2,4 A (12W max)
USB-C 1-Eingang	5 V $\overline{\text{---}}$ 3 A/ 9 V $\overline{\text{---}}$ 3 A/ 15 V $\overline{\text{---}}$ 3 A/20 V $\overline{\text{---}}$ 3 A (60 W max)
USB-C 1-Ausgang	5V $\overline{\text{---}}$ 3 A/9 V $\overline{\text{---}}$ 3 A/15 V $\overline{\text{---}}$ 3 A/20 V $\overline{\text{---}}$ 3 A (60 W max)
USB-C 2-Ausgang	5V $\overline{\text{---}}$ 3A/ 9V $\overline{\text{---}}$ 2,25A (20W max)
Entladetemperatur	-4 °F-104 °F/-20 °C-40 °C
Ladetemperatur	32 °F-104 °F/0 °C-40 °C
Größe	21,6*21,14*14,4 cm/ 8,5*8,32*5,67 "
Nettogewicht	3,9 kg

Achtung



In Flugzeugen nicht erlaubt.

WICHTIGE SICHERHEITSANWEISUNGEN

WARNUNG - Bei der Verwendung dieses Produkts sollten immer grundlegende Vorsichtsmaßnahmen beachtet werden, einschließlich der folgenden:

Lesen Sie die gesamte Gebrauchsanweisung, bevor Sie das Produkt verwenden.

- Um die Verletzungsgefahr zu verringern, muss das Produkt bei der Verwendung in der Nähe von Kindern genau überwacht werden.
- Stecken Sie weder Finger noch Hände in das Produkt.
- Setzen Sie das Produkt nicht Regen oder Schnee aus.
- Die Verwendung eines Netz- oder Ladegeräts, das nicht vom Hersteller des Produkts empfohlen oder verkauft wird, kann zu Brand- oder Verletzungsgefahr führen.
- Um das Risiko einer Beschädigung des Steckers und des Kabels zu verringern, ziehen Sie beim Ausstecken des Geräts am Stecker und nicht am Kabel.
- Verwenden Sie das Produkt nicht über seine Nennleistung hinaus. Überlastungsausgänge über dem Nennwert können zu Brandgefahr oder Verletzungen führen.
- Verwenden Sie das Produkt nicht, wenn es beschädigt oder verändert ist. Beschädigte oder modifizierte Batterien können ein unvorhersehbares Verhalten zeigen, das zu Feuer, Explosion oder Verletzungsgefahr führen kann.
- Betreiben Sie das Gerät nicht mit einem beschädigten Kabel oder Stecker oder mit einem beschädigten Ausgangskabel.
- Zerlegen Sie das Produkt nicht. Bringen Sie es zu einem qualifizierten Servicetechniker, wenn eine Wartung oder Reparatur erforderlich ist. Bei unsachgemäßem Zusammenbau besteht die Gefahr eines Brandes oder elektrischen Schlages.
- Nicht dem Feuer oder hohen Temperaturen aussetzen. Bei Einwirkung von Feuer oder Temperaturen über 265 °F besteht Explosionsgefahr.
- Um die Gefahr eines Stromschlags zu verringern, ziehen Sie den Netzstecker aus der Steckdose, bevor Sie versuchen, das Gerät zu warten.
- Lassen Sie Wartung und Reparatur von einem qualifizierten Servicetechniker durchführen und verwenden Sie nur identische Ersatzteile. Dadurch wird die Sicherheit des Produkts gewährleistet.
- Beim Laden eines Geräts kann sich das Gerät warm anfühlen. Dies ist ein normaler Betriebszustand und sollte kein Grund zur Sorge sein.
- Arbeiten Sie beim Laden des internen Akkus in einem gut belüfteten Bereich und schränken Sie die Belüftung in keiner Weise ein.
- Reinigen Sie das Produkt nicht mit schädlichen Chemikalien oder Reinigungsmitteln.
- Missbrauch, Herunterfallen oder übermäßige Gewalt können zu Produktschäden führen.
- Trennen Sie bei der Entsorgung von Sekundärzellen oder Akkus Zellen oder Akkus verschiedener elektrochemischer Systeme voneinander.

Hinweise zur Lagerung und Wartung

1. Lagern Sie das Produkt zwischen 0 °C und 40 °C. Vermeiden Sie es, das Produkt Regen auszusetzen oder das Produkt in einer feuchten Umgebung zu verwenden.
2. Um die Lebensdauer des Akkus zu verlängern, laden Sie ihn nach dem Gebrauch auf 100 % auf. Wenn Sie Ihre Stromversorgungseinheit lagern möchten, laden Sie sie alle 3 Monate auf 100 % auf.
3. Legen Sie das Produkt während des Gebrauchs, beim Aufladen und während der Lagerung auf eine ebene Fläche.

Konformitätserklärung

Hiermit erklärt Anker Innovations Limited, dass das Produkt des Typs A1721 mit den Richtlinien 2014/35/EU und 2014/30/EU und 2011/65/EU konform ist. Der vollständige Text der EU-Konformitätserklärung ist unter der folgenden Internetadresse abrufbar:
<https://www.anker.com>

Anker Innovations Limited

Room 1318-19, Hollywood Plaza, 610 Nathan Road, Mongkok, Kowloon, HongKong

Der folgende Importeur ist verantwortlich (für EU- und UK-Belange)

Anker Innovations Deutschland GmbH

Georg-Muche-Strasse 3, 80807 Munich, Germany

Anker Technology (UK) Limited,

GNR8, 49 Clarendon Road, Watford, Hertfordshire, WD17 1HP, United Kingdom



Dieses Symbol bedeutet, dass das Produkt nicht als Hausmüll entsorgt werden darf. Stattdessen ist es an der jeweiligen Sammelstelle für das Recycling von Elektro- und Elektronikgeräten abzugeben.

Descripción general

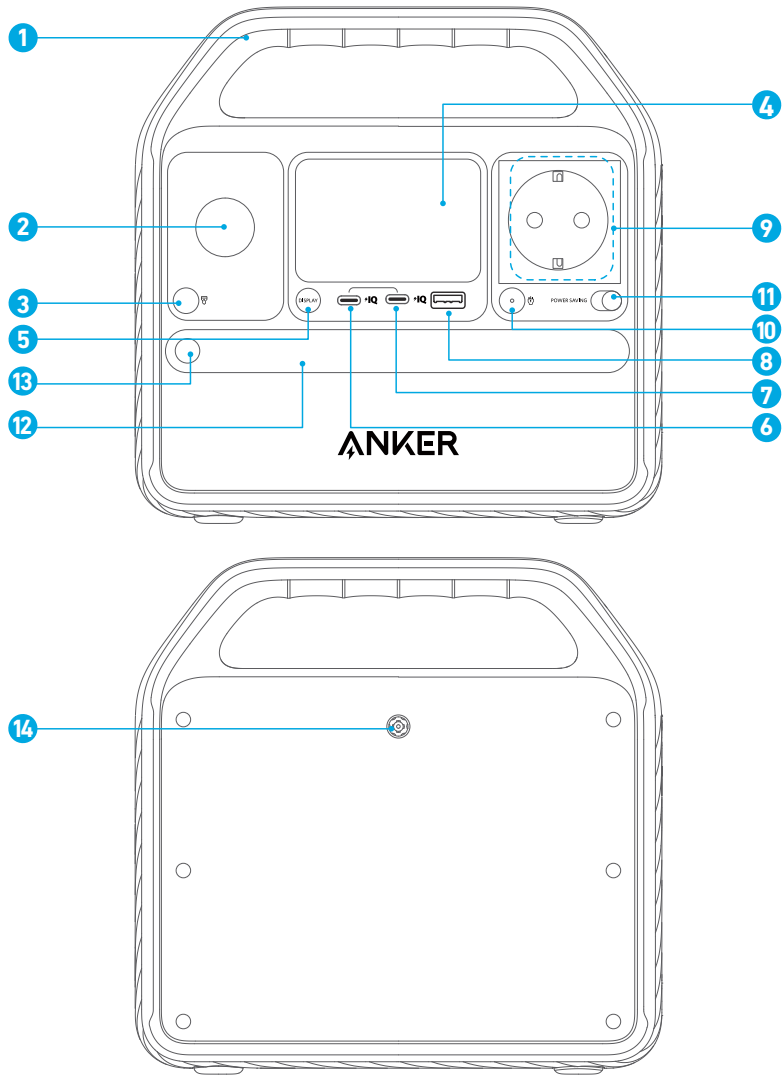

- | | |
|---|----------------------------------|
| 1 Mango | 2 Enchufe del coche |
| 3 Botón de encendido/apagado del enchufe del coche | 4 Pantalla LCD |
| 5 Botón de encendido/apagado de la pantalla LCD | 6 Puerto de entrada/salida USB-C |
| 7 Puerto de salida USB-C | 8 Puerto de salida USB-A |
| 9 Puerto de salida de CA | |
| 10 Botón de encendido/apagado del puerto de salida de CA | |
| 11 Interruptor de encendido/apagado del modo de ahorro de energía | |
| 12 Luz ambiental | |
| 13 Botón de encendido/apagado de luz ambiental | |
| 14 Puerto de entrada de CC | |

Recarga de la estación de energía

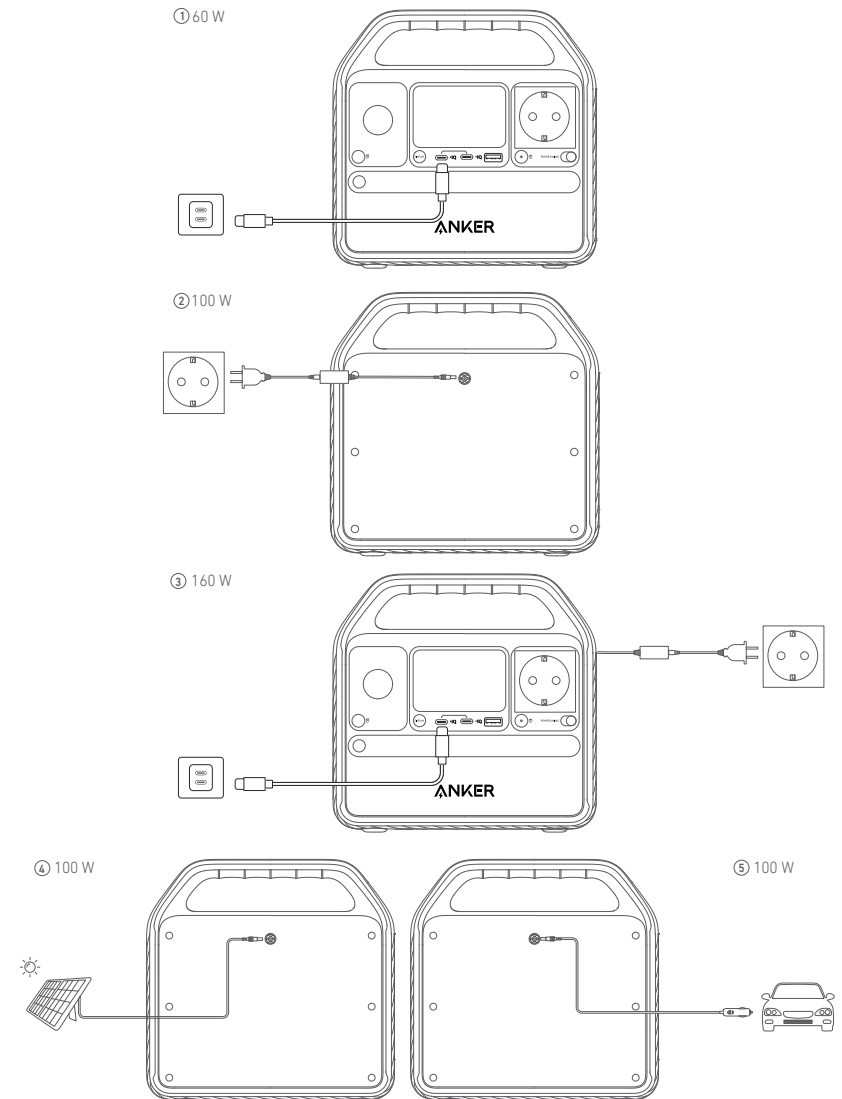

- Cargue el producto del todo antes de usarlo por primera vez.
- Cuando a su estación de energía portátil solo le queda un 1 % de batería, los indicadores de Batería restante parpadearán para recordarle que debe recargar el dispositivo.

Conexión y alimentación de los dispositivos

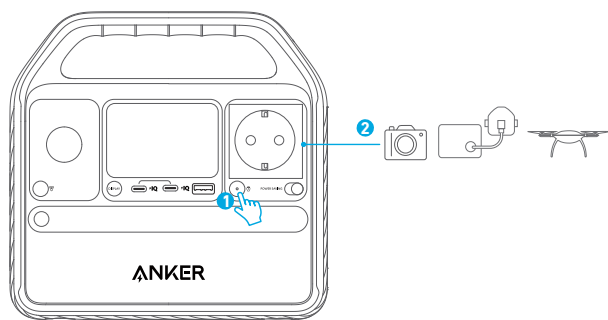
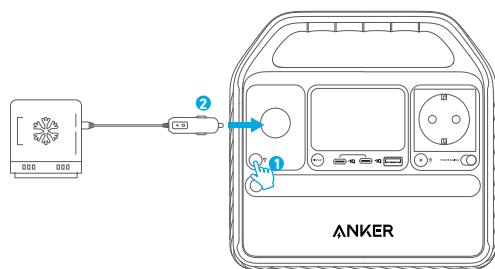
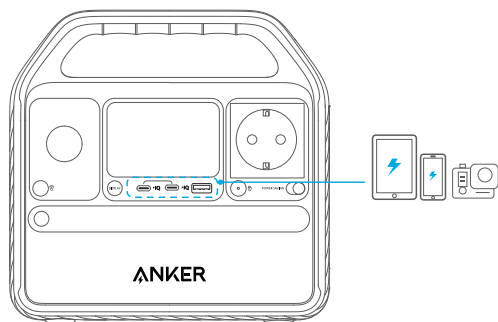

1. Los puertos USB-A y USB-C admiten enchufar y cargar. Cuando los dispositivos estén enchufados, comenzarán a cargarse automáticamente; cuando los dispositivos estén desenchufados, se apagarán automáticamente.
2. El enchufe del coche y el puerto de salida de CA no admiten enchufar y cargar. Utilice los botones de encendido/apagado correspondientes para encenderlos antes de cargar.
3. Para evitar agotar la batería, recomendamos mantener activado el modo de ahorro de energía, excepto cuando esté cargando dispositivos de baja potencia como cámaras y máquinas CPAP.

Modo de ahorro de energía

Si se activa el modo de ahorro de energía, se evita que se derroche energía cuando se apaga la estación de energía automáticamente y una vez que todos los dispositivos están completamente cargados. Al desactivar el modo de ahorro de energía, la carga se mantiene estable durante un período prolongado, por ejemplo, cuando se hacen fotografías a cámara rápida o se duerme con un respirador.

Guía de pantalla LCD

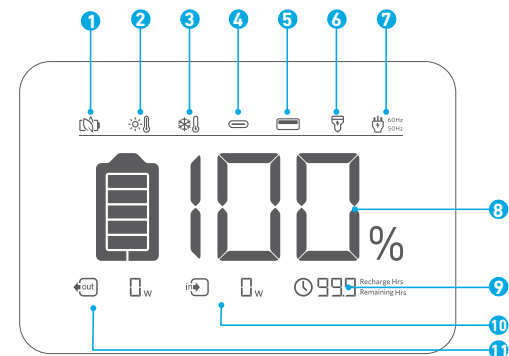

Modo de ahorro de energía



Alerta de alta temperatura

- Cuando aparezca este icono, deje de usar el producto y déjelo enfriar hasta que desaparezca el icono.



Alerta de baja temperatura

- Cuando aparezca este icono, deje de usar el producto hasta que desaparezca.



Puerto de entrada/salida USB-C



Salida USB-A



Carga en el coche



Carga con CA y frecuencia de tensión



Batería restante



Batería restante en horas



Potencia de entrada actual



Potencia de salida actual

Modo linterna

Presione el botón una vez para encender la luz ambiental.

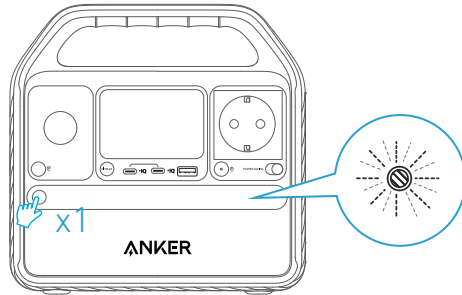

Mantenga presionado el botón durante 2 segundos para activar el modo SOS.

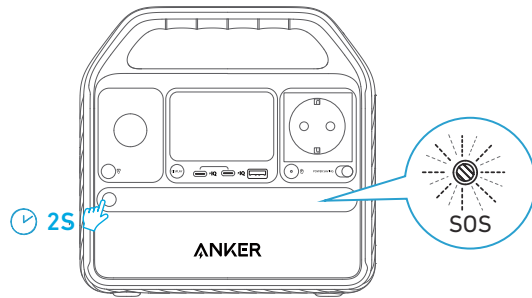

Solución de problemas

Reinicio de la estación de energía

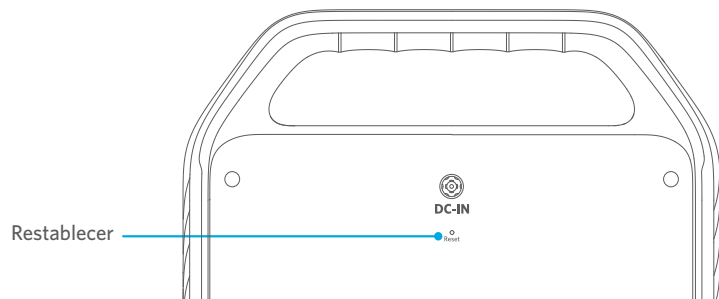

Si la estación de energía no funciona correctamente, introduzca un clip o un alfiler en el orificio de reinicio y déjelo presionado durante 1 segundo para restablecer los valores de fábrica. Si la estación de energía sigue sin funcionar, pida ayuda en support@anker.com.

Preguntas más frecuentes

P1: ¿Cuál es la salida de potencia máxima del puerto de CA?

300 W y, si usa el puerto de CA para dispositivos de más de 300 W, el producto se apagará automáticamente.

P2: ¿Puedo recargar el producto mientras se cargan los dispositivos conectados?

Sí.

P3: ¿Puede este producto proporcionar energía a un CPAP?

Sí, pero no olvide desactivar primero el modo de ahorro de energía.

P4: ¿Este producto perderá energía automáticamente si no se apaga?

Sí, cuando se enciende el enchufe del coche o el botón de control de CA, incluso si no se están cargando dispositivos, seguirá habiendo una cierta cantidad de consumo de energía sin carga. Para evitar agotar la batería, recomendamos mantener activado el modo de ahorro de energía, excepto cuando esté cargando dispositivos de baja potencia como cámaras y máquinas CPAP.

P5: ¿Qué tipo de cargador solar puede cargar este producto?

Cualquier cargador solar de 11-28 V con conector macho de CC de 8 mm (DC 7909).

Especificaciones

Capacidad de celda	320 Wh
Entrada de CC	11-28V $\overline{\text{---}}$ 9A (100W máx)
Salida del cargador del coche	12 V $\overline{\text{---}}$ 10 A
Salida de CA	230V-,1,3A máx, 50Hz, 300W máx
Salida USB-A	5 V $\overline{\text{---}}$ 2,4A (12W máx)
Entrada USB-C 1	5 V $\overline{\text{---}}$ 3 A/ 9 V $\overline{\text{---}}$ 3 A/ 15 V $\overline{\text{---}}$ 3 A/20 V $\overline{\text{---}}$ 3 A (60 W máx)
Potencia de salida de USB-C 1	5 V $\overline{\text{---}}$ 3 A/ 9 V $\overline{\text{---}}$ 3 A/ 15 V $\overline{\text{---}}$ 3 A/20 V $\overline{\text{---}}$ 3 A (60 W máx.)
Potencia de salida de USB-C 2	5V $\overline{\text{---}}$ 3A/ 9V $\overline{\text{---}}$ 2,25A (20W máx)
Temperatura de descarga	-4 °F-104 °F/-20 °C-40 °C
Temperatura de carga	32 °F-104 °F/0 °C-40 °C
Tamaño	21,6*21,14*14,4 cm/ 8,5*8,32*5,67 pulgadas
Peso neto	3,9 kg/8,6 lbs

Atención



No se permite en aviones.

INSTRUCCIONES DE SEGURIDAD IMPORTANTES

ADVERTENCIA: Al usar este producto, se debe tomar en todo momento una serie de precauciones básicas, como las siguientes:

Lea todas las instrucciones antes de usar el producto.

- Para reducir el riesgo de lesiones, es necesario tener a los niños bajo estrecha supervisión cuando se use el producto cerca de ellos.
- No ponga los dedos ni las manos dentro del producto.
- No exponga el producto a la lluvia ni a la nieve.
- Si se usa una fuente de alimentación o un cargador no recomendado ni vendido por el fabricante del producto se puede aumentar el riesgo de incendio o lesiones a las personas.
- Para reducir el riesgo de daño del cable y el enchufe eléctrico, tire del enchufe en lugar del cable cuando desconecte el producto.
- No supere la potencia nominal de salida del producto. Si se sobrecargan las salidas por encima del valor nominal, puede aumentar el riesgo de incendio o lesiones en las personas.
- No utilice un producto que esté dañado o modificado. Las baterías dañadas o modificadas pueden tener un funcionamiento inesperado, lo que podría dar lugar a incendios, explosiones o posibles lesiones.
- No utilice un producto con un cable o enchufe dañados ni con un cable de salida dañado.
- No desmonte el producto. Entrégueselo a un técnico de mantenimiento cualificado cuando sea necesario repararlo o inspeccionarlo. Si se vuelve a montar de forma incorrecta, esto puede provocar riesgo de incendio o descarga eléctrica.
- No lo exponga al fuego ni a altas temperaturas. La exposición al fuego o temperaturas superiores a 265 °F podría hacer que explote.
- Para reducir el riesgo de descarga eléctrica, desenchúfelo antes de intentar cualquier reparación indicada.
- La reparación o mantenimiento lo debe realizar un técnico especializado que trabaje solo con piezas de repuesto idénticas. Esto garantizará que no se menoscabe la seguridad del producto.
- Al cargar un dispositivo, es posible que el producto se caliente; esta es una condición de funcionamiento normal y no debe ser motivo de preocupación.
- Cuando cargue la batería interna, hágalo en un área bien ventilada y no restrinja la ventilación de ninguna manera.
- No limpie el producto con agentes químicos o detergentes nocivos.
- El uso incorrecto, las caídas o el empleo de una fuerza excesiva pueden dañar el producto.
- Al desechar pilas secundarias o baterías que tengan diferentes componentes electroquímicos, procure ponerlas separadas unas de otras.

Instrucciones de almacenamiento y mantenimiento

1. Guarde el producto en lugares con temperaturas de entre 0 °C - 40 °C (32 °F - 104 °F). Evite exponer el producto a la lluvia o utilizar el producto en condiciones de humedad.
2. PİL ömrünü korumak için kullandıktan sonra %100 seviyesine kadar şarj edin. Güç istasyonunuzu saklamayı planlıyorsanız her 3 ayda bir %100 seviyesine kadar şarj edin.
3. Deje el producto sobre una superficie plana cuando lo use, cargue y almacene.

Declaración de conformidad

Por la presente, Anker Innovations Limited declara que este producto tipo A1721 cumple con las Directivas 2014/35/UE, 2014/30/UE y 2011/65/UE. El texto completo de la declaración UE de conformidad está disponible en la siguiente dirección de Internet:

<https://www.anker.com>



Este símbolo indica que el producto no puede desecharse junto con los residuos domésticos. En su lugar, debe llevarse a un punto de recogida adecuado para el reciclaje de aparatos eléctricos y electrónicos.

Aperçu

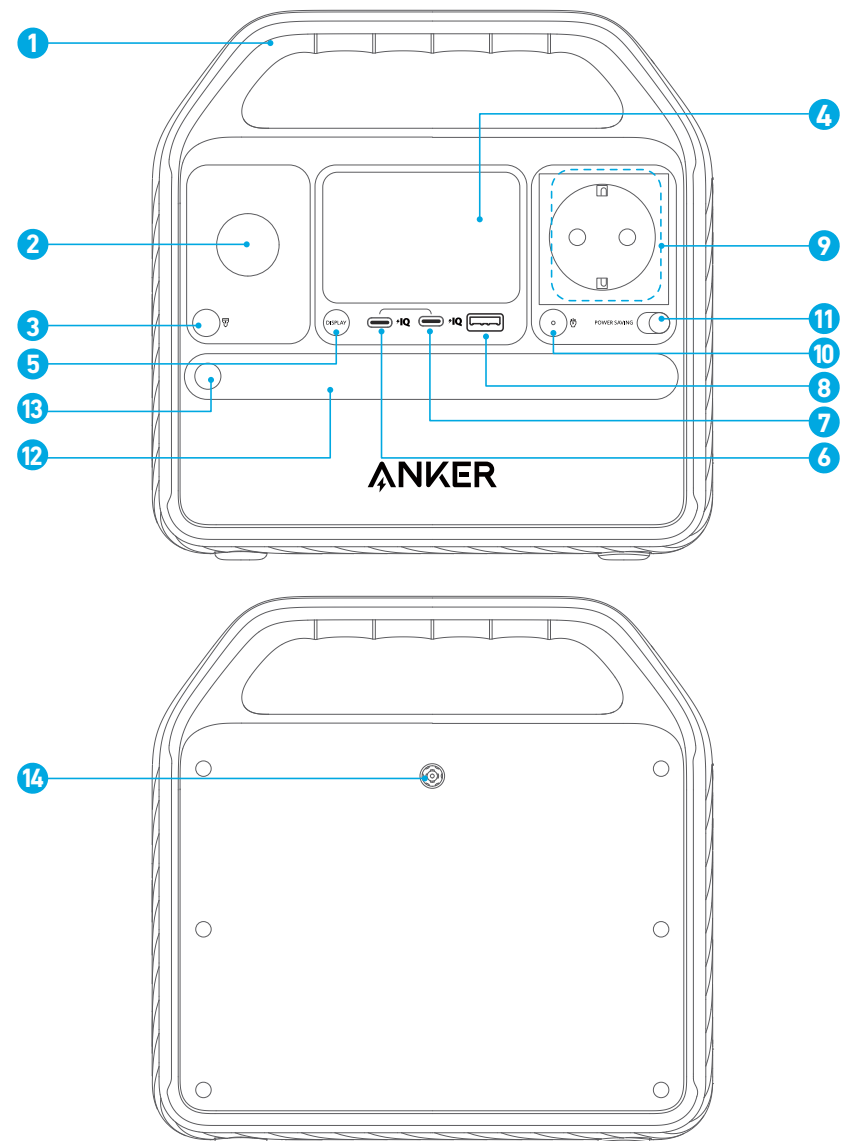

- 1 Poignée
- 2 Prise de voiture
- 3 Bouton marche/arrêt de prise de voiture
- 4 Écran LCD
- 5 Bouton marche/arrêt de l'écran LCD
- 6 Port d'entrée/sortie USB-C
- 7 Port de sortie USB-C
- 8 Port de sortie USB-A
- 9 Port de sortie CA
- 10 Bouton marche/arrêt du port de sortie CA
- 11 Interrupteur marche/arrêt du mode d'économie d'énergie
- 12 Lumière ambiante
- 13 Bouton marche/arrêt de la lumière ambiante
- 14 Port d'entrée CC

Recharge de votre station d'alimentation

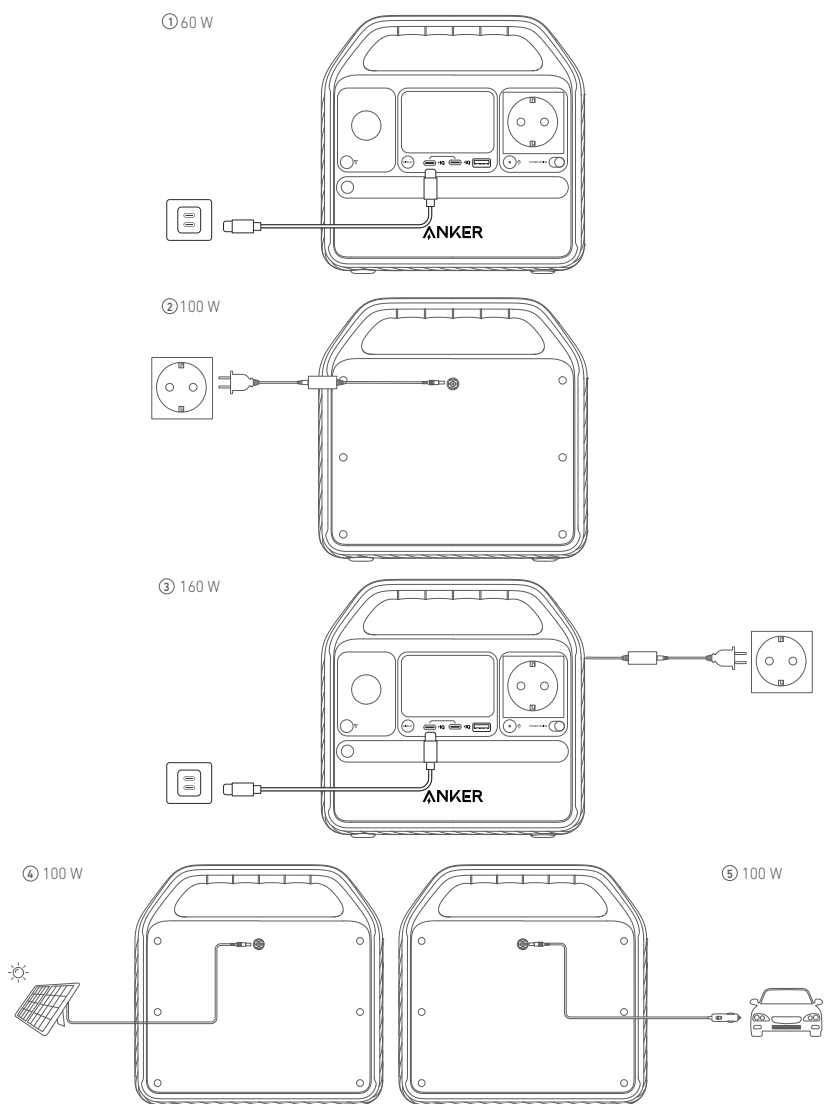

- Veuillez charger complètement le produit avant de l'utiliser pour la première fois.
- Lorsque votre station d'alimentation portable n'a plus que 1 % de batterie, les indicateurs de batterie restante clignotent pour vous rappeler de recharger l'appareil.

Mode d'économie d'énergie

L'activation du mode d'économie d'énergie évite le gaspillage d'énergie en éteignant automatiquement la Power Station une fois que tous vos appareils sont complètement chargés.

La désactivation du mode d'économie d'énergie permettra une charge stable sur une période prolongée, comme pour la photographie par intervalles ou le sommeil avec une machine CPAP.

Alimentation de vos appareils

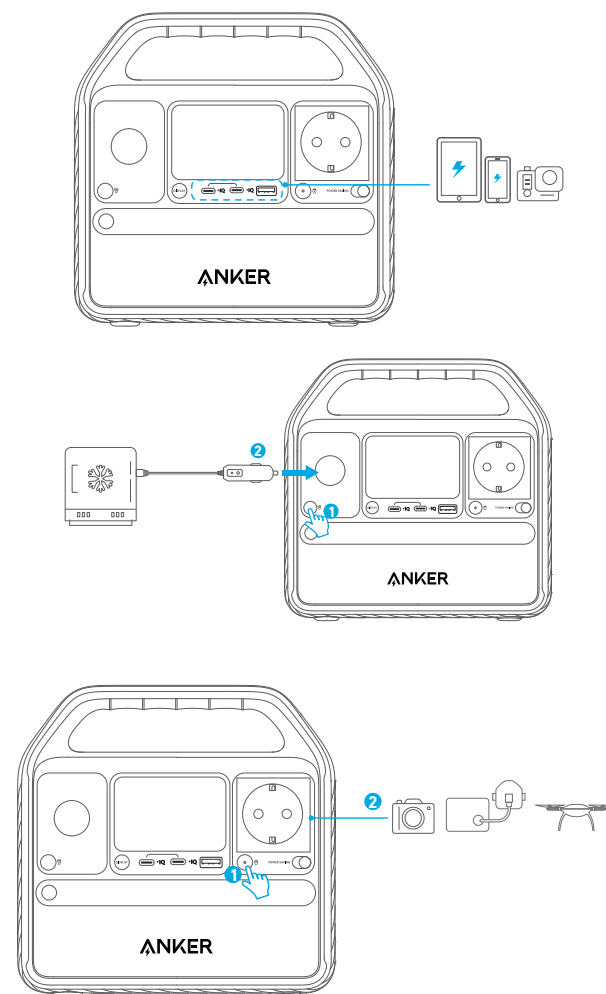

1. Les ports USB-A et USB-C permettent de brancher et de charger. Lorsque les appareils sont branchés, ils commencent à se charger automatiquement ; lorsqu'ils sont débranchés, ils s'éteignent automatiquement.
2. La prise de la voiture et le port de sortie CA ne prennent pas en charge le branchement et la charge. Utilisez les boutons marche/arrêt correspondants pour les allumer avant de les charger.
3. Pour éviter de vider la batterie, nous vous recommandons de laisser le mode économie d'énergie activé, sauf lorsque vous chargez des appareils de faible puissance comme les appareils CPAP et les appareils photo.

Guide de l'écran LCD

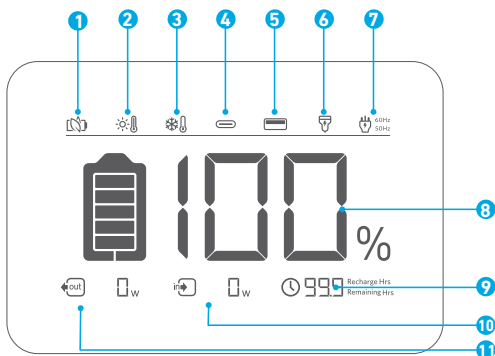

Mode économie d'énergie



Alerte de température élevée

• Lorsque cette icône s'affiche, arrêtez d'utiliser le produit et laissez-le refroidir jusqu'à ce que l'icône disparaisse.



Alerte de basse température

• Lorsque cette icône s'affiche, arrêtez d'utiliser le produit jusqu'à ce que l'icône disparaisse.



Port d'entrée/sortie USB-C



Sortie USB-A



Chargement en voiture



Charge CA et Tension Fréquence



Batterie restante



Batterie restante en heures



Puissance d'entrée actuelle



Puissance de sortie actuelle

Mode lampe de poche

Appuyez une fois sur le bouton pour allumer la lumière ambiante.

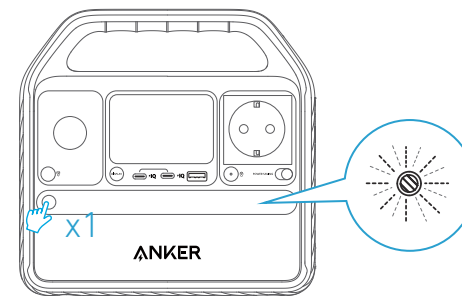

Maintenez le bouton enfoncé pendant 2 secondes pour activer le mode SOS.

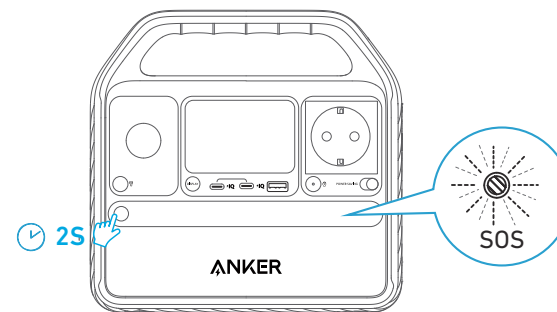

Dépannage

Réinitialisation de votre station d'alimentation

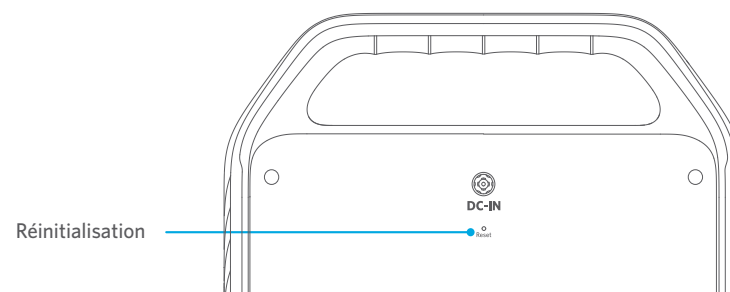

Si votre station d'alimentation ne fonctionne pas correctement, insérez un trombone ou une épingle dans le trou de réinitialisation pendant 1 seconde pour une réinitialisation d'usine. Si la station d'alimentation ne fonctionne toujours pas, veuillez contacter support@anker.com.

FAQ

Q1: Quelle est la puissance maximale de sortie du port CA ?

300 W, et si vous utilisez le port CA pour des appareils de plus de 300 W, le produit s'éteindra automatiquement.

Q2: Puis-je recharger le produit tout en chargeant des appareils connectés ?

Oui.

Q3: Ce produit peut-il alimenter un CPAP ?

Oui, mais n'oubliez pas de désactiver d'abord le mode économie d'énergie.

Q4: Ce produit perd-il automatiquement son alimentation s'il n'est pas éteint ?

Oui, lorsque la prise de courant de la voiture ou le bouton de commande CA est allumé, même si aucun appareil n'est en cours de charge, il y aura toujours une certaine consommation d'énergie à vide. Pour éviter de vider la batterie, nous vous recommandons de laisser le mode économie d'énergie activé, sauf lorsque vous chargez des appareils de faible puissance comme les appareils CPAP et les appareils photo.

Q5: Quel type de chargeur solaire peut charger ce produit ?

Tout chargeur solaire 11 V-28 V avec un connecteur mâle CC 8 mm (DC 7909).

Spécifications

Capacité de cellule	320 Wh
Entrée CC	11-28 V $\overline{\text{---}}$ 9 A (100 W max)
Sortie du chargeur de voiture	12 V $\overline{\text{---}}$ 10 A
Sortie CA	230V~,1,3A Max, 50Hz, 300W max
Sortie USB-A	5 V $\overline{\text{---}}$ 2,4 A (12W max)
Entrée USB-C 1	5 V $\overline{\text{---}}$ 3 A / 9 V $\overline{\text{---}}$ 3 A / 15 V $\overline{\text{---}}$ 3 A / 20 V $\overline{\text{---}}$ 3 A (60 W max)
Sortie USB-C 1	5 V $\overline{\text{---}}$ 3 A / 9 V $\overline{\text{---}}$ 3 A / 15 V $\overline{\text{---}}$ 3 A / 20 V $\overline{\text{---}}$ 3 A (60 W max)
Sortie USB-C 2	5V $\overline{\text{---}}$ 3A / 9V $\overline{\text{---}}$ 2,25A (20W max)
Température de décharge	-4 °F-104 °F / -20 °C-40 °C
Température de charge	32 °F-104 °F / 0 °C-40 °C
Taille	21,6*21,14*14,4 cm / 8,5*8,32*5,67 pouces
Poids net	3,9 kg / 8,6 livres

Attention



Non autorisé à bord des avions.

CONSIGNES DE SÉCURITÉ IMPORTANTES

AVERTISSEMENT - Lors de l'utilisation de ce produit, des précautions de base doivent toujours être respectées, notamment les suivantes :

Lisez toutes les instructions avant d'utiliser le produit.

- Pour réduire le risque de blessure, une surveillance étroite est nécessaire lorsque le produit est utilisé à proximité d'enfants.
- Ne pas mettre les doigts ou les mains dans le produit.
- Ne pas exposer le produit à la pluie ou à la neige.
- L'utilisation d'une alimentation ou d'un chargeur non recommandé ou vendu par le fabricant du produit peut entraîner un risque d'incendie ou de blessures corporelles.
- Pour réduire le risque d'endommager la prise et le cordon électriques, tirez sur la prise plutôt que sur le cordon lorsque vous débranchez le produit.
- Ne pas utiliser le produit au-delà de sa puissance nominale. Les sorties de surcharge supérieures à la valeur nominale peuvent entraîner un risque d'incendie ou de blessures corporelles.
- Ne pas utiliser le produit s'il est endommagé ou modifié. Les piles endommagées ou modifiées peuvent avoir un comportement imprévisible et provoquer un incendie, une explosion ou un risque de blessures corporelles.
- Ne pas utiliser le produit avec un cordon ou une fiche endommagés, ou un câble de sortie endommagé.
- Ne pas démonter le produit. Le confier à un réparateur qualifié si un entretien ou une réparation est nécessaire. Un remontage incorrect peut entraîner un risque d'incendie ou de choc électrique.
- Ne pas exposer au feu ou à des températures élevées. L'exposition au feu ou à des températures supérieures à 265 °F peut provoquer une explosion.
- Pour réduire le risque d'électrocution, débrancher le bloc d'alimentation de la prise avant d'entreprendre toute opération d'entretien.
- Faire effectuer l'entretien par un réparateur qualifié utilisant uniquement des pièces de rechange identiques. Cela permettra de garantir la sécurité du produit.
- Lors de la charge d'un appareil, le produit peut être chaud. Il s'agit d'une condition de fonctionnement normale qui ne doit pas susciter d'inquiétude.
- Lors de la charge de la batterie interne, travailler dans un endroit bien aéré et ne restreindre en aucun cas la ventilation.
- Ne pas nettoyer le produit avec des produits chimiques ou des détergents dangereux.
- Une mauvaise utilisation, une chute ou une force excessive peuvent endommager le produit.
- Lors de la mise au rebut de piles ou de batteries secondaires, garder les piles ou les batteries de systèmes électrochimiques différents séparées les unes des autres.

Instructions de stockage et d'entretien

1. Stocker le produit entre 0 °C et 40 °C. Évitez d'exposer le produit à la pluie ou d'utiliser le produit dans un environnement humide.
2. Pour préserver la durée de vie de la batterie, chargez-la à 100 % après l'avoir utilisée. Si vous envisagez de stocker votre centrale, rechargez-la à 100 % tous les 3 mois.
3. Garder le produit sur une surface plane lors de l'utilisation, du chargement et du stockage..

Déclaration de conformité

Par la présente, Anker Innovations Limited déclare que ce produit de type A1721 est conforme aux directives 2014/35/EU, 2014/30/EU et 2011/65/EU. Le texte intégral de la déclaration de conformité pour l'UE est disponible à l'adresse internet suivante :

<https://www.anker.com>



Ce symbole indique que ce produit ne doit pas être traité comme un déchet ménager. Au lieu de cela, il doit être remis au point de collecte applicable pour le recyclage des équipements électriques et électroniques.



FR

Cet appareil,
ses accessoires,
piles et cordons
se recyclent

À DÉPOSER
EN MAGASIN



À DÉPOSER
EN DÉCHÈTERIE



Points de collecte sur www.quefairedemesdechets.fr
Privilégiez la réparation ou le don de votre appareil !

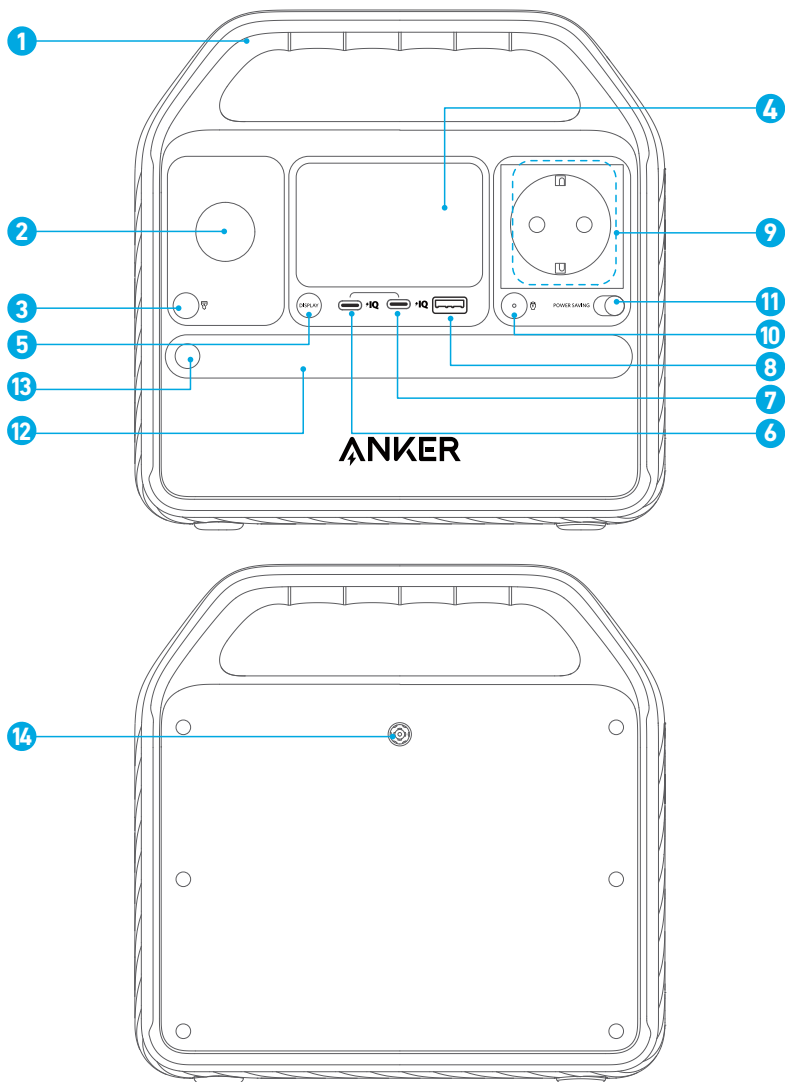

- 1 Impugnatura
- 2 Presa per auto
- 3 Pulsante di accensione/spengimento presa per auto
- 4 Schermo LCD
- 5 Pulsante di accensione/spengimento dello schermo LCD
- 6 Porta di ingresso/uscita USB-C
- 7 Porta di uscita USB-C
- 8 Porta di uscita USB-A
- 9 Porta di uscita CA
- 10 Pulsante di attivazione/disattivazione della porta di uscita CA
- 11 Pulsante di accensione/spengimento della modalità di risparmio energetico
- 12 Luce ambientale
- 13 Pulsante di accensione/spengimento della luce ambientale
- 14 Porta di ingresso CC

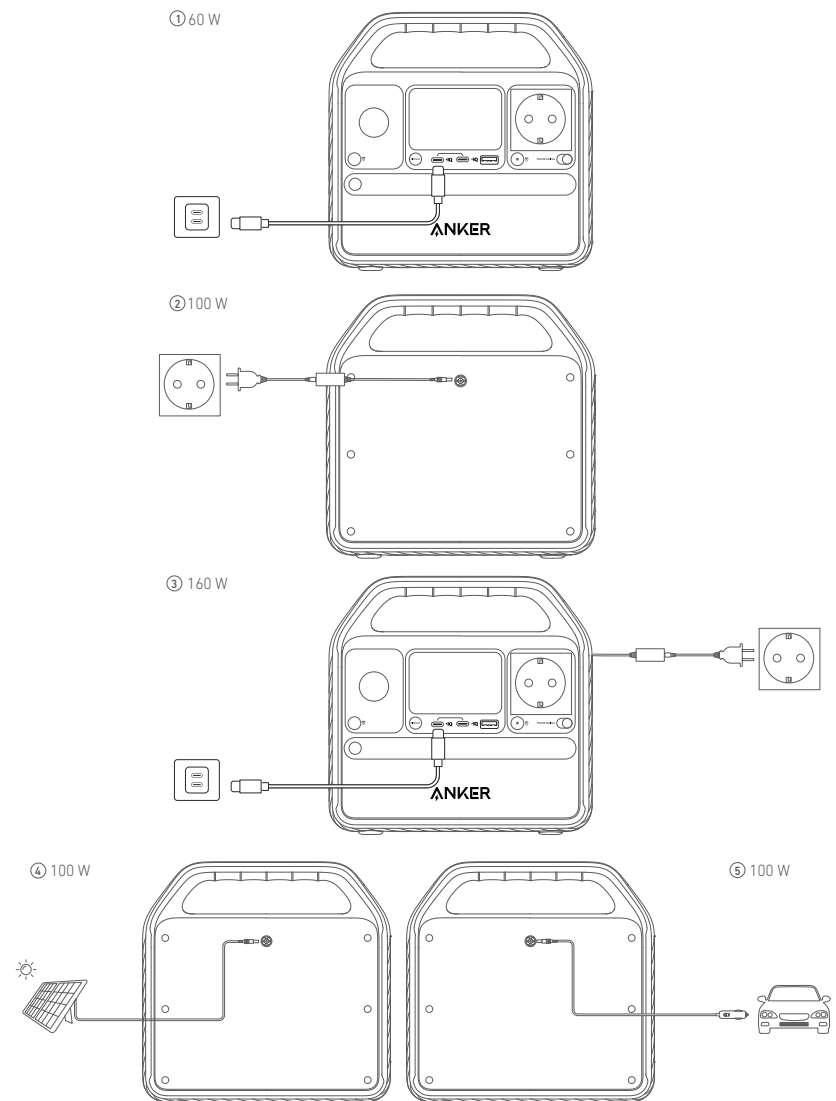

- Caricare completamente il prodotto prima di utilizzarlo per la prima volta.
- Quando la stazione di alimentazione portatile scenda a un livello di batteria dell'1%, gli indicatori di batteria rimanente lampeggeranno come promemoria per la ricarica.

Alimentazione dei tuoi dispositivi

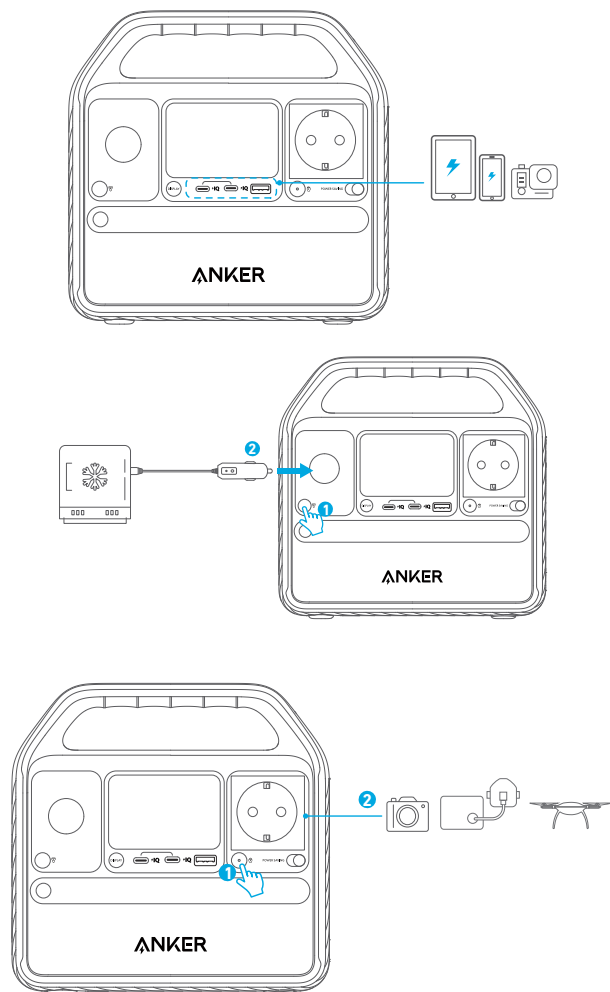

1. Le porte USB-A e USB-C supportano la ricarica. I dispositivi collegati inizieranno a caricarsi automaticamente; al momento di scolgarli si spegneranno automaticamente.
2. La presa dell'auto e la porta di uscita CA non supportano la ricarica. Utilizzare i pulsanti di accensione/spengimento corrispondenti per accenderli prima della ricarica.
3. Per evitare di scaricare la batteria, si consiglia di mantenere attiva la modalità di risparmio energetico, tranne quando si caricano dispositivi a bassa potenza come macchine CPAP e fotocamere.

Modalità di risparmio energetico

L'attivazione della modalità di risparmio energetico impedisce lo spreco di energia spegnendo automaticamente la Power Station una volta che tutti i dispositivi sono completamente carichi. La disattivazione della modalità di risparmio energetico consentirà una ricarica stabile per un periodo prolungato, ad esempio per la fotografia time-lapse o per dormire con una macchina CPAP.

Guida allo schermo LCD

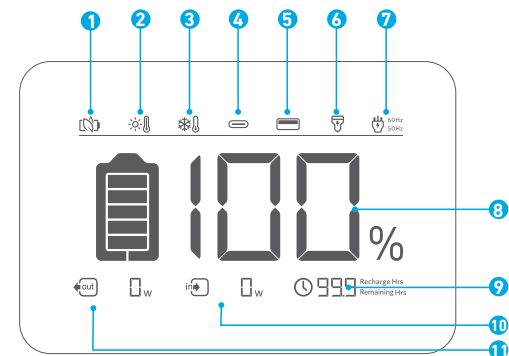

Modalità di risparmio energetico



Avviso di alta temperatura

- Quando viene visualizzata questa icona, interrompere l'utilizzo del prodotto e lasciarlo raffreddare finché l'icona non scompare.



Avviso di bassa temperatura

- Quando viene visualizzata questa icona, interrompere l'utilizzo del prodotto finché l'icona non scompare.



Porta di ingresso/uscita USB-C



Uscita USB-A



Ricarica per auto



Ricarica CA e frequenza voltaggio



Batteria rimanente



Batteria rimanente in ore



Potenza della corrente in ingresso



Potenza della corrente in uscita

Modalità torcia

Premere il pulsante una volta per accendere la luce ambientale.

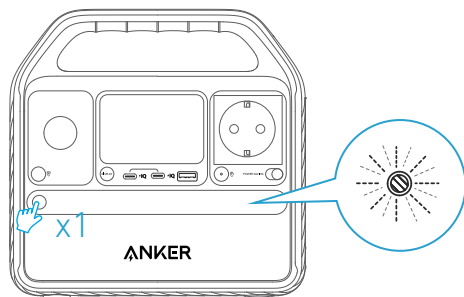

Tenere premuto il pulsante per 2 secondi per attivare la modalità SOS.

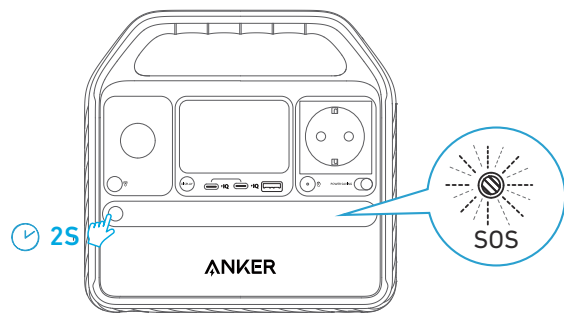

Risoluzione dei problemi

Ripristino della stazione di alimentazione

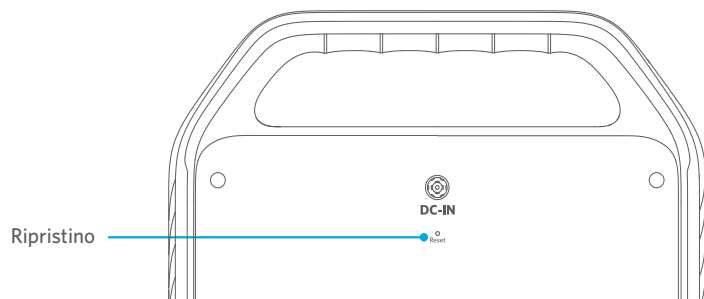

Se la stazione di alimentazione non funziona correttamente, inserisci una graffetta o uno spillo nel foro di ripristino per 1 secondo, al fine di ripristinare le impostazioni di fabbrica. Se la stazione di alimentazione continua a non funzionare, contatta support@anker.com.

Domande frequenti

D1: Qual è la potenza massima in uscita dalla porta CA?

300 W; se si utilizza la porta CA per dispositivi superiori a 300 W, il prodotto si spegne automaticamente.

D2: Posso ricaricare il prodotto mentre è in corso la ricarica di dispositivi collegati?

Sì.

D3: Questo prodotto può alimentare un CPAP?

Sì, ma è necessario disattivare prima la modalità di risparmio energetico.

D4: Questo prodotto perde automaticamente l'alimentazione se non viene spento?

Sì, quando la presa dell'auto o il pulsante di controllo CA è acceso, pur senza alcun dispositivo in carica, vi è sempre una certa quantità di consumo energetico a vuoto. Per evitare di scaricare la batteria, si consiglia di mantenere attiva la modalità di risparmio energetico, tranne quando si caricano dispositivi a bassa potenza come macchine CPAP e fotocamere.

D5: Che tipo di caricabatterie solare può ricaricare questo prodotto?

Qualsiasi caricatore solare da 11-28 V con connettore maschio DC 7909 da 8 mm.

Specifiche

Capacità cellulare	320 Wh
Ingresso CC	11-28 V $\overline{\text{---}}$ 9 A (100 W max)
Uscita caricabatteria per auto	12 V $\overline{\text{---}}$ 10 A
Uscita CA	230V-,1,3A Max, 50Hz, 300W max
Uscita USB-A	5 V $\overline{\text{---}}$ 2,4 A(12W max)
Ingresso USB-C 1	5 V $\overline{\text{---}}$ 3 A/ 9 V $\overline{\text{---}}$ 3 A/ 15 V $\overline{\text{---}}$ 3 A/20 V $\overline{\text{---}}$ 3 A (60 W max)
Uscita USB-C 1	5 V $\overline{\text{---}}$ 3 A/ 9 V $\overline{\text{---}}$ 3 A/ 15 V $\overline{\text{---}}$ 3 A/20 V $\overline{\text{---}}$ 3 A (60 W max)
Uscita USB-C 2	5V $\overline{\text{---}}$ 3A/ 9V $\overline{\text{---}}$ 2,25A (20W max)
Temperatura di scarica	-4 °F - 104 °F / -20 °C - 40 °C
Temperatura di ricarica	32 °F - 104 °F / 0 °C - 40 °C
Dimensione	21,6*21,14*14,4 cm/ 8,5*8,32*5,67 pollici
Peso netto	3,9 kg/8,6 libbre

Attenzione



Non consentito sugli aerei.

ISTRUZIONI IMPORTANTI SULLA SICUREZZA

AVVERTENZA - Quando si utilizza questo prodotto, dovrebbero essere sempre prese precauzioni di base, tra cui: Leggere tutte le istruzioni prima di utilizzare il prodotto.

- Per ridurre il rischio di lesioni, è necessaria un'attenta supervisione quando il prodotto viene utilizzato in presenza di bambini.
- Non inserire le dita o le mani nel prodotto.
- Non esporre il prodotto a pioggia o neve.
- L'uso di un alimentatore o di un caricabatterie non consigliato o venduto dal produttore del prodotto può comportare un rischio di incendio o lesioni alle persone.
- Per ridurre il rischio di danni alla spina e al cavo, scollegare sempre il prodotto tirando la spina e non il cavo.
- Non utilizzare il prodotto oltre la sua potenza nominale. Un sovraccarico in uscita superiore alla potenza nominale può comportare il rischio di incendio o lesioni alle persone.
- Non utilizzare il prodotto se danneggiato o modificato. Le batterie danneggiate o modificate possono presentare un comportamento imprevedibile che potrebbe causare incendio, esplosione o rischio di lesioni.
- Non utilizzare il prodotto se il cavo di alimentazione, la spina o un cavo di uscita sono danneggiati.
- Non smontare il prodotto. Portarlo a un tecnico qualificato in caso sia necessaria assistenza o riparazione. Un riassetto errato può comportare rischio di incendio o scossa elettrica.
- Non esporre al fuoco o a temperature elevate. L'esposizione al fuoco o a temperature superiori a 130°C può causare esplosioni.
- Per ridurre il rischio di scosse elettriche, scollegare l'alimentatore dalla presa prima di eseguire qualsiasi intervento di assistenza secondo istruzioni.
- Far eseguire la manutenzione da un tecnico di riparazione qualificato utilizzando solo parti di ricambio identiche. Ciò garantirà la sicurezza del prodotto.
- Quando si carica un dispositivo, il prodotto potrebbe risultare caldo: è una condizione operativa normale che non rappresenta motivo di preoccupazione.
- Ricaricare la batteria interna in un'area ben ventilata e non limitare in alcun modo la ventilazione.
- Non pulire il prodotto con agenti chimici nocivi o detergenti.
- L'uso improprio, la caduta o una forza eccessiva possono causare danni al prodotto.
- Quando si smaltiscono le celle o le batterie secondarie, tenere separati gli elementi di diversi sistemi elettrochimici.

Istruzioni per la conservazione e la manutenzione

1. Conservare il prodotto a una temperatura compresa tra 32°F e 104°F (tra 0°C e 40°C). Evitare di esporre il prodotto alla pioggia o di utilizzarlo in un ambiente umido.
2. Per preservare la durata della batteria, caricala fino al 100% dopo l'uso. Se prevedi di riporre la stazione di alimentazione, ricaricala al 100% ogni 3 mesi.
3. Tenere il prodotto su una superficie piana durante l'utilizzo, la ricarica e la conservazione.

Dichiarazione di conformità

Con la presente, Anker Innovations Limited dichiara che il tipo di prodotto A1721 è conforme alle Direttive 2014/35/EU, 2014/30/EU e 2011/65/EU. Il testo completo della dichiarazione di conformità UE è disponibile al seguente indirizzo Internet: <https://www.anker.com>

 Questo simbolo indica che il presente prodotto non deve essere trattato come rifiuto domestico. Dovrà invece essere consegnato al punto di raccolta applicabile per il riciclaggio di apparecchiature elettriche ed elettroniche.

Visão geral

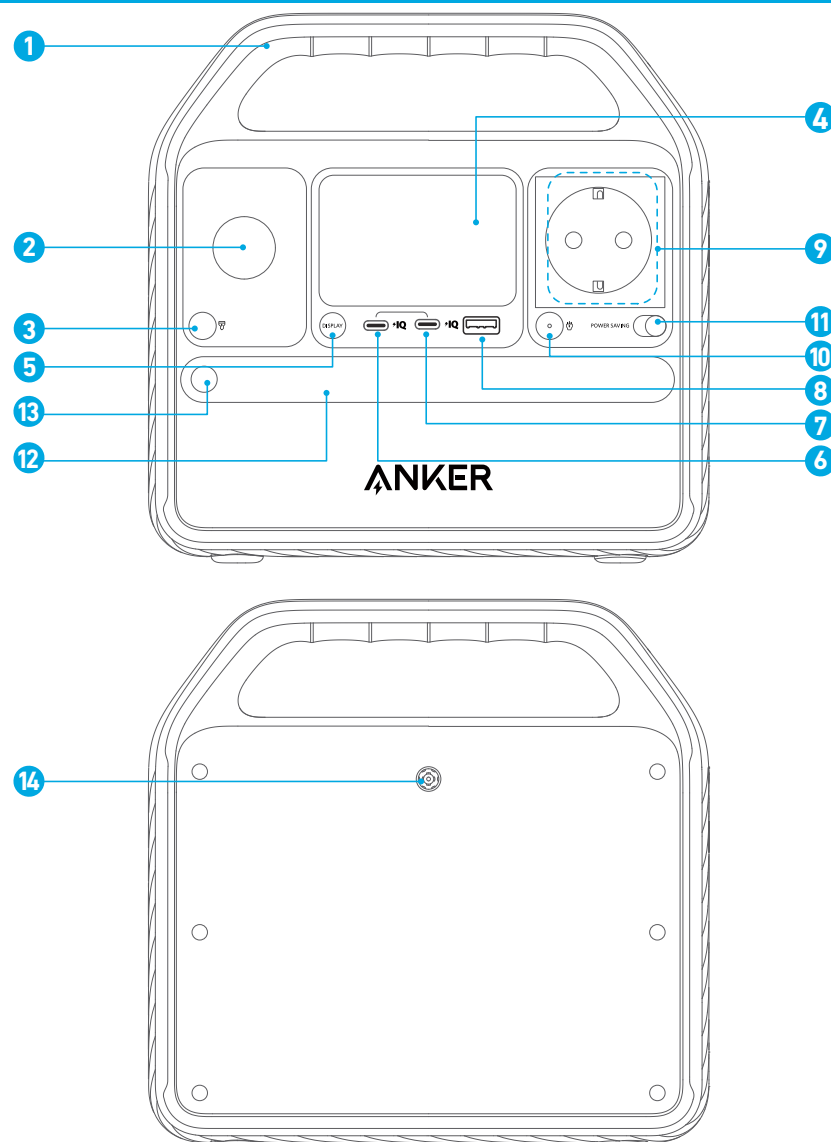

- | | |
|---|---------------------------------------|
| 1 Manopla | 2 Soquete para carro |
| 3 Botão liga/desliga soquete para carro | 4 Tela LCD |
| 5 Botão liga/desliga tela LCD | 6 Porta de entrada/saída USB-C |
| 7 Porta de saída USB-C | 8 Porta de saída USB-A |
| 9 Porta de saída AC | |
| 10 Botão liga/desliga porta de saída AC | |
| 11 Botão ativar/desativar modo de economia de energia | |
| 12 Luz ambiente | 13 Botão liga/desliga da luz ambiente |
| 14 Porta de entrada DC | |

Recarregar a sua bateria

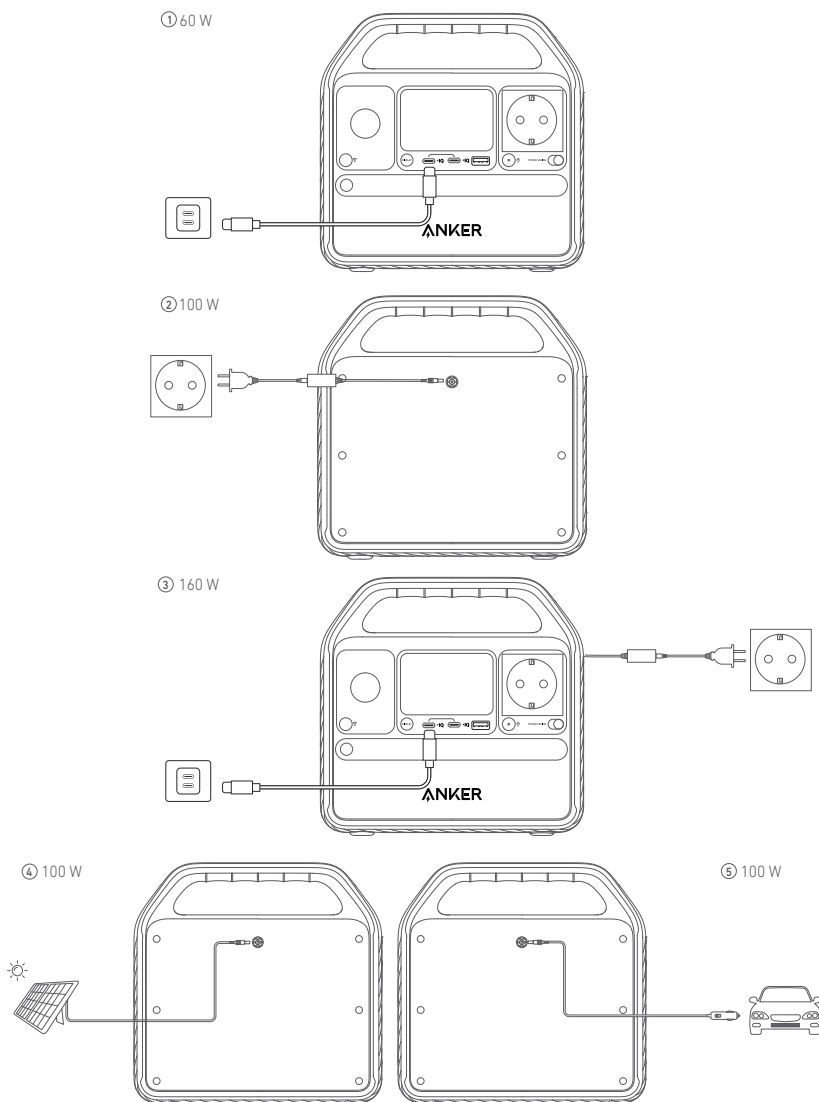

- Carregue totalmente o produto antes de usar pela primeira vez.
- Quando sua estação de energia portátil tiver apenas 1% de bateria restante, os indicadores de bateria restante piscarão para lembrá-lo de recarregar o dispositivo.

Ligar os seus dispositivos

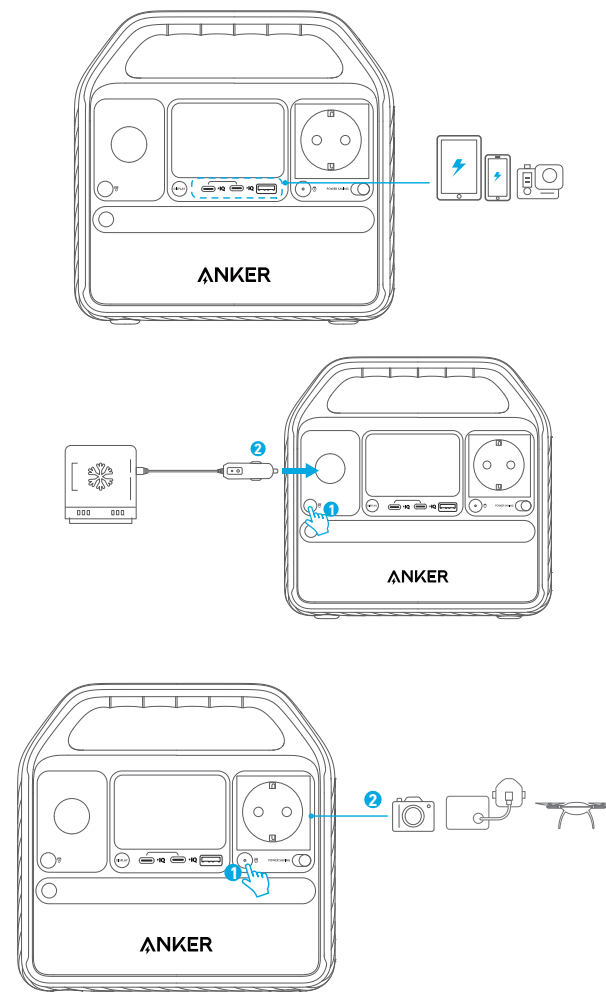

- 1.As portas USB-A e USB-C podem ser usadas para conectar e carregar. Quando os dispositivos são conectados, eles começam a carregar automaticamente. Quando os dispositivos são desconectados, eles desligam automaticamente.
- 2.O soquete para carro e a porta de saída CA não são compatíveis com conectar e carregar. Use os botões liga/desliga correspondentes para ligá-los antes de carregar.
- 3.Para evitar o esgotamento da bateria, recomendamos manter o modo de economia de energia ativado, exceto quando estiver carregando dispositivos de baixo consumo de energia, como máquinas CPAP e câmeras.

Modo de poupança de energia

A ativação do modo de poupança de energia evita o desperdício energético ao desativar automaticamente a bateria quando todos os dispositivos estiverem totalmente carregados. A desativação do modo de poupança de energia proporciona um carregamento estável durante períodos prolongados, como quando capta fotografias do tipo "time-lapse" ou usa um aparelho CPAP durante o sono.

Guia da tela LCD

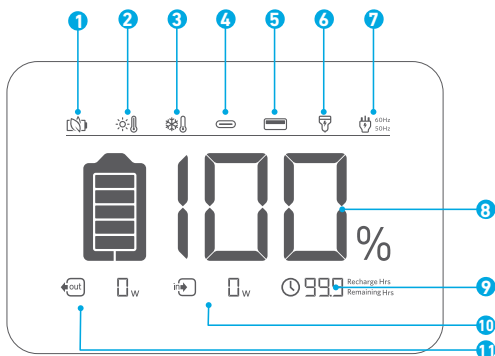

Modo de economia de energia



Alerta de temperatura alta

• Quando este ícone for mostrado, pare de usar o produto e aguarde-o esfriar até que o ícone desapareça.



Alerta de temperatura baixa

• Quando este ícone for mostrado, pare de usar o produto até que o ícone desapareça.



Porta de entrada/saída USB-C



Saída USB-A



Carregamento no carro



Carregamento CA e frequência de voltagem



Bateria restante



Bateria restante em horas



Potência de entrada atual



Potência de saída atual

Modo lanterna

Pressione o botão uma vez para ligar a luz ambiente.

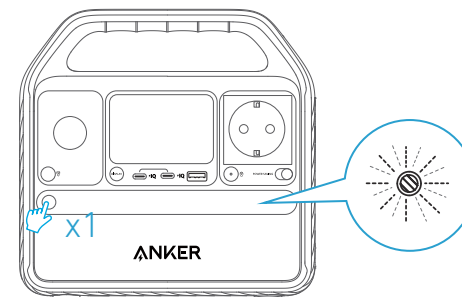

Segure o botão por 2 segundos para ligar o modo SOS.

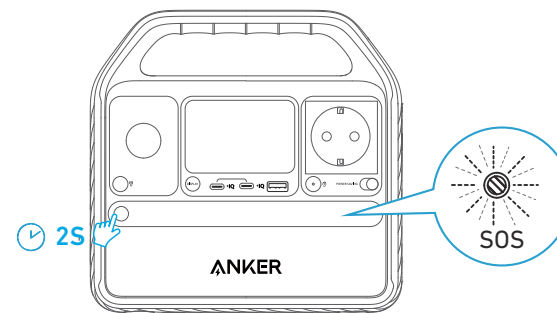

Resolução de problemas

Repor a bateria

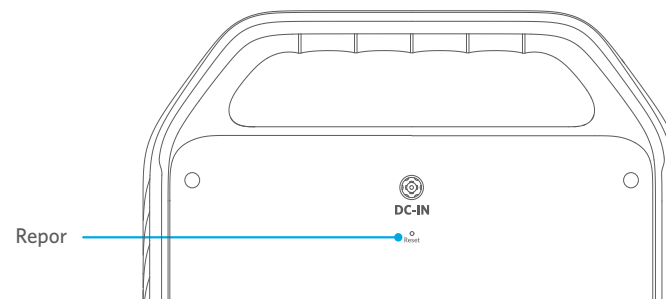

Se a bateria não estiver a funcionar corretamente, introduza um clipe ou um pino no orifício de reposição durante 1 segundo para restaurar as definições de fábrica. Se a bateria continuar sem funcionar, contacte support@anker.com

Perguntas frequentes

P1: Qual é a potência máxima de saída da porta AC?

300W, e, se você usar a porta AC para dispositivos maiores que 300W, o produto desligará automaticamente.

P2: Posso recarregar o produto enquanto carrego os dispositivos conectados?

Sim.

P3: Este produto pode alimentar um CPAP?

Sim, mas não se esqueça de primeiro desligar o modo de economia de energia.

P4: Este produto perderá energia automaticamente se não for desligado?

Sim, quando o soquete do carro ou o botão de controle AC são ligados, mesmo que nenhum dispositivo esteja sendo carregado, ainda haverá certo consumo de energia sem carga. Para evitar o esgotamento da bateria, recomendamos manter o modo de economia de energia ativado, exceto ao carregar dispositivos de baixo consumo de energia, como máquinas CPAP e câmeras.

P5: Que tipo de carregador solar pode carregar este produto?

Qualquer carregador solar de 11 V a 28 V com um conector macho CC de 8 mm (DC 7909).

Especificações

Capacidade da célula	320 Wh
Entrada CC	11-28 V $\overline{\text{---}}$ 9 A (100 W máx.)
Saída do carregador do carro:	12 V $\overline{\text{---}}$ 10 A
Saída CA	230V~,1,3A máx, 50Hz, 300W máx
Saída USB-A	5 V $\overline{\text{---}}$ 2,4 A (12W máx.)
Entrada USB-C 1	5 V $\overline{\text{---}}$ 3 A/ 9 V $\overline{\text{---}}$ 3 A/ 15 V $\overline{\text{---}}$ 3 A/20 V $\overline{\text{---}}$ 3 A (60 W máx.)
Saída USB-C 1	5 V $\overline{\text{---}}$ 3 A/9 V $\overline{\text{---}}$ 3 A/15 V $\overline{\text{---}}$ 3 A/20 V $\overline{\text{---}}$ 3 A (60 W máx.)
Saída USB-C 2	5V $\overline{\text{---}}$ 3A/ 9V $\overline{\text{---}}$ 2,25A (20W máx.)
Temperatura de descarregamento	-4 °F - 104 °F / -20 °C - 40 °C
Temperatura de carregamento	32 °F - 104 °F / 0 °C - 40 °C
Tamanho	21,6*21,14*14,4 cm/ 8,5*8,32*5,67 pol.
Peso líquido	3,9 kg/8,6 lbs

Atenção



Não permitido em aeronaves.

INSTRUÇÕES DE SEGURANÇA IMPORTANTES

AVISO - Ao usar este produto, precauções básicas devem sempre ser seguidas, incluindo as seguintes: Leia todas as instruções antes de usar o produto.

- Para reduzir o risco de lesões, será necessária supervisão cuidadosa quando o produto for usado perto de crianças.
- Não coloque os dedos ou as mãos dentro do produto.
- Não exponha o produto à chuva ou à neve.
- O uso de fontes de alimentação ou carregadores não recomendados ou não vendidos pelo fabricante do produto pode resultar em risco de incêndio ou ferimentos.
- Para reduzir o risco de danos ao plugue e ao cabo elétrico, puxe o plugue em vez do cabo ao desconectar o produto.
- Não use o produto além de sua capacidade nominal. As saídas de sobrecarga acima da capacidade nominal podem resultar em risco de incêndio ou ferimentos às pessoas.
- Não use o produto se ele estiver danificado ou tiver sido modificado. Baterias danificadas ou modificadas podem apresentar comportamento imprevisível, resultando em incêndio, explosão ou risco de ferimentos.
- Não opere o produto com um cabo ou plugue danificado ou com um cabo de saída danificado.
- Não desmonte o produto. Em caso de necessidade de manutenção ou reparos, procure um técnico qualificado. A remontagem incorreta pode resultar em risco de incêndio ou choque elétrico.
- Não exponha ao fogo ou a temperaturas elevadas. A exposição ao fogo ou temperaturas acima de 265 °F pode causar uma explosão.
- Para reduzir o risco de choque elétrico, desconecte o pacote de força da tomada antes de tentar qualquer manutenção instruída.
- A manutenção deve ser realizada por um técnico qualificado usando apenas peças de reposição idênticas. Isso garantirá que a segurança do produto seja mantida.
- Ao carregar um dispositivo, o produto pode esquentar. Isso é uma condição operacional normal e não deve ser motivo de preocupação.
- Ao carregar a bateria interna, trabalhe em uma área bem ventilada e não restrinja a ventilação de forma alguma.
- Não limpe o produto com produtos químicos ou detergentes nocivos.
- Uso indevido, queda ou força excessiva podem causar danos ao produto.
- Ao descartar células ou baterias secundárias, mantenha as células ou baterias de diferentes sistemas eletroquímicos separadas umas das outras.

Instruções de armazenamento e manutenção

1. Armazene o produto entre 0 °C-40 °C. Evite expor o produto à chuva ou utilizá-lo em ambientes húmidos.
2. Para preservar a duração da bateria, carregue-a até 100% após a utilização. Se planeia armazenar a bateria, carregue-a até 100% a cada 3 meses.
3. Mantenha o produto sobre uma superfície plana durante a utilização, o carregamento e o armazenamento.

Declaração de conformidade

Por meio deste, a Anker Innovations Limited declara que o tipo de produto A1721 está em conformidade com as Diretivas 2014/35/EU, 2014/30/EU e 2011/65/EU. O texto completo da declaração de conformidade da UE está disponível no seguinte endereço de Internet:

<https://www.anker.com>



Este símbolo indica que este produto não deve ser tratado como lixo doméstico. Em alternativa, deve ser entregue no ponto de recolha aplicável para reciclagem de equipamento elétrico e eletrónico.

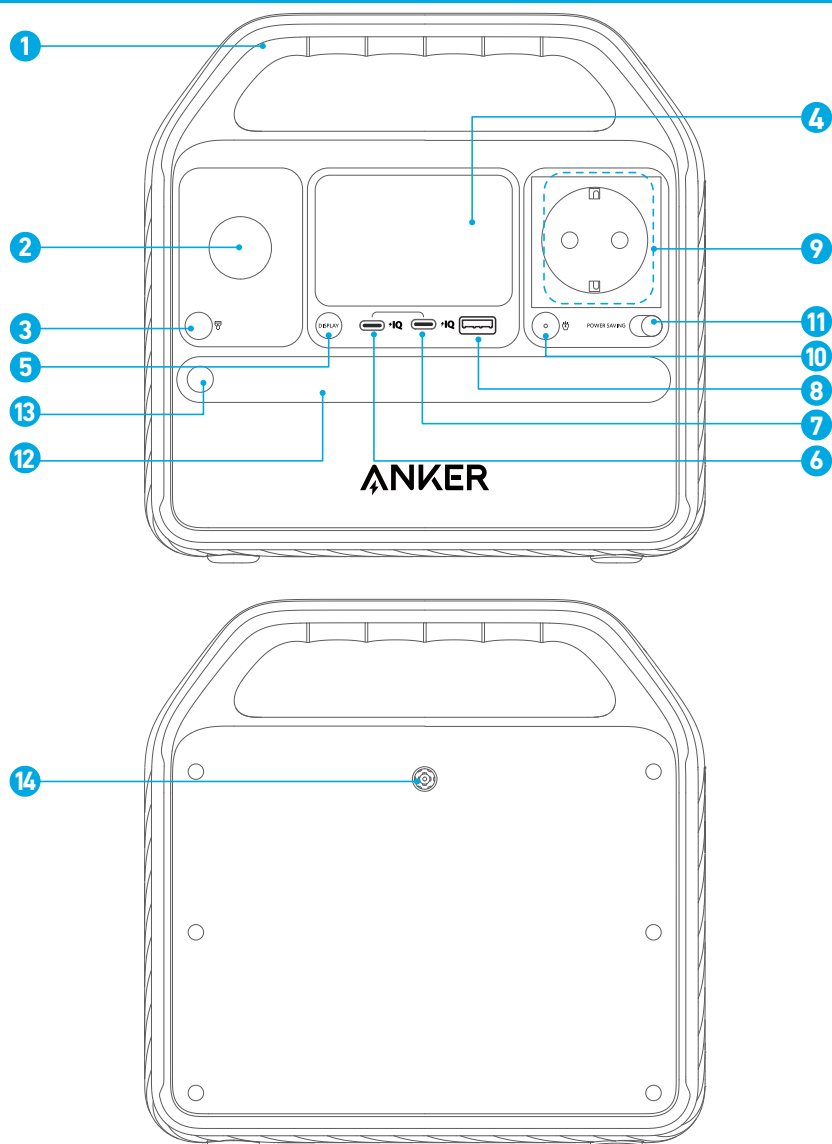

- 1 Ручка
- 2 Автомобильная розетка
- 3 Кнопка включения/выключения автомобильной розетки
- 4 ЖК-экран
- 5 Кнопка включения/выключения ЖК-экрана
- 6 Входной/выходной разъем USB-C
- 7 Выходной разъем USB-C
- 8 Выходной разъем USB-A
- 9 Выходной разъем переменного тока
- 10 Кнопка включения/выключения выходного разъема переменного тока
- 11 Переключатель режима энергосбережения
- 12 Внешняя подсветка
- 13 Кнопка включения/выключения внешней подсветки
- 14 Входной разъем постоянного тока

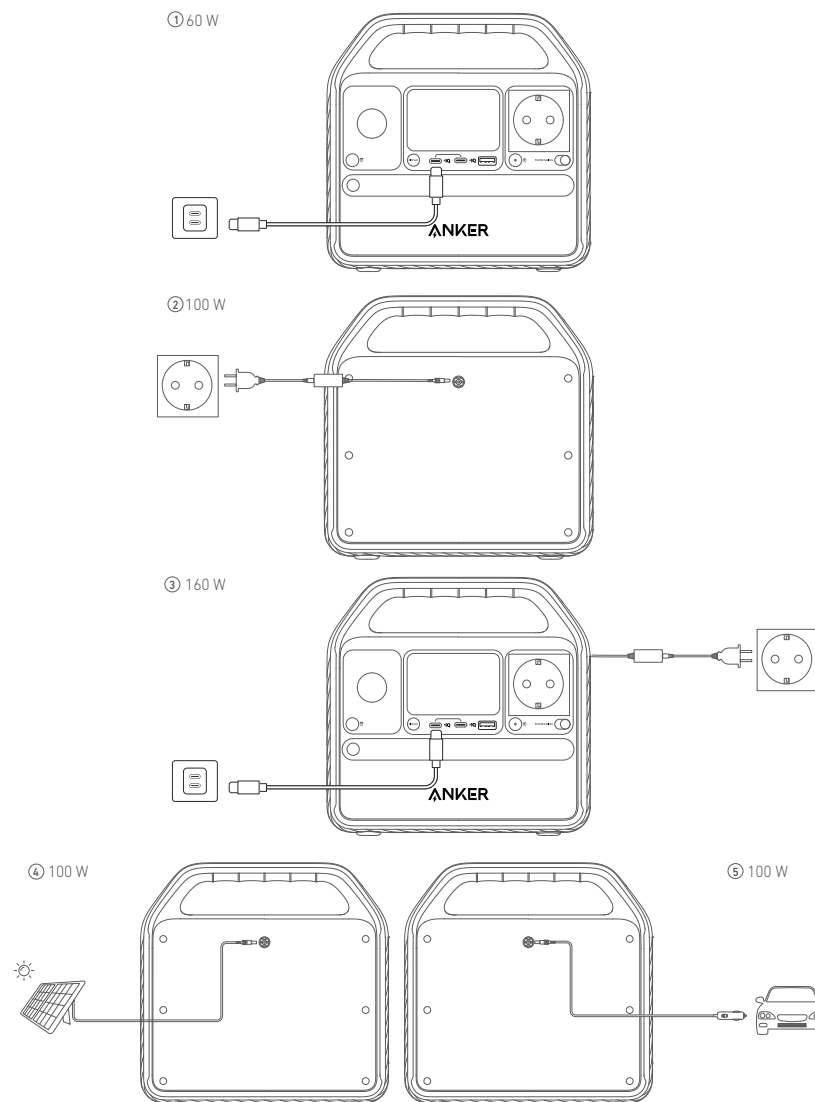

- Полностью зарядите изделие перед первым использованием.
- Когда уровень заряда портативной электростанции опустится до 1%, начнут мигать индикаторы заряда, напоминающие о необходимости подзарядки.

Подача питания на устройства

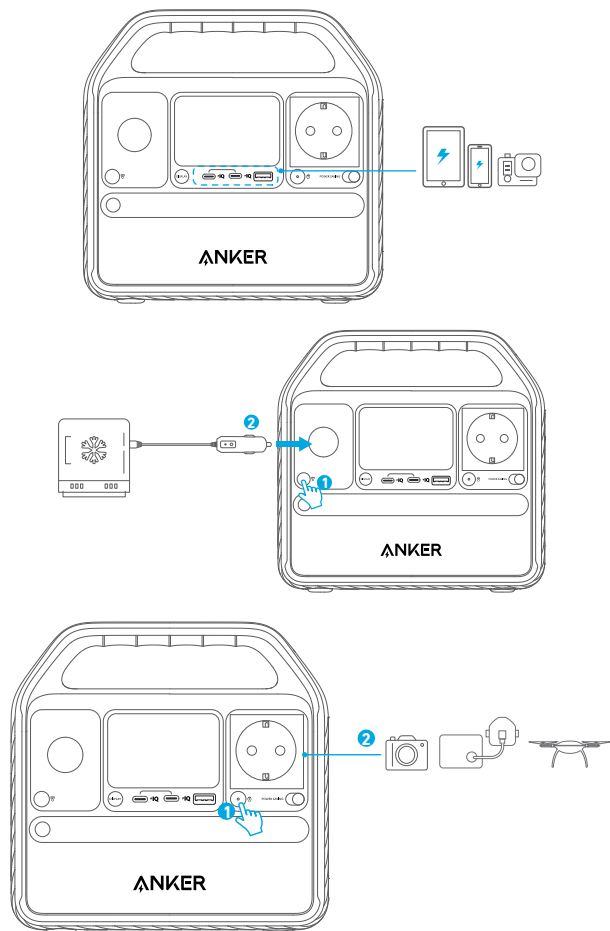

1. Разъемы USB-A и USB-C поддерживают режим зарядки при подключении. При подключении устройств зарядка запускается автоматически; после отключения устройств от разъемов они автоматически отключаются.

2. Автомобильная розетка и выходной разъем переменного тока не поддерживают функцию зарядки при подключении. Для запуска зарядки необходимо использовать соответствующие кнопки включения/выключения.

3. Для экономного расходования заряда батареи рекомендуется всегда использовать режим энергосбережения, кроме случаев, когда вы заряжаете маломощные устройства, такие как СИПАП-аппараты и камеры.

Режим энергосбережения

Включение режима энергосбережения предотвращает потерю энергии за счет автоматического выключения электростанции после полной зарядки всех устройств.

Отключение режима энергосбережения обеспечит стабильную зарядку в течение длительного периода времени, например для покадровой фотосъемки или сна с СИПАП-аппаратом.

Указания по использованию ЖК-экрана

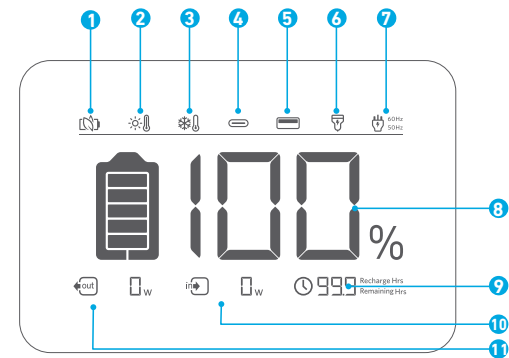

Режим энергосбережения



Предупреждение о высокой температуре

- Когда появляется этот значок, необходимо прекратить использование устройства и дать ему остыть до исчезновения значка.



Предупреждение о низкой температуре

- Когда отображается этот значок, необходимо прекратить использование устройства до исчезновения значка.



Входной/выходной разъем USB-C



Выход USB-A



Автомобильное зарядное устройство



Зарядка AC и частота напряжения



Оставшийся заряд аккумулятора



Оставшийся заряд аккумулятора в часах



Текущая входная мощность



Текущая выходная мощность

Режим фонарика

Нажмите кнопку один раз для включения внешней подсветки.

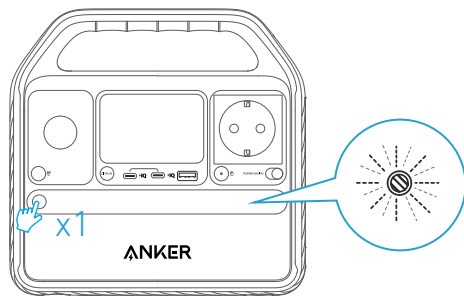

Нажмите кнопку и удерживайте ее в течение 2 секунд, чтобы включить режим SOS.

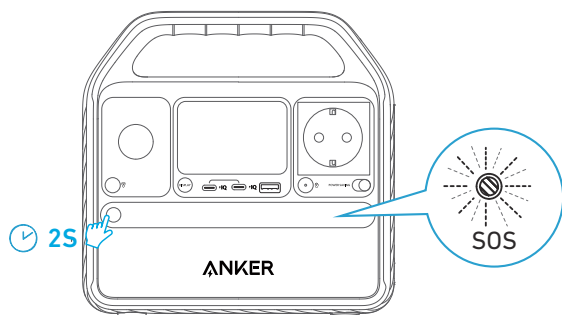

Поиск и устранение неисправностей

Сброс электростанции

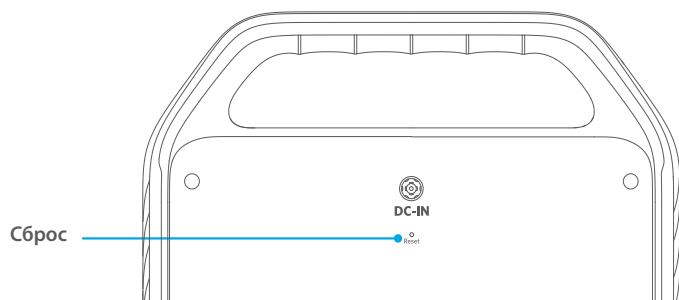

Если электростанция работает некорректно, вставьте скрепку или булавку в отверстие сброса на 1 секунду, чтобы сбросить настройки. Если электростанция по-прежнему не работает, обратитесь в поддержку по адресу support@anker.com.

Часто задаваемые вопросы

Вопрос 1: Какая максимальная выходная мощность разъема переменного тока?

300 Вт. При использовании разъема переменного тока для устройств мощностью более 300 Вт аппарат автоматически выключится.

Вопрос 2: Могу ли я заряжать изделие одновременно с зарядкой подключенных устройств?

Да.

Вопрос 3: Можно ли использовать это устройство для зарядки СИПАП-аппаратов?

Да, но не забудьте предварительно отключить режим энергосбережения.

Вопрос 4: Будет ли изделие терять заряд, если его принудительно не отключить?

Да, при включенной автомобильной розетке или при нажатой кнопке питания переменного тока, даже при отсутствии заряжаемых устройств, некоторое количество энергии будет потребляться в холостом режиме. Для экономного расходования заряда батареи рекомендуется всегда использовать режим энергосбережения, кроме случаев, когда вы заряжаете маломощные устройства, такие как СИПАП-аппараты и камеры.

Вопрос 5: Какое зарядное устройство на солнечных панелях может заряжать этот продукт?

Любое зарядное устройство на солнечных панелях напряжением 11 В–28 В со штекером DC, 8 мм (DC 7909).

Технические характеристики

Емкость аккумулятора	320 Вт·ч
Вход постоянного тока	11–28 В $\overline{\text{---}}$ 9 А (макс. 100 Вт)
Выход автомобильного зарядного устройства	12 В $\overline{\text{---}}$ 10 А
Выход переменного тока	230В~, макс. 1,3 А, 50 Гц, макс. 300 Вт
Выход USB-A	5 В $\overline{\text{---}}$ 2,4 А (макс. 12 Вт)
Вход USB-C 1	5 В $\overline{\text{---}}$ 3 А / 9 В $\overline{\text{---}}$ 3 А / 15 В $\overline{\text{---}}$ 3 А / 20 В $\overline{\text{---}}$ 3 А (макс. 60 Вт)
Выход USB-C 1	5 В $\overline{\text{---}}$ 3 А / 9 В $\overline{\text{---}}$ 3 А / 15 В $\overline{\text{---}}$ 3 А / 20 В $\overline{\text{---}}$ 3 А (макс. 60 Вт)
Выход USB-C 2	5 В $\overline{\text{---}}$ 3 А / 9 В $\overline{\text{---}}$ 2,25 А (макс. 20 Вт)
Температура разрядки	от -20 до 40 °C
Температура зарядки	от 0 до 40 °C
Размер	21,6 * 21,14 * 14,4 см
Масса нетто	3,9 кг

Внимание



Не допускается на борту самолетов.

ВАЖНЫЕ ИНСТРУКЦИИ ПО ТЕХНИКЕ БЕЗОПАСНОСТИ

ПРЕДУПРЕЖДЕНИЕ. При использовании данного изделия всегда следует соблюдать основные меры предосторожности, включая следующие:

Перед использованием изделия изучите все инструкции.

- Чтобы снизить риск травм, внимательно следите за детьми, если изделие используется рядом с ними.
- Не засовывайте пальцы или руки в изделие.
- Не подвергайте изделие воздействию дождя или снега.
- Использование блока питания или зарядного устройства, не рекомендованного производителем изделия либо проданного не им, может привести к возгоранию или травмам.
- Чтобы уменьшить риск повреждения электрической вилки и шнура, при отсоединении изделия тяните за вилку, а не за шнур.
- Не используйте изделие для питания устройств, которым требуется мощность, превышающая его номинальную. Перегрузка на выходе может привести к возгоранию или травмам.
- Не допускается использование изделия в случае его повреждения или внесения изменений в конструкцию. Поврежденные или измененные аккумуляторы могут работать непредсказуемо и могут загореться, взорваться или привести к травмам.
- Не используйте продукт в случае повреждения шнура, вилки или выходного кабеля.
- Не разбирайте изделие. Если требуется обслуживание или ремонт, обратитесь к квалифицированному техническому специалисту. Неправильная сборка может привести к возгоранию или поражению электрическим током.
- Не подвергайте воздействию огня или высокой температуры. Воздействие огня или температуры выше 265 °F может вызвать взрыв.
- Для уменьшения риска поражения электрическим током отключайте блок питания от розетки перед проведением любого требуемого обслуживания.
- Обслуживание и ремонт должны проводиться квалифицированным техническим специалистом с использованием только идентичных запасных частей. Это обеспечит безопасную работу изделия.
- Во время зарядки устройство может нагреваться, это нормальное рабочее состояние и не должно вызывать беспокойства.
- Зарядку внутренней батареи следует проводить в хорошо проветриваемом помещении, не допускается любое ограничение вентиляции.
- Не используйте для очистки изделия вредные химические вещества и моющие средства.
- Неправильное использование изделия, его падение или приложение к нему чрезмерного усилия может привести к его повреждению.
- При утилизации аккумуляторных элементов или аккумуляторов отделяйте элементы или аккумуляторы разных электрохимических систем друг от друга.

Указания по хранению и обслуживанию

1. Храните изделие при температуре от 0 °C до 40 °C. Избегайте попадания изделия под дождь или его использования во влажной среде.
2. Чтобы продлить срок службы батареи, заряжайте ее до 100 % после использования. Если вы планируете поместить электростанцию на хранение, заряжайте ее до 100 % каждые 3 месяца.
3. При использовании, зарядке и хранении изделие должно быть установлено на ровной поверхности.

Декларация о соответствии

Настоящим Anker Innovations Limited заявляет, что тип продукта A1721 соответствует Директивам 2014/35/EU, 2014/30/EU и 2011/65/EU. Полный текст декларации о соответствии для ЕС можно найти на следующем веб-сайте:

<https://www.anker.com>



Этот символ означает, что прибор нельзя утилизировать вместе с бытовыми отходами. Вместо этого его необходимо передать в соответствующий пункт сбора для переработки электрического и электронного оборудования.

Genel Bakış

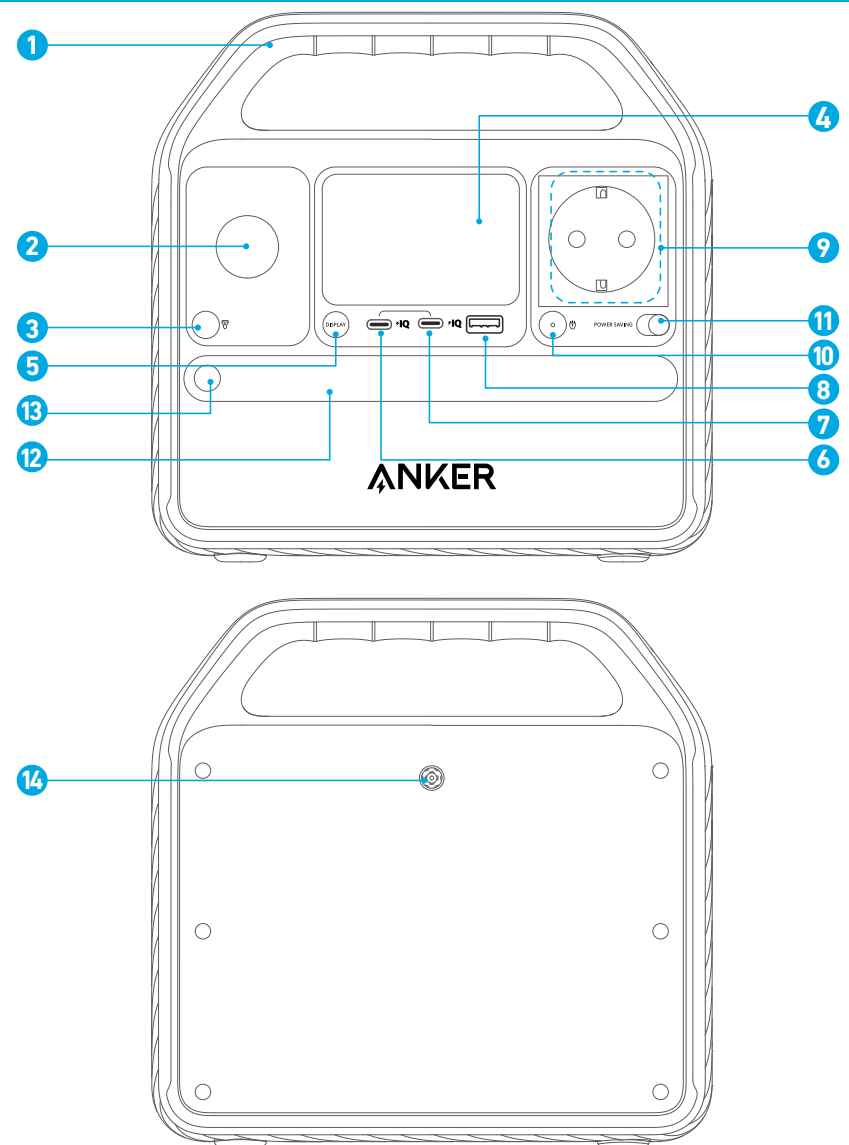

- 1 Tutma Yeri
- 2 Araç Soketi
- 3 Araç Soketi Açma/Kapama Düğmesi
- 4 LCD Ekran
- 5 LCD Ekran Açma/Kapama Düğmesi
- 6 USB-C Girişi/Çıkışı Bağlantı Noktası
- 7 USB-C Çıkışı Bağlantı Noktası
- 8 USB-A Çıkışı Bağlantı Noktası
- 9 AC Çıkışı
- 10 AC Çıkışı Açma/Kapama Düğmesi
- 11 Güç Tasarruf Modu Açma/Kapama Anahtarı
- 12 Ortam Işığı
- 13 Ortam Işığı Açma/Kapama Düğmesi

- 2 Araç Soketi
- 4 LCD Ekran
- 6 USB-C Girişi/Çıkışı Bağlantı Noktası
- 8 USB-A Çıkışı Bağlantı Noktası
- 10 AC Çıkışı Açma/Kapama Düğmesi
- 12 Ortam Işığı
- 14 DC Girişi

Güç İstasyonunuzu Yeniden Şarj Etme

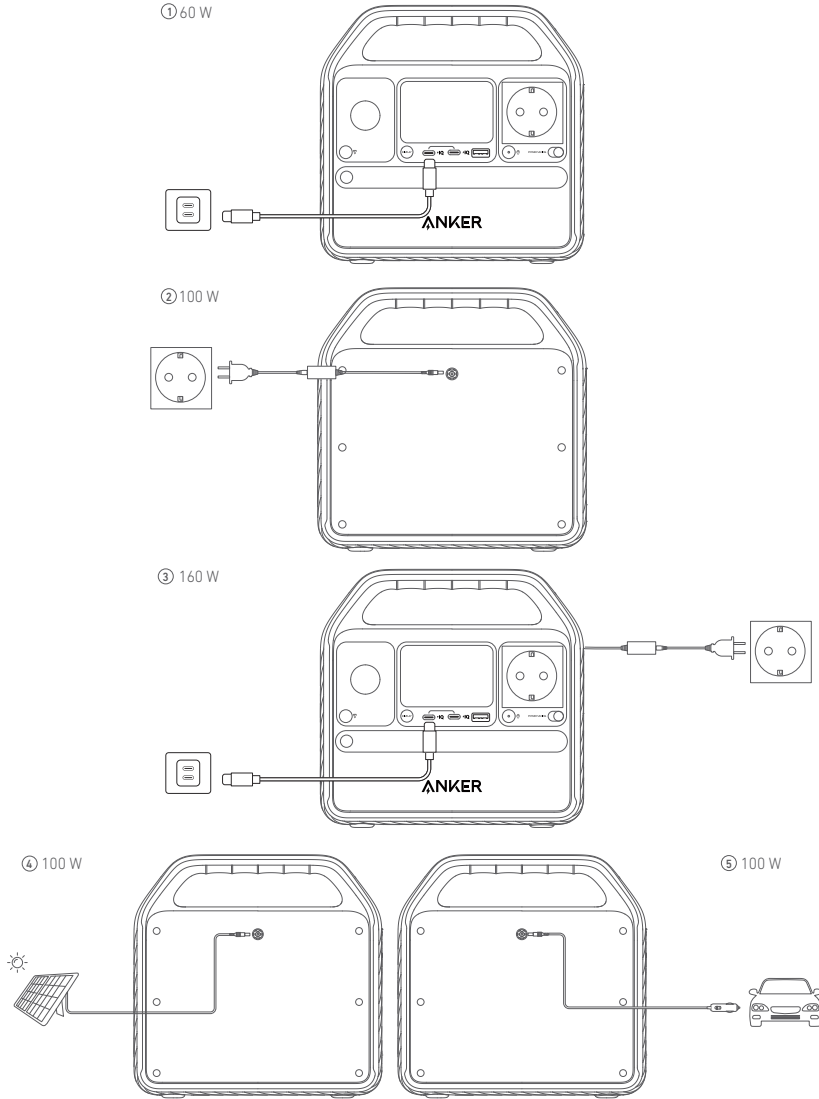

- Lütfen bu ürünü ilk kez kullanmadan önce tamamen şarj edin.
- Taşınabilir güç istasyonunuzun pil seviyesi %1'e düştüğünde, Kalan Pil göstergeleri size cihazı yeniden şarj etmenizi hatırlatmak için yanıp söner.

Cihazlarınıza Güç Sağlama

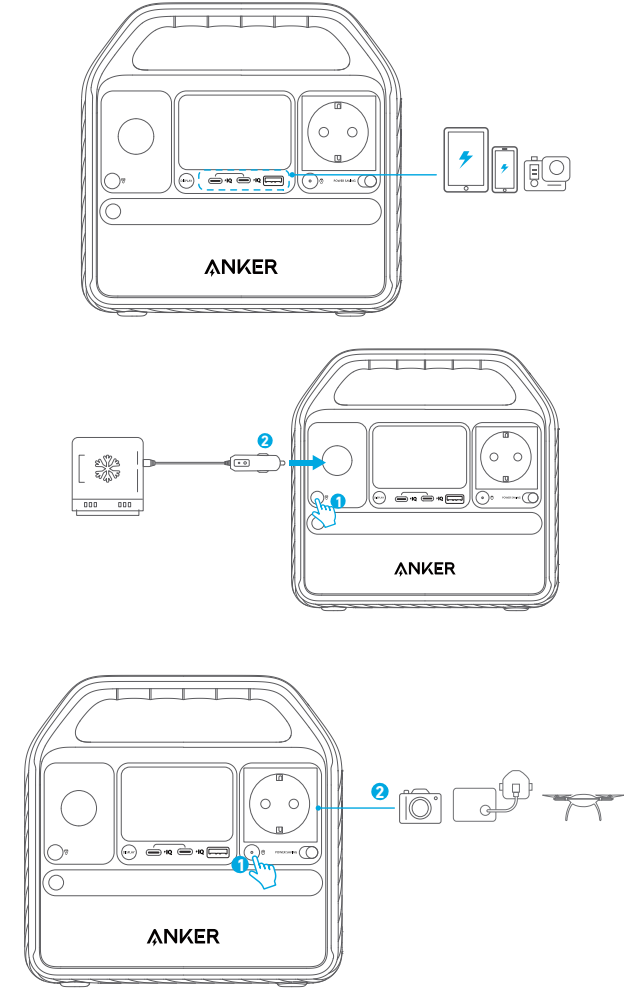

- 1.USB-A ve USB-C bağlantı noktaları, tak-kullan şarj işlevselliğini destekler. Cihazlar bağlantı noktasına takıldığında otomatik olarak şarj olmaya başlar; cihazlar çıkarıldığında otomatik olarak kapanır.
- 2.Araç soketi ve AC çıkışı, tak-kullan şarj işlevselliğini desteklemez. Şarj etmeden önce açmak için ilgili açma/kapama düğmelerini kullanın.
- 3.Pilin bitmesini önlemek için, CPAP makineleri ve kameralar gibi düşük güçlü cihazları şarj ettiğiniz durumlar dışında, Güç Tasarruf Modunu açık tutmanızı öneririz.

Güç Tasarrufu Modu

Güç tasarrufu modu açıldığında, tüm cihazlarınız tamamen şarj olduktan sonra Güç İstasyonu otomatik olarak kapatılarak gücün boşa harcanması önlenir.

Güç tasarrufu modu kapatıldığında, zaman atlamalı fotoğraf veya bir CPAP makinesiyle uyumak için kullanılan uzun süre boyunca sabit şarj özelliği sağlanır.

LCD Ekran Kılavuzu

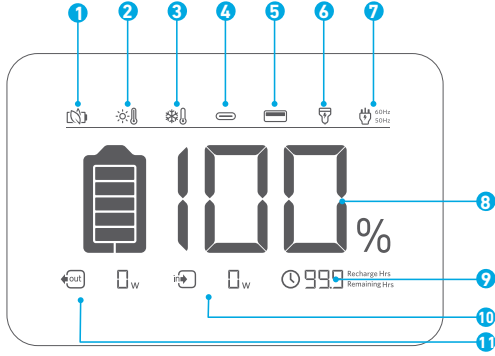

1 Güç Tasarrufu Modu

2 Yüksek Sıcaklık Uyarısı
• Bu simge görüldüğünde ürünü kullanmaya ara verin ve simge kaybolana kadar soğumaya bırakın.

3 Düşük Sıcaklık Uyarısı
• Bu simge görüldüğünde, simge kaybolana kadar ürünü kullanmaya ara verin.

4 USB-C Giriş/Çıkışı Bağlantı Noktası

5 USB-A Çıkışı

6 Araç Şarjı

7 60Hz
50Hz
AC Şarj ve Voltaj Frekansı

8 100%
Kalan Pil

9 999 Recharge Hrs
Remaining Hrs
Saat Olarak Kalan Pil

10 in W
Akım Giriş Gücü

11 out W
Akım Çıkış Gücü

El Feneri Modu

Ortam ışığını açmak için düğmeye bir kez basın.

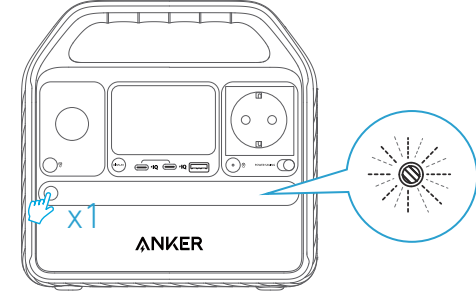

SOS modunu açmak için düğmeyi 2 saniye basılı tutun.

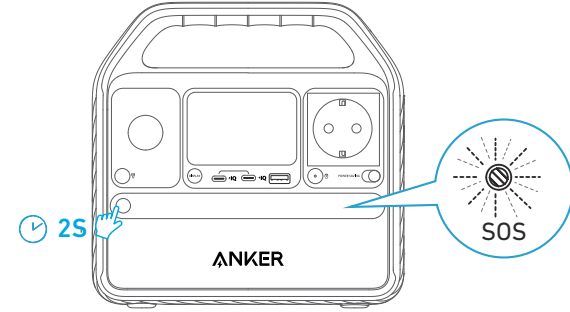

Sorun Giderme

Güç İstasyonunuzu Sıfırlama

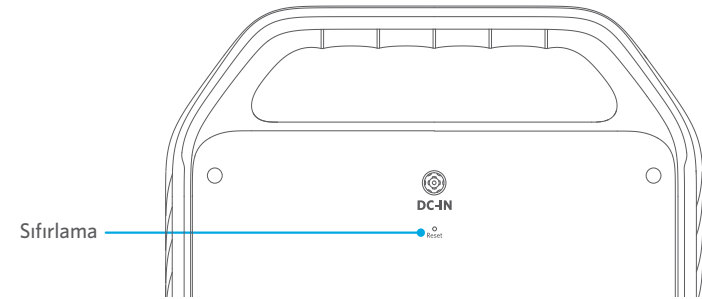

Güç İstasyonu düzgün çalışmıyorsa fabrika ayarlarına dönmek için sıfırlama deliğine 1 saniyelik bir ataş veya iğne sokun. Güç İstasyonu hâlâ çalışmıyorsa lütfen support@anker.com adresinden iletişime geçin.

S1: AC çıkışının maksimum çıkış gücü nedir?

300 W. AC bağlantı noktasını 300 Watt'dan daha yüksek güç çıkışı gerektiren cihazlar için kullanırsanız, ürün otomatik olarak kapanır.

S2: Bağlı cihazlar şarj edilirken ürünü şarj edebilir miyim?

Evet.

S3: Bu ürün bir CPAP cihazını besleyebilir mi?

Evet, ancak öncelikle Güç Tasarruf Modunu kapatmayı unutmayın.

S4: Kapatılmadığı takdirde, bu ürün otomatik olarak güç kaybeder mi?

Evet, hiçbir cihaz şarj ediliyor olmasa bile araç prizi veya AC kontrol düğmesi açıldığında belirli bir miktar yüksüz güç tüketimi görülür. Pilin bitmesini önlemek için CPAP makineleri ve kameralar gibi düşük güçlü cihazları şarj ettiğiniz durumlar dışında, Güç Tasarruf Modunu açık tutmanızı öneririz.

S5: Bu ürün ne tür bir solar şarj cihazı ile şarj edilebilir?

DC 8 mm (DC 7909) erkek konnektörlü herhangi bir 11 V - 28 V solar şarj cihazı kullanılabilir.

Teknik Özellikler

Hücre Kapasitesi	320 W/sa
DC Girişi	11 - 28 V \equiv 9 A (100 W Maks)
Araç Şarjı Çıkışı:	12 V \equiv 10 A
AC Çıkışı:	230V~,1,3A Maks, 50Hz, 300W Maks
USB-A Çıkışı/USB-A:	5 V \equiv 2,4 A (12 W Maks)
USB-C 1 Girişi:	5 V \equiv 3 A/9 V \equiv 3 A/15 V \equiv 3 A/20 V \equiv 3 A (60 W Maks)
USB-C 1 Çıkışı	5 V \equiv 3 A/9 V \equiv 3 A/15 V \equiv 3 A/20 V \equiv 3 A (60 W Maks)
USB-C 2 Çıkışı	5V \equiv 3A/ 9V \equiv 2,25A (20W Maks)
Boşalma Sıcaklığı	-20 °C - 40 °C (-4 °F - 104 °F)
Şarj Sıcaklığı	0 °C - 40 °C (32 °F - 104 °F)
Boyutlar	21,6 * 21,14 * 14,4 cm (8,5*8,32*5,67 inç)
Net Ağırlık	3,9 kg/8,6 lb

Dikkat

Uçakta kullanılması yasaktır.

ÖNEMLİ GÜVENLİK TALİMATLARI

UYARI: Bu ürünü kullanırken, aşağıdakiler de dahil olmak üzere temel önlemlere daima uyulmalıdır:

Ürünü kullanmadan önce tüm talimatları okuyun.

- Yaralanma riskini azaltmak için ürün çocukların yanında kullanılırken çok dikkat edilmelidir.
- Parmaklarınızı veya ellerinizi ürünün içine sokmayın.
- Ürünü yağmura veya kara maruz bırakmayın.
- Ürün üreticisi tarafından önerilmeyen veya satılmayan bir güç kaynağı veya şarj cihazının kullanılması, yangına veya yaralanmalara neden olabilir.
- Elektrik fişinin ve kablosunun hasar görme riskini azaltmak için ürünü çıkarırken kablodan değil fişten çekin.
- Ürünü nominal çıkış gücünün üzerinde kullanmayın. Çıkış gücünün üstündeki aşırı yükler, yangına veya yaralanmalara neden olabilir.
- Hasarlı veya üzerinde değişiklik yapılmış ürünü kullanmayın. Hasarlı veya üzerinde değişiklik yapılmış piller yangın, patlama veya yaralanmalara neden olabilecek öngörülemeyen davranışlar sergileyebilir.
- Ürünü hasarlı bir kabloyla veya fişle ya da hasar görmüş bir çıkış kablosuyla çalıştırmayın.
- Ürünü sökmeyin. Servis veya onarım gerektirdiğinde, ürünü kalifiye ve yetkili bir servise götürün. Hatalı montaj; yangın veya elektrik çarpması riski doğurabilir.
- Ürünü, açık alev tutmayın veya yüksek sıcaklığa maruz bırakmayın. Ürünün açık alev veya 265 °F'nin üzerindeki sıcaklıklara maruz bırakılması, patlamaya neden olabilir.
- Elektrik çarpması riskini azaltmak için talimatta açıklanan herhangi bir servis işlemine başlamadan önce güç paketini prizden çıkarın.
- Onarım işlemi, yalnızca orijinal yedek parça kullanan kalifiye bir teknisyen tarafından yapılmalıdır. Bu, ürün güvenliğinin sağlanması açısından gereklidir.
- Ürün, bir cihazı şarj ettiği sırada ısınabilir, çalışma sırasında bu normaldir ve endişe edilecek bir durum değildir.
- Dahili pil şarj edilirken iyi havalandırılmış bir alanda çalışmalı ve havalandırma hiçbir şekilde engellenmemelidir.
- Ürünü zararlı kimyasal maddelerle veya deterjanla temizlemeyin.
- Hatalı kullanım, düşürme veya aşırı güç uygulama üründe hasara neden olabilir.
- Yedek pilleri veya bataryaları atarken, farklı elektrokimyasal özelliklerdeki pilleri veya bataryaları birbirinden ayrı tutun.

Saklama ve Bakım talimatları

1. Ürünü 0°C-40°C (32°F-104°F) arasında saklayın. Ürünü yağmura maruz bırakmayın veya nemli ortamlarda kullanmayın.
2. Pil ömrünü korumak için kullandıktan sonra %100 seviyesine kadar şarj edin. Güç istasyonunuzu saklamayı planlıyorsanız her 3 ayda bir %100 seviyesine kadar şarj edin.
3. Ürünü kullanırken, şarj ederken ve saklarken düz bir yüzeyde tutun.

Uygunluk Beyanı

Anker Innovations Limited, işbu belge ile A1721 tipi ürünün 2014/35/EU, 2014/30/EU ve 2011/65/EU Yönergelerine uygun olduğunu beyan eder. AB uygunluk beyanının tam metni aşağıdaki İnternet adresinde mevcuttur:

<https://www.anker.com>



Bu sembol, bu ürünün evsel atık olarak işlem görmemesi gerektiğini belirtir. Bunun yerine, elektrikli ve elektronik ekipmanların geri dönüşümü için geçerli toplama noktasına teslim edilmelidir.

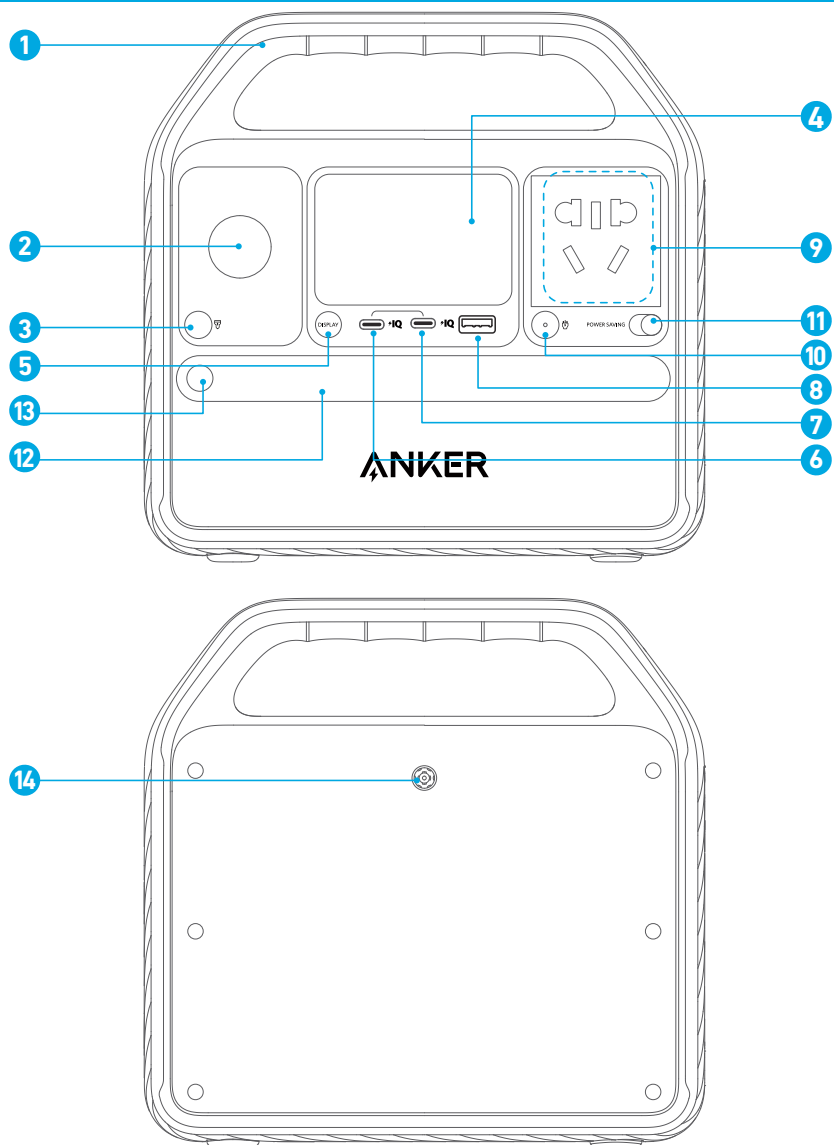

- 1 把手
- 2 点烟器
- 3 点烟器开 / 关按钮
- 4 液晶屏幕
- 5 液晶屏幕开 / 关按钮
- 6 USB-C 输入 / 输出端口
- 7 USB-C 输出端口
- 8 USB-A 输出端口
- 9 交流输出端口
- 10 交流输出端口开 / 关按钮
- 11 节能模式开关
- 12 环境光
- 13 环境光开 / 关按钮
- 14 直流输入端口

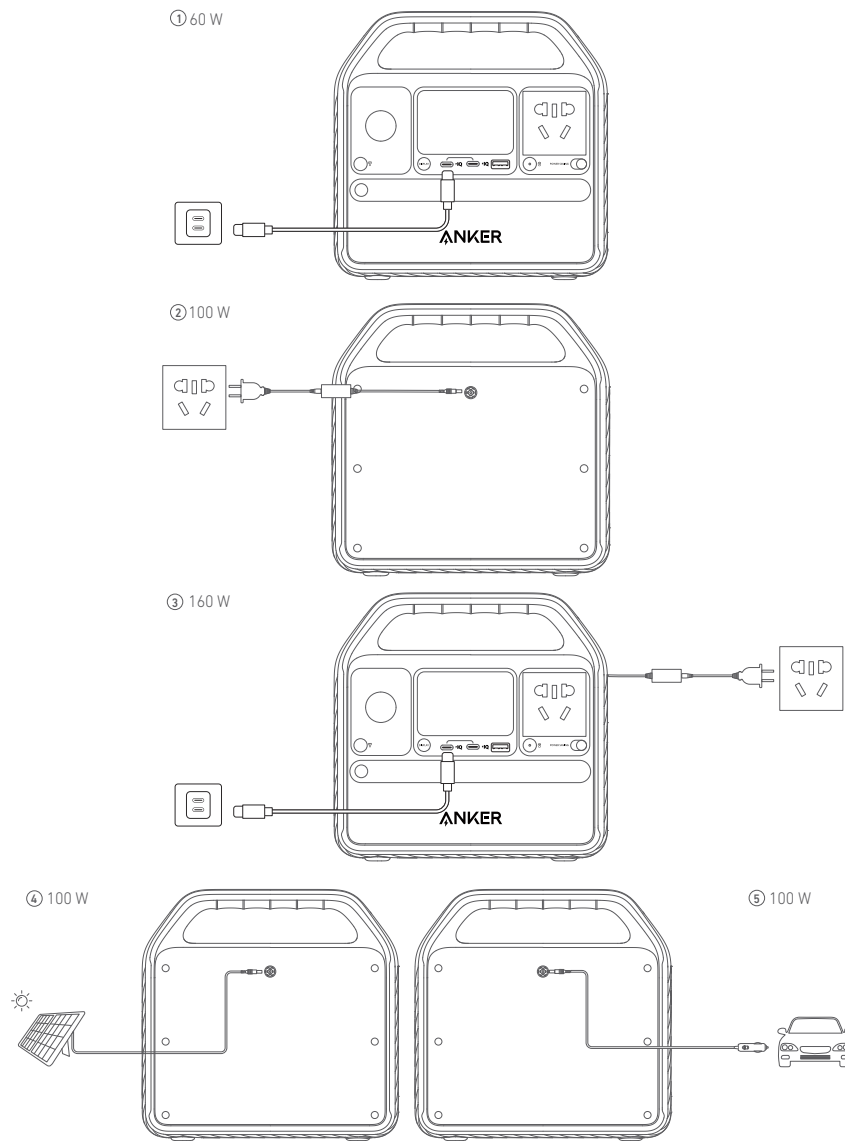

- 首次使用本产品前请先充满电。
- 当您的便携式发电站只剩 1% 电量时，剩余电量指示灯会闪烁，提醒您为设备充电。

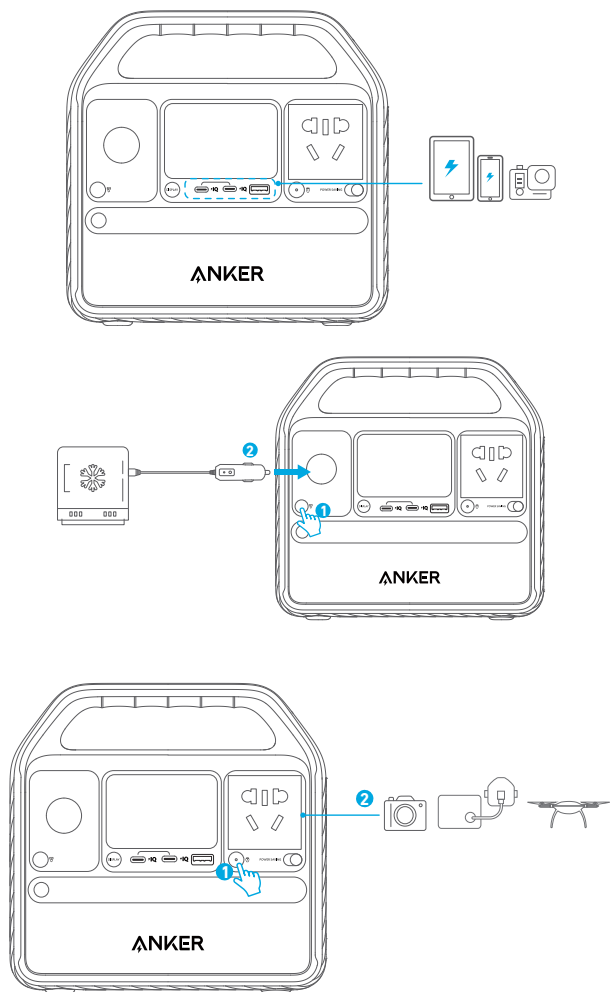

1. USB-A 和 USB-C 端口支持即插即充。设备插入后会自动开始充电；拔出后会自动关闭。
2. 点烟器和交流输出端口不支持即插即充，需要在充电前使用相应的开 / 关按钮将其打开。
3. 为避免电池电量耗尽，我们建议您除非是为 CPAP 机器和相机等低功率设备充电，否则最好一直开启节能模式。

节能模式

如果打开节能模式，则在所有设备充满电后，就会自动关闭发电站，从而防止浪费电能。关闭节能模式将能够在较长时间内实现稳定充电，例如用于延时摄影或在睡觉时使用 CPAP 机器。

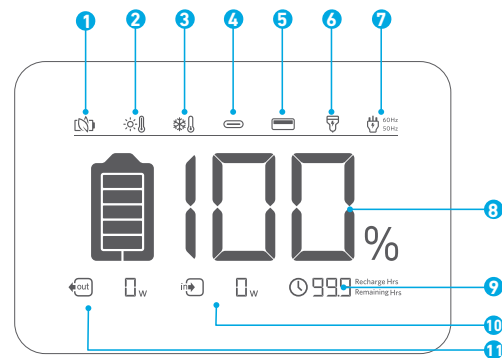

- 1 节能模式
- 2 高温警报
• 当此图标出现时，请停止使用产品，让产品冷却，直至图标消失。
- 3 低温警报
• 当此图标出现时，请停止使用产品，直至图标消失。
- 4 USB-C 输入 / 输出端口
- 5 USB-A 输出
- 6 车载充电
- 7 60Hz
50Hz 交流充电和电压频率
- 8 100% 剩余电池电量
- 9 999 Recharge Hrs Remaining Hrs 剩余电池电量 (小时)
- 10 当前输入功率
- 11 当前输出功率

手电筒模式

按一次按钮可打开环境光。

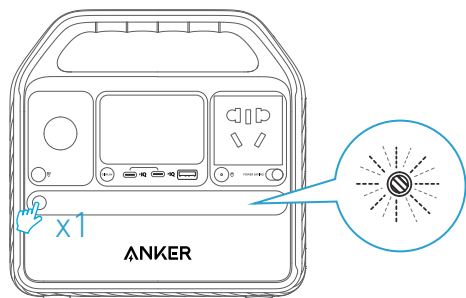

按住按钮 2 秒钟以打开 SOS 模式。

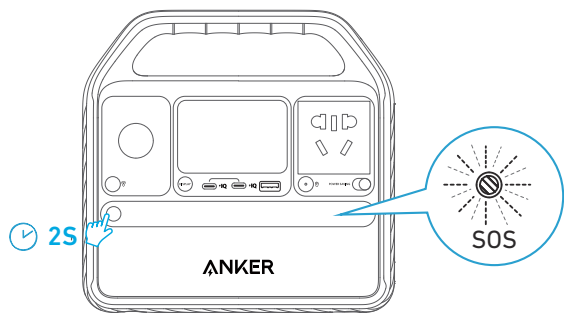

故障排除

重置您的产品

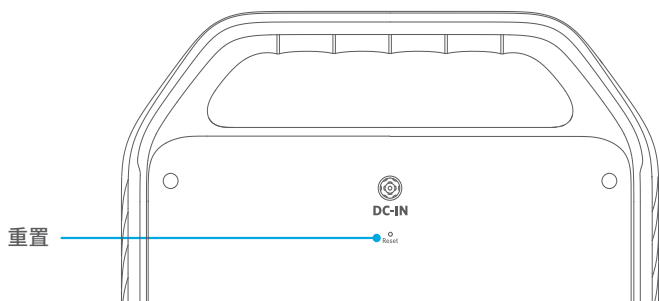

如果您的产品无法正常工作，请用回形针或大头针插入重置孔 1 秒钟来恢复出厂设置。如果发电站仍然无法工作，请联系 support@anker.com。

常见问题

问题 1: 交流端口的最大输出功率是多少？

300W。如果您在交流端口上使用的设备的功率大于 300W，产品会自动关闭。

问题 2: 我可以在为连接的设备充电的同时为产品充电吗？

可以。

问题 3: 该产品可以为 CPAP 供电吗？

可以，但不要忘记先关闭节能模式。

问题 4: 本产品不关机自动断电吗？

会。当点烟器或 AC 控制按钮打开时，即使没有设备充电，也会有一定的空载功耗。为避免电池电量耗尽，我们建议您除非是为 CPAP 机器和相机等低功率设备充电，否则最好一直开启节能模式。

问题 5: 哪种太阳能充电器可以给这个产品充电？

任何带有 DC 8mm (DC 7909) 插头的 11V-28V 太阳能充电器都可以。

规格

电池容量	320 Wh
直流输入	11-28V $\ddot{=}$ 9A (最大 100W)
车充输出	12V $\ddot{=}$ 10A
交流输出	220V~, 最大 1.36A, 50Hz, 最大 300W
USB-A 输出	5V $\ddot{=}$ 2.4A (最大 12W)
USB-C 1 输入	5V $\ddot{=}$ 3A/9V $\ddot{=}$ 3A/15V $\ddot{=}$ 3A/20V $\ddot{=}$ 3A (最大 60W)
USB-C 1 输出	5V $\ddot{=}$ 3A/9V $\ddot{=}$ 3A/15V $\ddot{=}$ 3A/20V $\ddot{=}$ 3A (最大 60W)
USB-C 2 输出	5V $\ddot{=}$ 3A/ 9V $\ddot{=}$ 2.25A (最大 20W)
放电温度	-4° F-104° F/-20° C-40° C
充电温度	32° F-104° F/0° C-40° C
尺寸	21.6*21.14*14.4 厘米 / 8.5*8.32*5.67 英寸
净重	3.9 公斤 / 8.6 磅

注意



不允许在飞机上使用。

重要安全说明

警告 - 使用本产品时，务必要采取基本的预防措施，包括：

使用产品前请阅读所有说明。

· 为降低受伤风险，在儿童附近使用本产品时需要密切监视。

· 请勿将手指或手伸入产品。

· 不要将产品暴露于雨、雪中。

· 使用非本产品制造商推荐或出售的电源或充电器会导致火灾或人员受伤风险。

为降低损坏电源插头和电源线的风险，断开产品时请拔插头，而不要拔电源线。

· 使用产品时不要超过输出额定值。超出额定值的过载输出可能会导致火灾或人员受伤风险。

· 请勿使用损坏或改动过的产品。损坏或改动后的电池可能会出现无法预料的情况，有可能导致火灾、爆炸或受伤风险。

请勿使用损坏的电源线或插头或损坏的输出电缆操作产品。

· 请勿拆卸产品。本产品如需服务或维修，请找合格的修理人员。重新组装不正确可能会导致火灾或触电风险。

· 不要暴露于火或高温环境下。暴露于火或温度超过 130°C 的环境时可能会引起爆炸。

为降低触电风险，在尝试任何指示的维修之前，请从插座中拔出电源组。

· 由合格的维修人员进行维修，只能使用相同的更换零件。这可以确保维修后产品仍然安全。

· 为设备充电时，产品可能会发热，这是正常现象，无需担心。

请在通风良好的地方给内置电池充电，不要以任何方式限制通风。

· 请勿使用有害化学品或清洁剂清洁本产品。

· 使用不当、摔落或过度用力可能会导致本产品损坏。

· 处置废旧旧电池时，请将不同电化学体系的电池分开。

存储和维护说明

1. 将本产品存放在 32° F 至 104° F (0°C -40°C) 的环境下。避免产品淋雨中或在潮湿的环境中使用产品。

2. 为延长电池使用寿命，请在使用后充满电。如果您打算存放便携电源，请每 3 个月充满电一次。

3. 使用、充电和存放时，请将产品放在平坦的表面上。

符合性声明

Anker Innovations Limited 特此声明，产品类型 A1721 符合欧盟指令 2014/35/EU、2014/30/EU 和 2011/65/EU 的要求。欧盟符合性声明的全文可在以下网址获取：

<https://www.anker.com>



此符号表明本产品不得作为生活垃圾处理。而是应将本产品送至相应的废品收集处，进行电子电气设备回收处理。

نظرة عامة

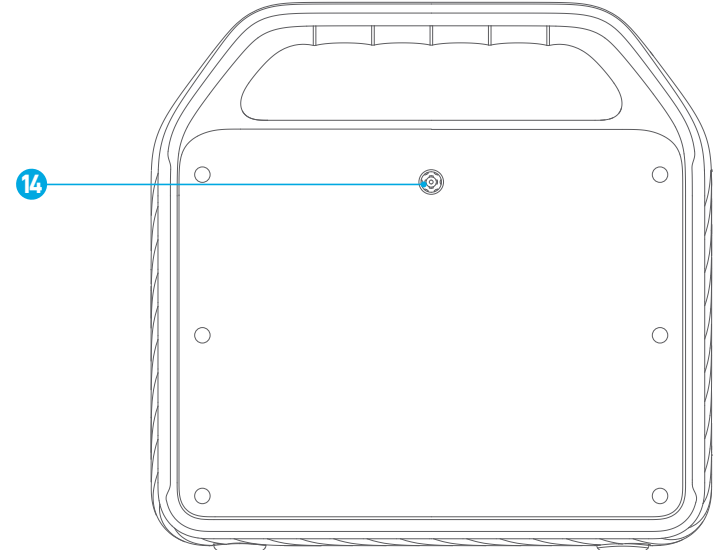
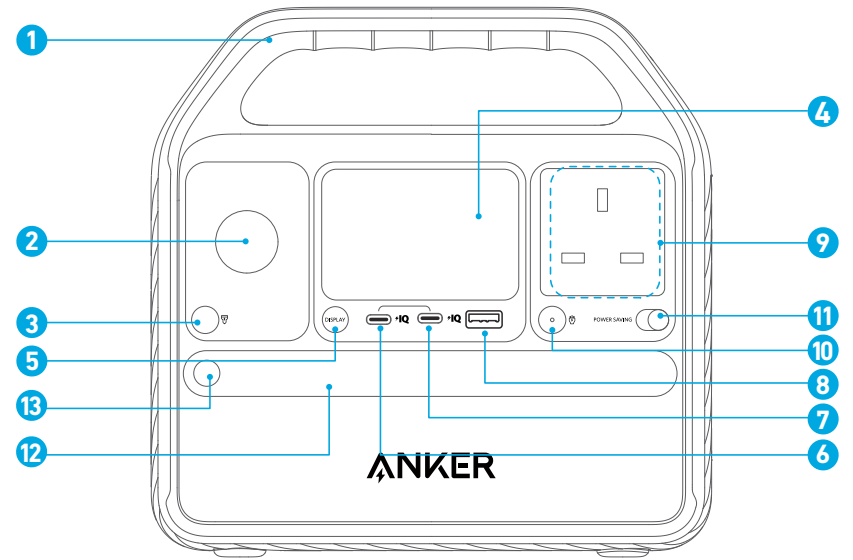

- | | | | |
|----|--|----|--|
| 1 | المقبض | 1 | زر تشغيل/إيقاف تشغيل مقبس السيارة |
| 2 | مقبس سيارة | 2 | زر تشغيل/إيقاف تشغيل شاشة LCD |
| 3 | زر تشغيل/إيقاف تشغيل مقبس السيارة | 3 | زر تشغيل/إيقاف تشغيل شاشة LCD |
| 4 | شاشة LCD | 4 | زر تشغيل/إيقاف تشغيل شاشة LCD |
| 5 | منفذ إدخال/مخرج USB-C | 5 | منفذ إخراج تيار متردد |
| 6 | منفذ إدخال/مخرج USB-C | 6 | مفتاح تشغيل/إيقاف تشغيل وضع توفير الطاقة |
| 7 | منفذ إخراج USB-A | 7 | منفذ إدخال تيار مستمر |
| 8 | منفذ إخراج USB-A | 8 | |
| 9 | منفذ إخراج تيار متردد | 9 | |
| 10 | زر تشغيل/إيقاف تشغيل منفذ إخراج تيار متردد | 10 | |
| 11 | مفتاح تشغيل/إيقاف تشغيل وضع توفير الطاقة | 11 | |
| 12 | الإضاءة المحيطة | 12 | |
| 13 | منفذ إدخال تيار مستمر | 13 | زر تشغيل/إيقاف تشغيل الإضاءة المحيطة |
| 14 | منفذ إدخال تيار مستمر | 14 | |

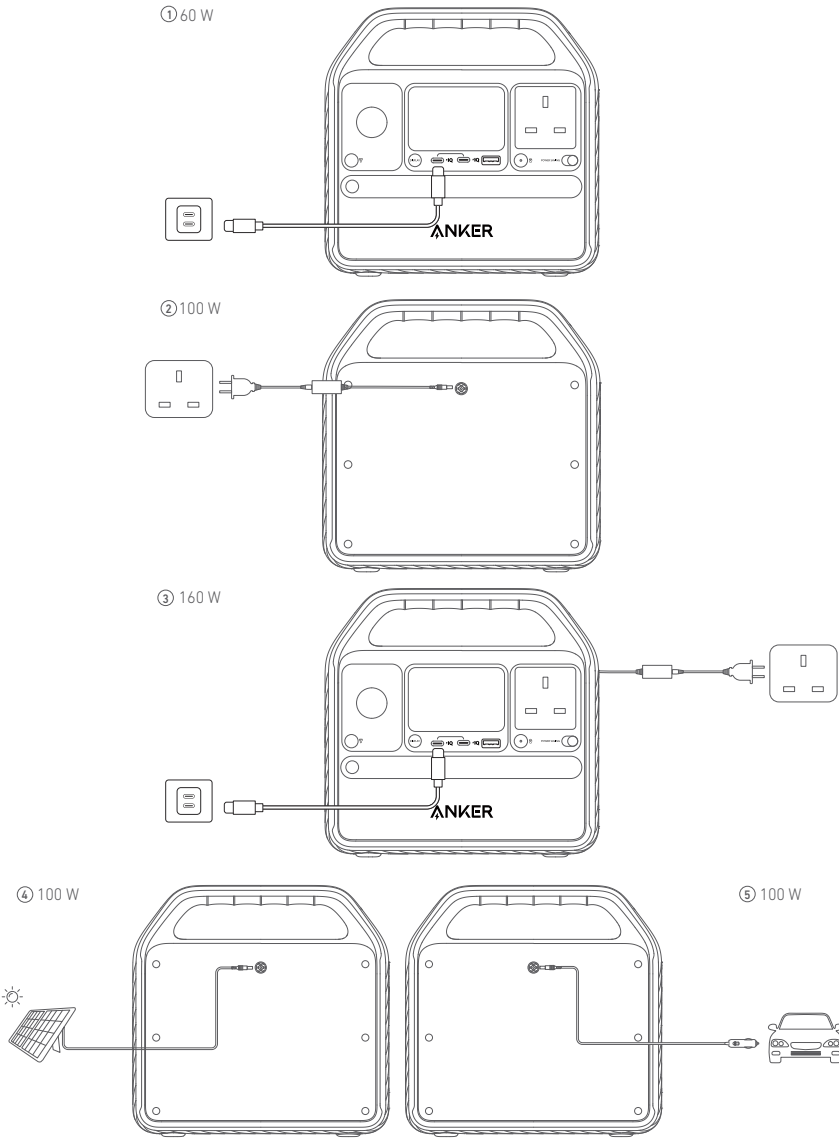

- يرجى شحن المنتج بالكامل قبل استخدامه لأول مرة.
- عندما تكون نسبة بطارية محطة الطاقة المحمولة المتبقية 1% فقط، سوف تومض مؤشرات البطارية المتبقية لتذكيرك بإعادة شحن الجهاز.

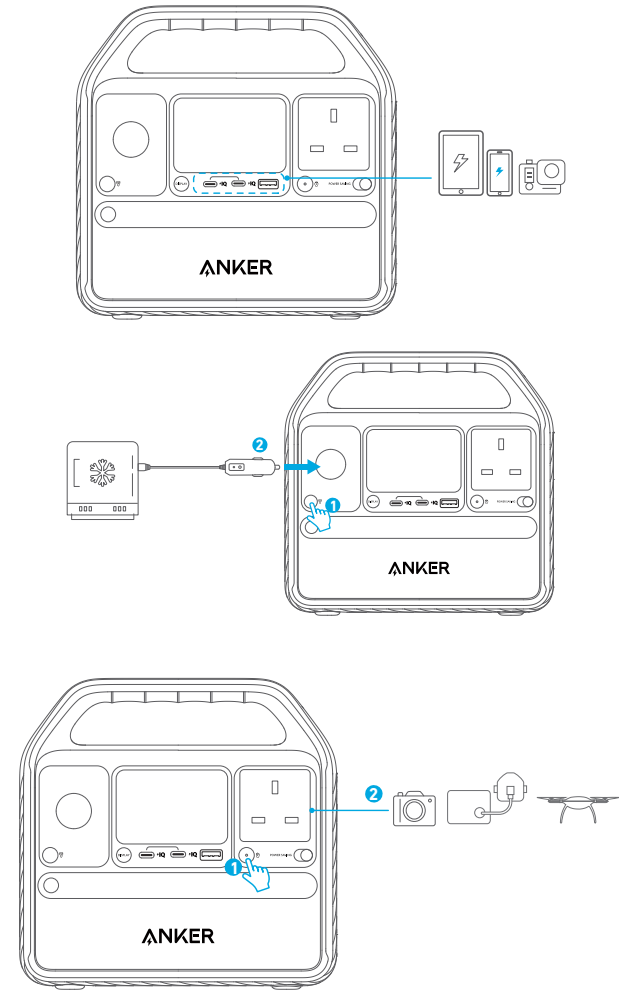

1. يدعم منفذ USB-A و USB-C التوصيل والشحن. عند توصيل الأجهزة، سوف تبدأ في الشحن تلقائيًا؛ وعند فصل الأجهزة، سوف يتم إيقاف تشغيلها تلقائيًا.
2. لا يدعم مقبس السيارة ومنفذ إخراج التيار المتردد التوصيل والشحن. استخدم أزرار التشغيل/الإيقاف المقلبة لتشغيلها قبل الشحن.
3. نوصي بالحفاظ على تشغيل وضع توفير الطاقة لتجنب استنزاف البطارية، إلا عندما تشحن أجهزة منخفضة الطاقة، مثل أجهزة CPAP والكاميرات.

وضع توفير الطاقة

يؤدي تشغيل وضع توفير الطاقة إلى منع إهدار الطاقة عن طريق إيقاف تشغيل Power Station تلقائيًا بمجرد شحن جميع أجهزتك بالكامل. سيؤدي إيقاف تشغيل وضع توفير الطاقة إلى تمكين الشحن المستمر على مدى فترة طويلة، مثل المعدل الزمني للتصوير أو للنوم باستخدام جهاز الضغط الإيجابي المستمر في المسالك الهوائية (CPAP).

دليل شاشة LCD

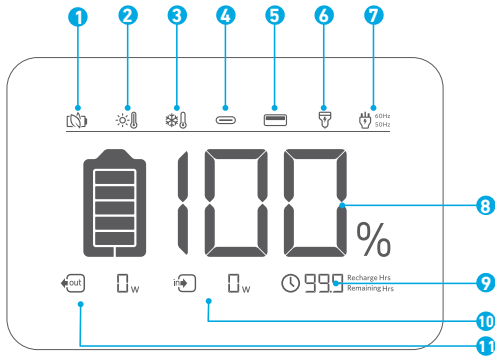

وضع توفير الطاقة



تنبيه ارتفاع درجة الحرارة

• عندما يظهر هذا الرمز، أوقف استخدام المنتج واتركه حتى يبرد حتى يختفي الرمز.



تنبيه انخفاض درجة الحرارة

• عندما يظهر هذا الرمز، أوقف استخدام المنتج حتى يختفي الرمز.



منفذ دخل/إخراج USB-C



إخراج USB-A



شحن سيارة



60Hz

50Hz

شحن AC والجهد التردد



لبطارية المتبقية



Recharge Hrs Remaining Hrs

لبطارية المتبقية في ساعات



طاقة إدخال التيار



طاقة إخراج التيار

وضع الكشف

اضغط على الزر مرة واحدة لتشغيل الإضاءة المحيطة.

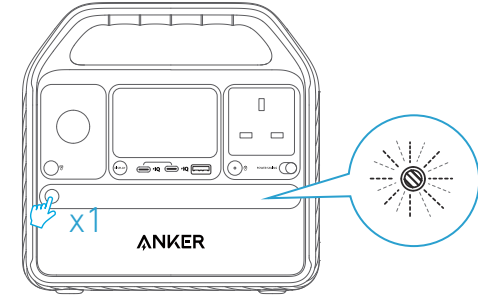

استمر في الضغط على الزر لمدة ثابنتين لتشغيل وضع SOS.

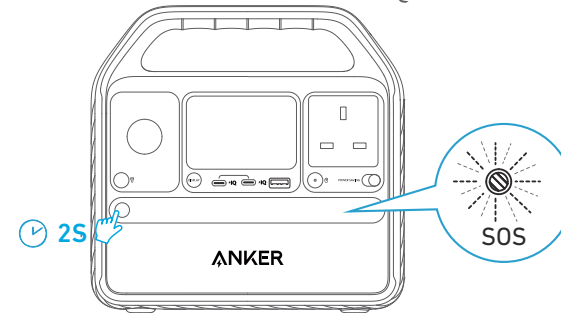

استكشاف أخطاء وإصلاحها

كيب قص اخل اقق اظلا قظحم ني عت قداع!

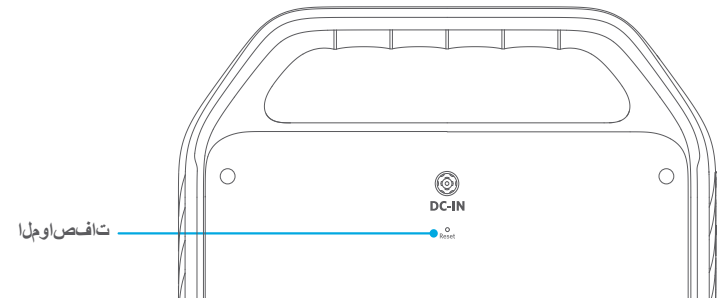

إذا كانت محطة الطاقة لديك لا تعمل بشكل صحيح، فقم بإدخال مشبك ورق أو دبوس في فتحة إعادة التعيين لمدة ثانية واحدة لاستعادة ضبط المصنع. إذا كانت محطة الطاقة لا تزال لا تعمل، فيرجى التواصل مع support@anker.com.

تعليمات السلامة المهمة

تحذير - عند استخدام هذا المنتج، يجب دائماً اتباع الاحتياطات الأساسية، بما في ذلك ما يلي:

اقرأ كل التعليمات قبل استعمال المنتج.

• يلزم الإشراف الدقيق عند استخدام المنتج بالقرب من الأطفال، لمنع خطر حدوث إصابات.

• لا تضع أصابع أو يديك داخل المنتج.

• لا تعرض المنتج للمطر أو الثلج.

• قد يؤدي استخدام مصدر طاقة أو شاحن غير موصى به أو غير مُباع من قبل الشركة المصنعة للمنتج إلى حدوث حريق أو إصابة الأشخاص.

• لفصل المنتج اسحب القابس بدلاً من السلك لمنع خطر تلف القابس والسلك الكهربائي.

• لا تستخدم المنتج بما يزيد عن معدل خرجه. فقد تؤدي المخارج الزائدة عن المعدل إلى مخاطر نشوب حريق أو حدوث إصابات للأشخاص.

• لا تستخدم المنتج التالف أو المعدل. قد تعمل البطاريات التالفة أو المعدلة بطريقة مختلفة غير متوقعة تتسبب في نشوب حريق أو حدوث انفجار أو تعرّض أشخاص لخطر الإصابة.

• تجنب تشغيل المنتج في حالة تلف السلك أو القابس أو كابل الخرج.

• لا تفكك المنتج. اصطحبه إلى فني صيانة مؤهل عند الحاجة إلى الصيانة أو الإصلاح. قد تؤدي إعادة التجميع غير الصحيح إلى خطر نشوب حريق أو التعرض لصدمة كهربائية.

• لا تعرضه للنار أو درجات الحرارة المرتفعة. قد يتسبب التعرض للنار أو درجة حرارة تفوق 130 درجة مئوية في حدوث انفجار.

• لمنع خطر التعرض لصدمة كهربائية، تأكد من فصل حزمة الطاقة من المخرج قبل إجراء أي خدمة صيانة.

• قم بإجراء الصيانة بواسطة فني إصلاح مؤهل وباستخدام قطع الغيار المتطابقة فقط. يضمن لك ذلك الحفاظ على سلامة المنتج.

• قد يسخن الجهاز عند الشحن، وهذه حالة تشغيل عادية ولا تدعو للقلق.

• يجب شحن البطارية الداخلية في بيئة جيدة التهوية وتجنب تقييد التهوية بأي شكل.

• لا تنظف المنتج بمواد كيميائية أو منظفات ضارة.

• قد يؤدي سوء الاستخدام أو السقوط أو القوة المفرطة إلى تلف المنتج.

• عند التخلص من الخلايا الثانوية أو البطاريات، احرص على فصل الخلايا أو البطاريات التي لها أنظمة كهروكيميائية مختلفة عن بعضها.

تعليمات التخزين والصيانة

1. فخزن المنتج بين 32 درجة فهرنهايت - 104 درجة فهرنهايت (0 درجة فهرنهايت - 40 درجة مئوية). تجنب تعريض المنتج للمطر أو استخدامه في بيئة رطبة.

2. للحفاظ على عمر البطارية، اشحنها حتى 100% بعد الاستخدام. إذا كنت تخطط لتخزين محطة الطاقة الخاصة بك، فتأكد من شحنها بنسبة 100% كل 3 أشهر.

3. احتفظ بالمنتج على سطح مستوي عند الاستخدام والشحن والتخزين.

إعلان المطابقة

تعلن شركة Anker Innovations Limited بموجب هذا المستند أن نوع المنتج A1721 متوافق مع التوجيهات EU/2014/35 و EU/2014/30 و EU/2011/65. النص الكامل لإعلان المطابقة في الاتحاد الأوروبي متاح على عنوان الإنترنت التالي: <https://www.anker.com>

يشير هذا الرمز إلى أنه لا يجب التعامل مع هذا المنتج على أنه نفايات منزلية. وبدلاً من ذلك، يجب تسليمه إلى نقطة التجميع المناسبة لإعادة تدوير المعدات الكهربائية والإلكترونية.



أسئلة الشائعة

س 1: ما الحد الأقصى لخرج الطاقة من منفذ التيار المتردد؟
300 واط، وإذا كنت تستخدم منفذ التيار المتردد لأجهزة أكبر من 300 واط فسيتم إيقاف تشغيل المنتج تلقائياً.

س 2: هل يمكنني إعادة شحن المنتج أثناء شحن الأجهزة المتصلة؟
نعم.

س 3: هل يمكن لهذا المنتج تشغيل أجهزة ضغط مجرى الهواء الإيجابي المستمر (CPAP)؟
نعم، لكن لا تنس إيقاف تشغيل وضع توفير الطاقة أو لا.

س 4: هل سيفقد هذا المنتج الطاقة تلقائياً إذا لم يتم إيقاف تشغيله؟
نعم، عند تشغيل مقبس السيارة أو زر التحكم في التيار المتردد، حتى إذا لم يتم شحن أي أجهزة، فسيظل هناك قدر معين من استهلاك الطاقة بدون حمل. نوصي بالحفاظ على تشغيل وضع توفير الطاقة لتجنب استنزاف البطارية، إلا عندما تشحن أجهزة منخفضة الطاقة، مثل أجهزة CPAP والكاميرات.

س 5: ما نوع الشاحن الشمسي الذي يمكنه شحن هذا المنتج؟

أي شاحن للطاقة الشمسية بقدرة 11 فولت إلى 28 فولت مع موصل ذكر DC 8 مم (DC 7909).

المواصفات

درة الخلية	320 واط
ال تيار المستمر	من 11 حتى 28 فولت --- 9 أمبير (100 واط بحد أقصى)
شحن السيارة	12 فولت --- 10 أمبير
إخراج التيار المتردد	230 فولت ~، 1.3 أمبير أقصى، 60 هرتز، ماكس 300 واط بحد أقصى
إخراج USB-A	5 فولت --- 2.4 أمبير (12 واط بحد أقصى)
إخراج USB-C 1	5 فولت --- 3 أمبير / 9 فولت --- 3 أمبير / 15 فولت --- 3 أمبير / 20 فولت --- 3 أمبير (60 واط بحد أقصى)
خرج USB-C 1	5 فولت --- 3 أمبير / 9 فولت --- 3 أمبير / 15 فولت --- 3 أمبير / 20 فولت --- 3 أمبير (60 واط بحد أقصى)
خرج USB-C 2	5 فولت --- 3 أمبير / 9 فولت --- 2.25 أمبير (20 واط بحد أقصى)
درجة حرارة التفريغ	من -4 درجة فهرنهايت حتى 104 درجات فهرنهايت / من -20 درجة مئوية حتى 40 درجة مئوية
درجة حرارة الشحن	من 32 درجة فهرنهايت حتى 104 درجات فهرنهايت / من 0 درجة مئوية حتى 40 درجة مئوية
الحجم	21.6 × 21.14 × 14.4 سم / 8.5 × 8.32 × 5.67 بوصة
لوزن الصافي	3.9 كجم / 8.6 أرطال

تنبيه



ير مسموح به على متن الطائرات.

Customer service

DE: Kundenservice

IT: Servizio Clienti

TR: Müşteri Hizmetleri

ES: Atención al Cliente

PT: Serviço de Apoio ao Client

简体中文: 客服支持

FR: Service Client

RU: Обслуживание клиентов

繁體中文: 客戶服務

خدمة العملاء: AR



support@anker.com

support.me@anker.com (For Middle East and Africa Only)



US/CA: +1 (800)988 7973

UK: +44(0)1604 936 200

DE: +49(0)69 9579 7960 +49 (800) 0002522(Anker SOLIX)

JP: +81 03 4455 7823

UAE: +971 8000 320 817

KSA: +966 8008 500 030

Kuwait: +965 2206 9086

Egypt: +20 8000 000 826

AU: +61 3 8331 4800

TR: +90(850)460 1414

RU: +8(800)511 8623

CN: +86 400 0550 036

KR: +82 02-1661-9246

IN: +91 1800 3138 831

Middle East & Africa: +971 520750842

