

Datenblatt

M12 Circular Connector, 5 contacts, Wire to Wire

Straight Pin Plug to Pin Socket

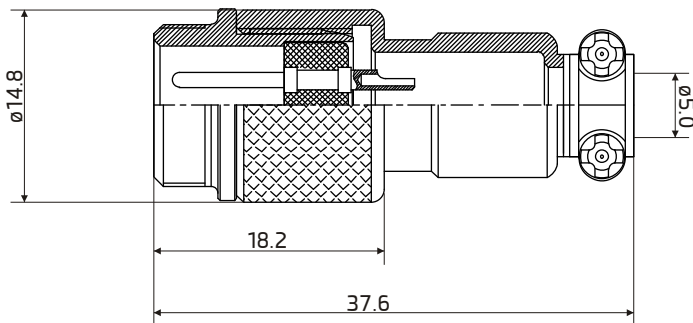
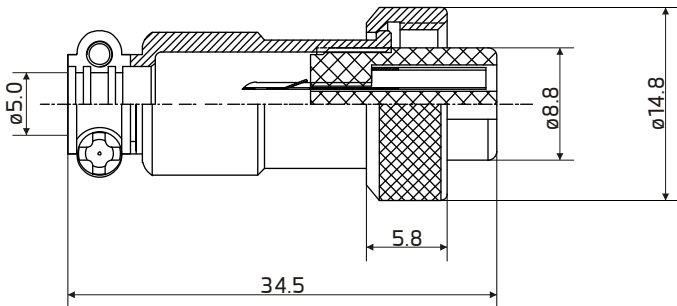

Dimension: mm \pm 0.2

Specification

Number of Contacts: 5
Mating thread type: M12

Material

Shell: Nickel plated Zinc Alloy
Insulation: Black Bakelite
Contact: Silver plated Copper

Electrical

Operating voltage: 60V
Rated current: 2 A
Insulation resistance: 100 M Ω min.
Contact resistance: 10 m Ω max.

Environment

Operation temperature: -20 to 85°C
Protect class: IP55
Termination: Solder
Suit Cable size: O.D. ϕ 5mm max.
Wire guide: AWG 22 - 20
Conductor cross-section: 0.34 - 0.5mm²