

EXTRUSION

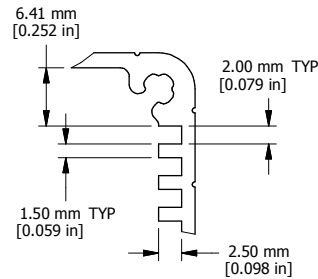

DETAIL A

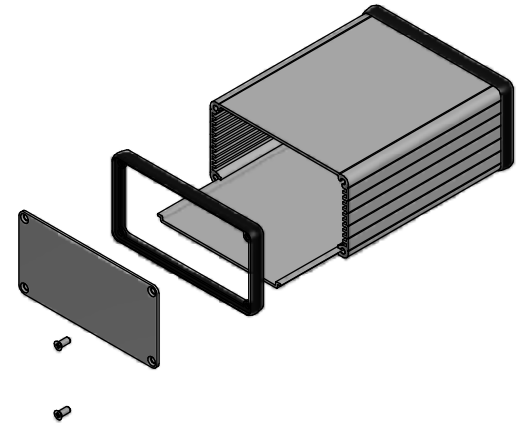

EXPLODED ASSEMBLY VIEW

EXTRUSION DESIGNED FOR 100MM WIDE PC BOARD

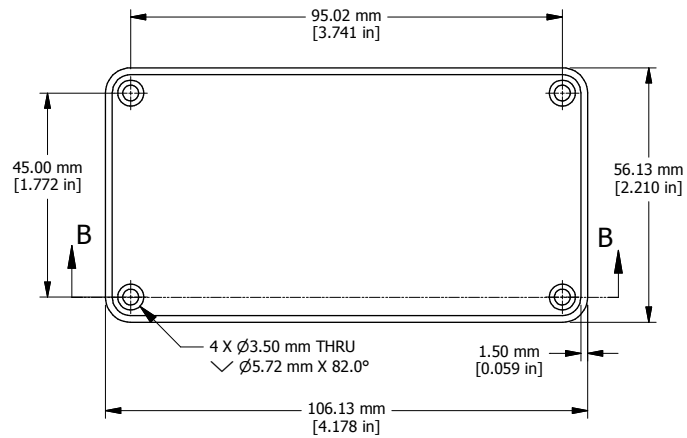
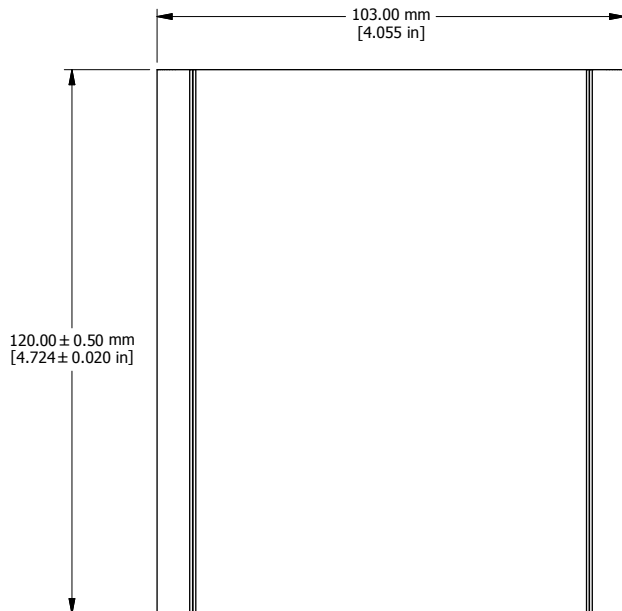

CLOSED BEZEL

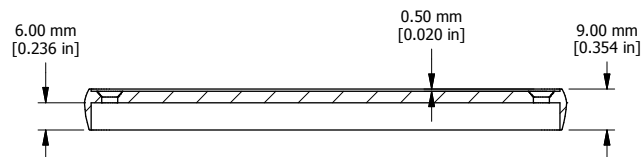

Enclosures can be Factory Modified ( Milling, Drilling, Printing etc. )  
Solid models of this enclosure available in STEP or IGES.  
Contact Factory [mjm@hammondmfg.com](mailto:mjm@hammondmfg.com)

**NOTE**

Purchased assembly includes box, plastic bezels, #6 Taptight screws and self adhesive rubber feet.

Box made from Extruded Aluminum 6063.

Bezels made with ABS.

**1455N1202**

**PART NUMBERS**

Clear Anodized	1455N1202
Black Anodized	1455N1202BK

**ACCESSORIES**

See website for accessories.

**HAMMOND  
MANUFACTURING™**

**1455N1202**

[www.hammondmfg.com](http://www.hammondmfg.com)