

## Features

- Output voltage tolerance  $\leq \pm 2\%$
- Low-drop voltage
- Integrated overtemperature protection
- Reverse polarity protection
- Input voltage up to 42 V
- Overvoltage protection up to 65 V ( $\leq 400$  ms)
- Short-circuit proof
- Suitable for use in automotive electronics
- Wide temperature range
- Adjustable reset and watchdog time

Type	Ordering Code	Package
▼ TLE 4271	Q67000-A9210-A901	P-TO220-7-11
▼ TLE 4271 S	Q67000-A9244-A901	P-TO220-7-12
▼ TLE 4271 G	Q67006-A9195-A901	P-TO263-7-1

▼ Not for new design, use TLE 4271-2 instead.

## Functional Description

It is a 5-V low-drop fixed-voltage regulator. The maximum input voltage is 42 V (65 V,  $\leq 400$  ms). Up to an input voltage of 26 V and for an output current up to 550 mA it regulates the output voltage within a 2 % accuracy. The short circuit protection limits the output current of more than 650 mA. The IC can be switched off via the inhibit input. An integrated watchdog monitors the connected controller. The device incorporates overvoltage protection and temperature protection that disables the circuit at unpermissibly high temperatures.

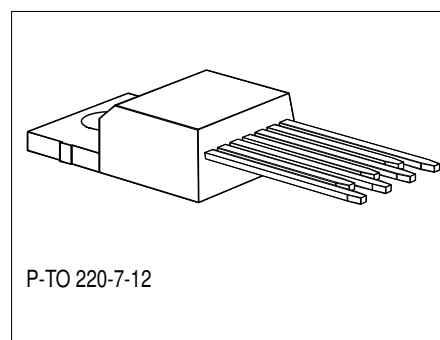
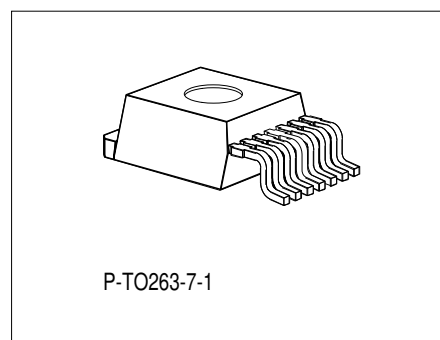
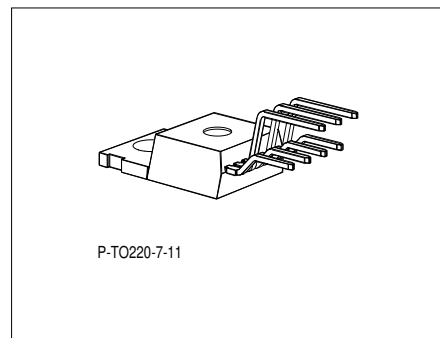

## Pin Configuration (top view)

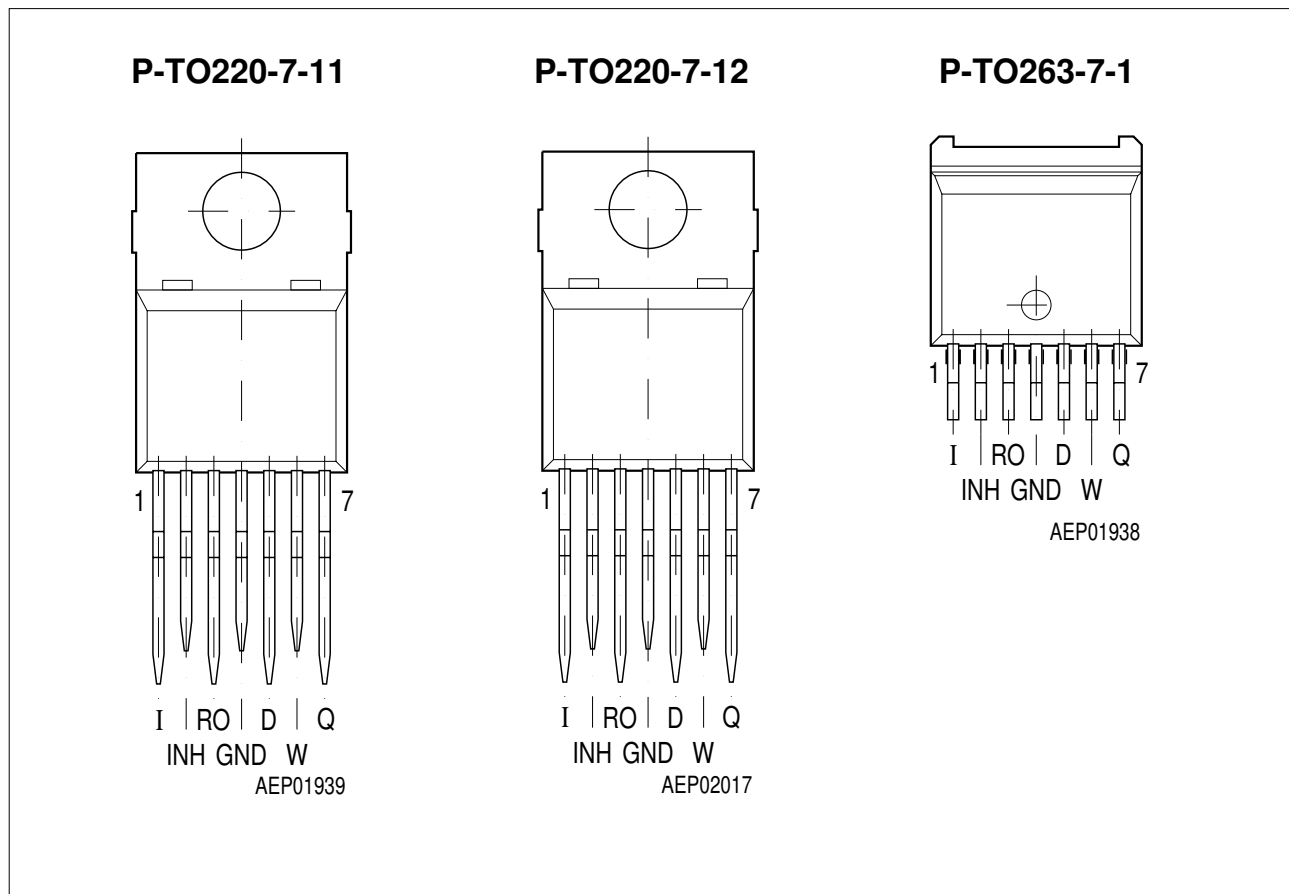

Figure 1

## Pin Definitions and Functions

Pin	Symbol	Function
1	I	<b>Input</b> ; block to ground directly on the IC with ceramic capacitor.
2	INH	<b>Inhibit</b>
3	RO	<b>Reset Output</b> ; the open collector output is connected to the 5 V output via an integrated resistor of 30 kΩ.
4	GND	<b>Ground</b>
5	D	<b>Reset Delay</b> ; connect a capacitor to ground for delay time adjustment.
6	W	<b>Watchdog Input</b>
7	Q	<b>5-V Output</b> ; block to ground with 22 μF capacitor, ESR < 3 Ω.

## Circuit Description

The control amplifier compares a reference voltage, which is kept highly accurate by resistance adjustment, to a voltage that is proportional to the output voltage and drives the base of a series transistor via a buffer. Saturation control as a function of the load current prevents any over-saturation of the power element.

If the output voltage decreases below 4.5 V, an external capacitor  $C_D$  on pin 4 (D) will be discharged by the reset generator. If the voltage on this capacitor  $V_D$  drops below  $V_{DRL}$ , a reset signal is generated on pin 2 (RO), i.e. reset output is set low. If the output voltage rises above 4.5 V,  $C_D$  will be charged with constant current. After the power-on-reset time  $V_D$  reaches  $V_{DU}$  and the reset output will be set high again. The value of the power-on-reset time can be set within a wide range depending on the capacity of  $C_D$ . The value of the pull-up resistor at reset output is typically 30 k $\Omega$ .

After  $V_D$  has reached the voltage  $V_{DU}$  and reset was set to high, the watchdog circuit is enabled and discharges  $C_D$  with a constant current. If there is no positive-going edge observed at watchdog input,  $C_D$  will be discharged down to  $V_{DWL}$ . Then reset will be set low and the watchdog circuit will be disabled.  $C_D$  will be charged with the current as at power-on reset until  $V_D$  reaches  $V_{DU}$  and reset will be set high again.

If a watchdog pulse will be observed before  $C_D$  is discharged down to  $V_{DWL}$ , the watchdog circuit will be enabled and  $C_D$  will be charged too, but reset will not be set low. After  $V_D$  has reached  $V_{DU}$ , the periodical behavior starts again.

The IC also incorporates a number of internal circuits for protection against:

- Overload
- Overvoltage
- Overtemperature
- Reverse polarity

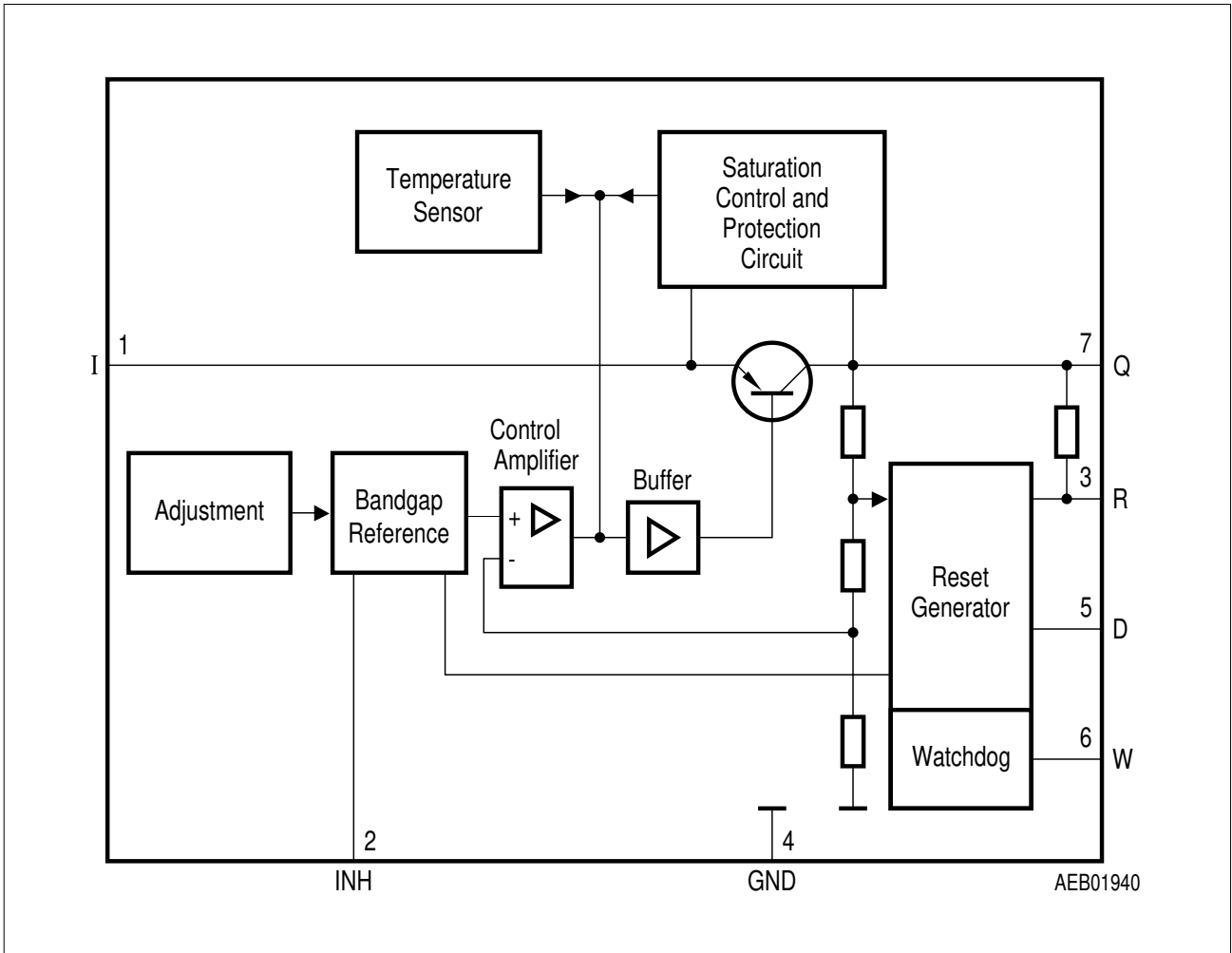

**Figure 2**  
**Block Diagram**

**Absolute Maximum Ratings**
 $T_j = -40$  to  $150$  °C

Parameter	Symbol	Limit Values		Unit	Notes
		min.	max.		

**Input**

Voltage	$V_I$	-42	42	V	-
Voltage	$V_I$	-	65	V	$t \leq 400$ ms
Current	$I_I$	-	-	mA	internally limited

**Inhibit**

Voltage	$V_E$	-42	42	V	-
Voltage	$V_E$	-	65	V	$t \leq 400$ ms
Current	$I_E$	-	-	mA	internally limited

**Reset Output**

Voltage	$V_R$	-0.3	42	V	-
Current	$I_R$	-	-	mA	internally limited

**Reset Delay**

Voltage	$V_D$	-0.3	7	V	-
Current	$I_D$	-5	5	mA	-

**Watchdog**

Voltage	$V_W$	-0.3	7	V	-
Current	$I_W$	-5	5	mA	-

**Output**

Voltage	$V_Q$	-1.0	16	V	-
Current	$I_Q$	-5	-	mA	internally limited

**Ground**

Current	$I_{GND}$	-0.5	-	A	-
---------	-----------	------	---	---	---

**Temperatures**

Junction temperature	$T_j$	-	150	°C	-
Storage temperature	$T_{stg}$	-50	150	°C	-

**Operating Range**

Parameter	Symbol	Limit Values		Unit	Notes
		min.	max.		
Input voltage	$V_I$	6	40	V	–
Junction temperature	$T_j$	– 40	150	°C	–

**Thermal Resistance**

Junction ambient	$R_{thja}$	–	65	K/W	–
			70	K/W	P-TO263
Junction case	$R_{thjc}$	–	3	K/W	–
	$Z_{thjc}$	–	2	K/W	$t < 1$ ms

**Characteristics**
 $V_I = 13.5 \text{ V}; -40 \text{ }^\circ\text{C} \leq T_j = \leq 125 \text{ }^\circ\text{C}$  (unless otherwise specified)

Parameter	Symbol	Limit Values			Unit	Test Condition
		min.	typ.	max.		
Output voltage	$V_Q$	4.90	5.00	5.10	V	$5 \text{ mA} \leq I_Q \leq 550 \text{ mA};$ $6 \text{ V} \leq V_I \leq 26 \text{ V}$
Output voltage	$V_Q$	4.90	5.00	5.10	V	$26 \text{ V} \leq V_I \leq 36 \text{ V};$ $I_Q \leq 300 \text{ mA};$
Output current limiting	$I_{Qmax}$	650	800	–	mA	$V_Q = 0 \text{ V}$
Current consumption $I_q = I_I$	$I_q$	–	–	50	$\mu\text{A}$	$V_e = 0 \text{ V}; I_Q = 0 \text{ mA}$
Current consumption $I_q = I_I$	$I_q$	–	800	–	$\mu\text{A}$	$V_e = 5 \text{ V}; I_Q = 0 \text{ mA}$
Current consumption $I_q = I_I - I_Q$	$I_q$	–	1	1.5	mA	$I_Q = 5 \text{ mA}$
Current consumption $I_q = I_I - I_Q$	$I_q$	–	55	75	mA	$I_Q = 550 \text{ mA}$
Current consumption $I_q = I_I - I_Q$	$I_q$	–	70	90	mA	$I_Q = 550 \text{ mA}; V_I = 5 \text{ V}$
Drop voltage	$V_{dr}$	–	350	700	mV	$I_Q = 550 \text{ mA}^{1)}$
Load regulation	$\Delta V_Q$	–	25	50	mV	$I_Q = 5 \text{ to } 550 \text{ mA};$ $V_I = 6 \text{ V}$
Supply voltage regulation	$\Delta V_Q$	–	12	25	mV	$V_I = 6 \text{ to } 26 \text{ V}$ $I_Q = 5 \text{ mA}$
Power supply Ripple rejection	$PSRR$	–	54	–	dB	$f_r = 100 \text{ Hz};$ $V_r = 0.5 V_{PP}$

<sup>1)</sup> Drop voltage =  $V_I - V_Q$  (measured when the output voltage has dropped 100 mV from the nominal value obtained at 13.5 V input)

**Characteristics (cont'd)**
 $V_I = 13.5 \text{ V}; -40 \text{ }^\circ\text{C} \leq T_j = \leq 125 \text{ }^\circ\text{C}$  (unless otherwise specified)

Parameter	Symbol	Limit Values			Unit	Test Condition
		min.	typ.	max.		

**Reset Generator**

Switching threshold	$V_{RT}$	4.5	4.65	4.8	V	–
Reset high voltage	$V_{ROH}$	4.5	–	–	V	–
Reset low voltage	$V_{ROL}$	–	60	–	mV	$R_{intern} = 30 \text{ k}\Omega^{(2)}$ ; $1.0 \text{ V} \leq V_Q \leq 4.5 \text{ V}$
Reset low voltage	$V_{ROL}$	–	200	400	mV	$I_R = 3 \text{ mA}, V_Q = 4.4 \text{ V}$
Reset pull-up	$R$	18	30	46	K $\Omega$	internally connection to Q3
Lower reset timing threshold	$V_{DRL}$	0.2	0.45	0.8	V	$V_Q < V_{RT}$
Charge current	$I_d$	8	14	25	$\mu\text{A}$	$V_D = 1.0 \text{ V}$
Upper timing threshold	$V_{DU}$	1.4	1.8	2.3	V	–
Delay time	$t_d$	8	13	18	ms	$C_D = 100 \text{ nF}$
Reset reaction time	$t_{RR}$	–	–	3	$\mu\text{s}$	$C_D = 100 \text{ nF}$

**Overvoltage Protection**

Turn-Off voltage	$V_{I,ov}$	40	44	46	V	–
------------------	------------	----	----	----	---	---

**Inhibit**

Inhibit ON voltage	$V_{INH}$	1.0	2.0	3.5	V	$V_Q = \text{high} (> 4.5 \text{ V})$
Inhibit OFF voltage	$V_{INH}$	0.8	1.3	3.3	V	$V_Q = \text{low} (< 0.8 \text{ V})$
Inhibit current	$I_{INH}$	8	12	25	$\mu\text{A}$	$V_{INH} = 5 \text{ V}$

**Watchdog**

Upper timing threshold	$V_{DU}$	1.4	1.8	2.3	V	–
Lower watchdog timing threshold	$V_{DWL}$	0.2	0.45	0.8	V	–
Discharge current	$I_{dis}$	1.5	2.7	3.5	$\mu\text{A}$	$V_D = 1 \text{ V}$



**Characteristics** (cont'd)

 $V_I = 13.5 \text{ V}; -40 \text{ }^\circ\text{C} \leq T_j = \leq 125 \text{ }^\circ\text{C}$  (unless otherwise specified)

Parameter	Symbol	Limit Values			Unit	Test Condition
		min.	typ.	max.		
Charge current	$I_d$	8	14	25	$\mu\text{A}$	$V_D = 1 \text{ V}$
Watchdog period	$t_w$	40	55	75	ms	$C_D = 100 \text{ nF}$
Watchdog trigger time	$t_{wt}$	30	45	66	ms	$C_D = 100 \text{ nF}$ see diagram
Watchdog pulse slew rate	$V_w$	5	–	–	$\text{V}/\mu\text{s}$	from 20% to 80% $V_Q$

<sup>2)</sup> Reset peak is always lower than 1.0 V.

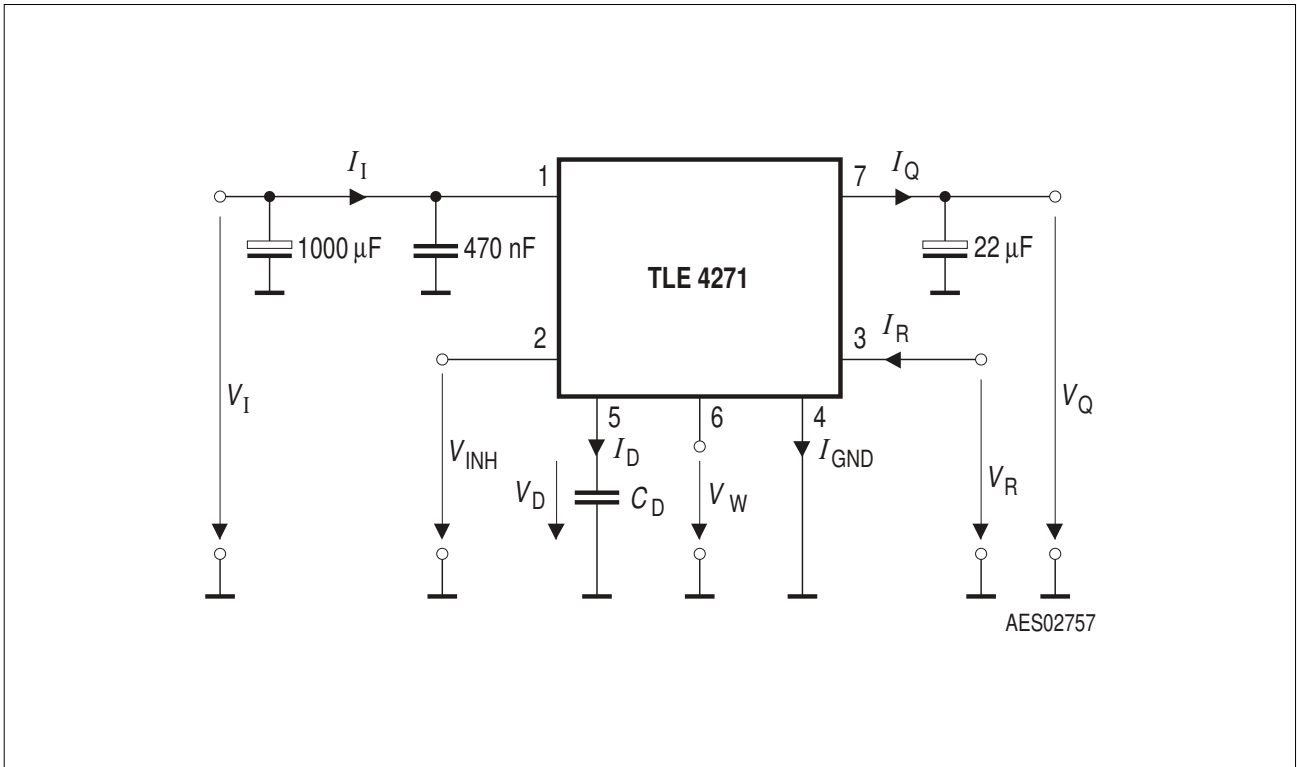

**Figure 3**  
**Test Circuit**

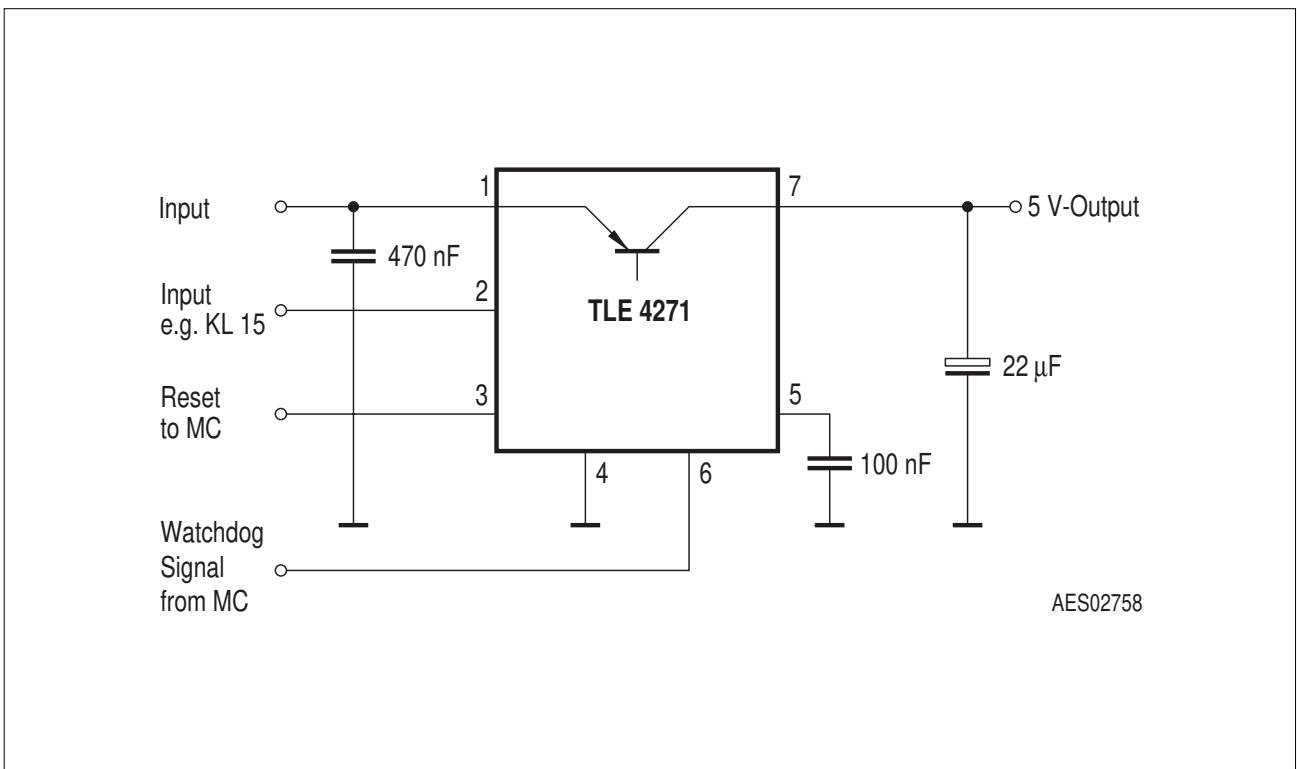

**Figure 4**  
**Application Circuit**

## Application Description

The IC regulates an input voltage in the range of  $5.5\text{ V} < V_I < 36\text{ V}$  to  $V_{Qnom} = 5.0\text{ V}$ . Up to  $26\text{ V}$  it produces a regulated output current of more than  $550\text{ mA}$ . Above  $26\text{ V}$  the save-operating-area protection allows operation up to  $36\text{ V}$  with a regulated output current of more than  $300\text{ mA}$ . Overvoltage protection limits operation at  $42\text{ V}$ . The overvoltage protection hysteresis restores operation if the input voltage has dropped below  $36\text{ V}$ . The IC can be switched off via the inhibit input, which causes the quiescent current to drop below  $50\text{ }\mu\text{A}$ . A reset signal is generated for an output voltage of  $V_Q < 4.5\text{ V}$ . The watchdog circuit monitors a connected controller. If there is no positive-going edge at the watchdog input within a fixed time, the reset output is set to low. The delay for power-on reset and the maximum permitted watchdog-pulse period can be set externally with a capacitor.

## Design Notes for External Components

An input capacitor  $C_I$  is necessary for compensation of line influences. The resonant circuit consisting of lead inductance and input capacitance can be damped by a resistor of approx.  $1\text{ }\Omega$  in series with  $C_I$ . An output capacitor  $C_O$  is necessary for the stability of the regulating circuit. Stability is guaranteed at values of  $C_O \geq 22\text{ }\mu\text{F}$  and an ESR of  $< 3\text{ }\Omega$ .

## Reset Circuitry

If the output voltage decreases below  $4.5\text{ V}$ , an external capacitor  $C_D$  on pin D will be discharged by the reset generator. If the voltage on this capacitor drops below  $V_{DRL}$ , a reset signal is generated on pin RO, i.e. reset output is set low. If the output voltage rises above the reset threshold,  $C_D$  will be charged with constant current. After the power-on-reset time the voltage on the capacitor reaches  $V_{DU}$  and the reset output will be set high again. The value of the power-on-reset time can be set within a wide range depending of the capacitance of  $C_D$ .

## Reset Timing

The power-on reset delay time is defined by the charging time of an external capacitor  $C_d$  which can be calculated as follows:

$$C_d = (t_d \times I_d) / \Delta V$$

Definitions:

- $C_d$  = delay capacitor
- $t_d$  = reset delay time
- $I_d$  = charge current, typical  $5\text{ mA}$
- $\Delta V = V_{DU}$ , typical  $1.9\text{ V}$
- $V_{DU}$  = upper delay switching threshold at  $C_d$  for reset delay time
- $t_d = \Delta V \times C_D / I_D$

The reset reaction time  $t_{rr}$  is the time it takes the voltage regulator to set the reset out LOW after the output voltage has dropped below the reset threshold. It is typically 1  $\mu$ s for delay capacitor of 47 nF. For other values for  $C_d$  the reaction time can be estimated using the following equation:

$$t_{rr} \approx 20 \text{ s/F} \times C_d$$

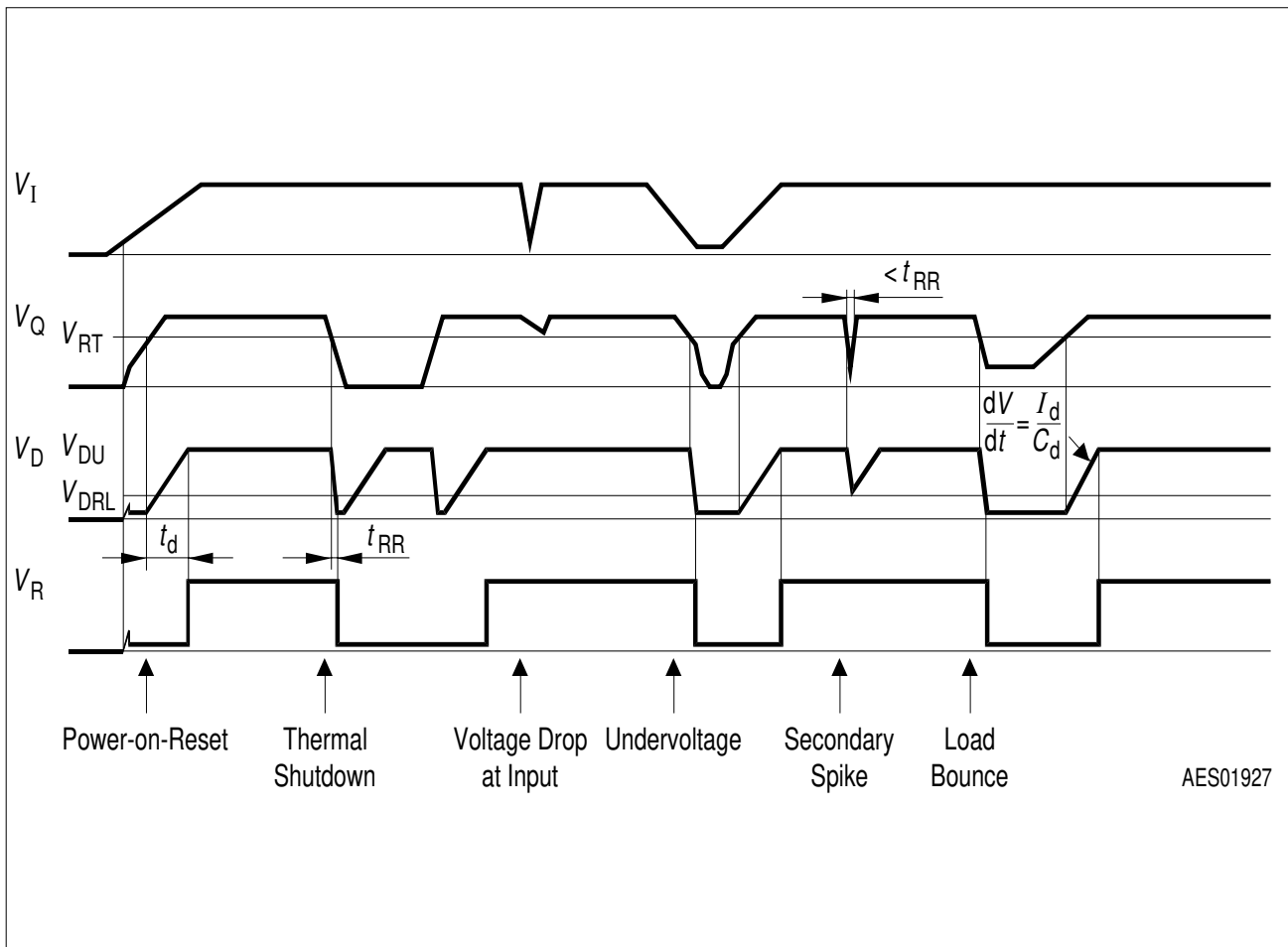

**Figure 5**  
**Time Response**

### Watchdog Timing

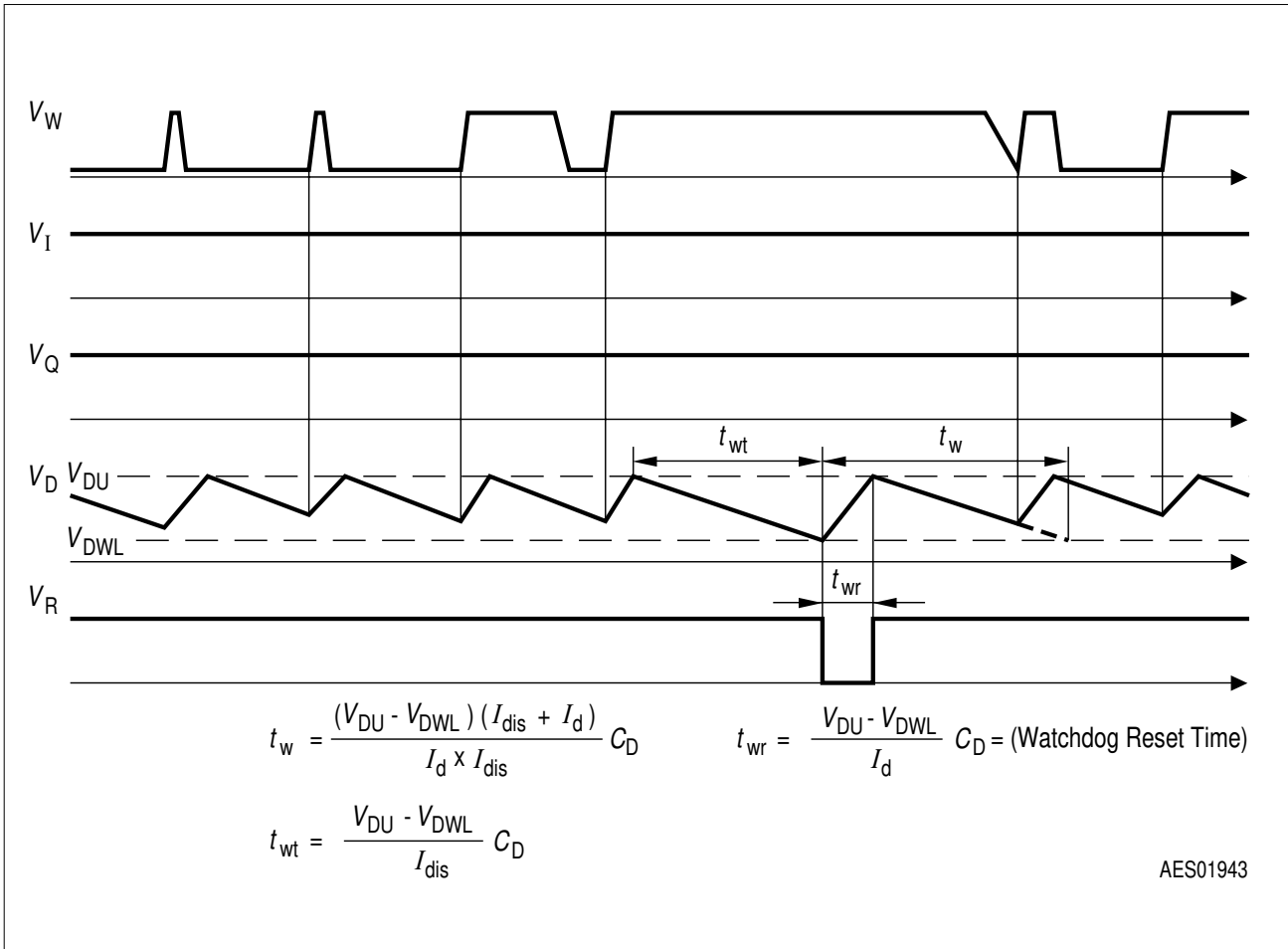

**Figure 6**  
**Time Response, Watchdog Behavior**

### Typical Performance Characteristics

**Output Voltage  $V_Q$  versus Temperature  $T_j$**

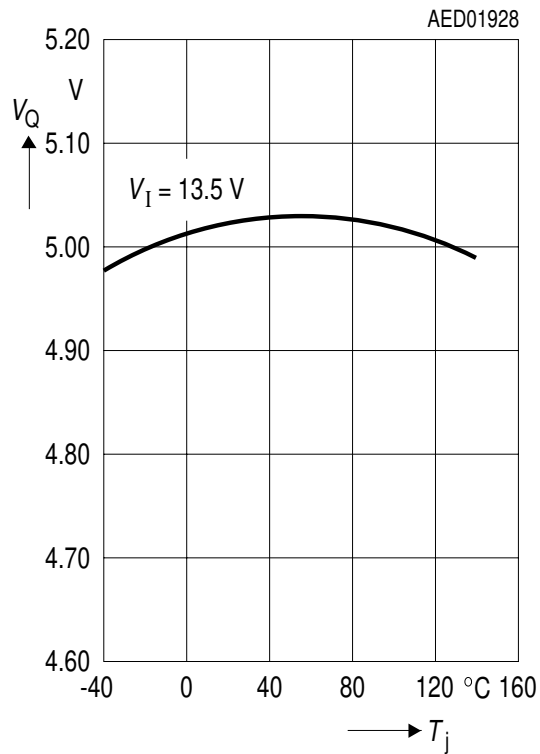

**Output Voltage  $V_Q$  versus Input Voltage  $V_I$  ( $V_I = V_e$ )**

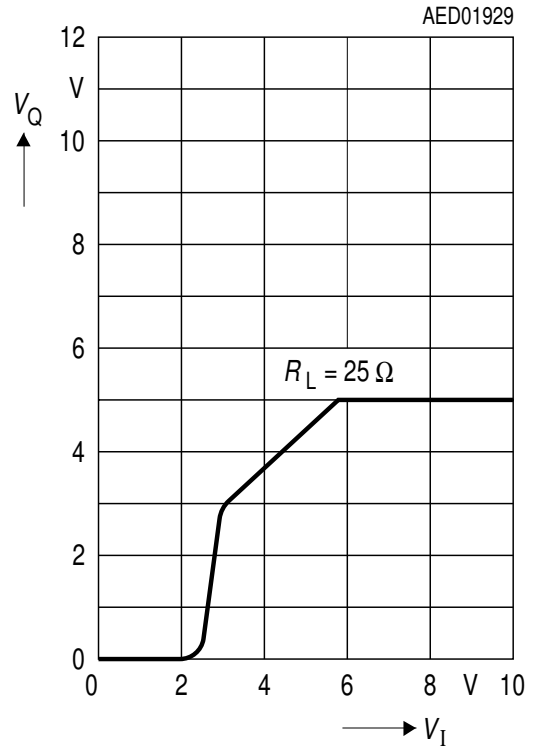

**Output Current  $I_Q$  versus Temperature  $T_j$**

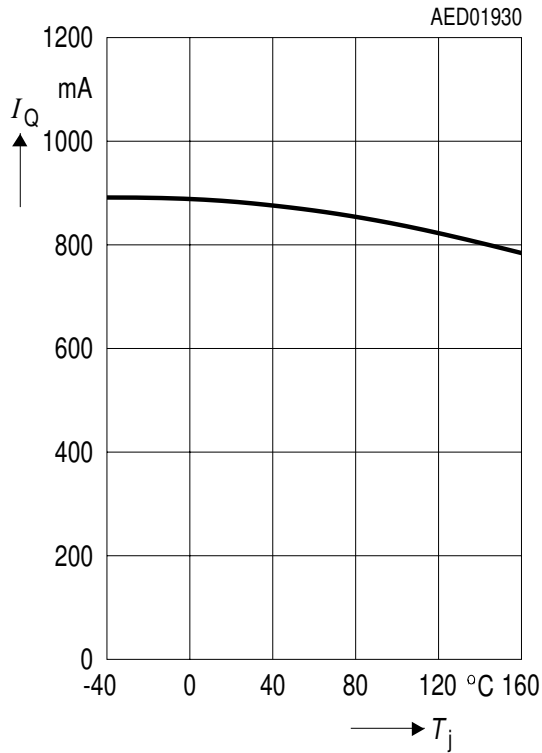

**Output Current  $I_Q$  versus Input Voltage  $V_I$**

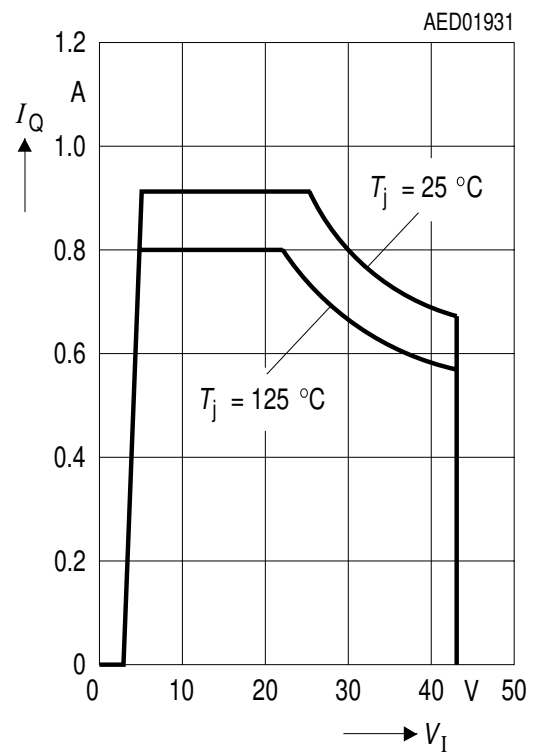

**Current Consumption  $I_q$  versus Output Current  $I_Q$**

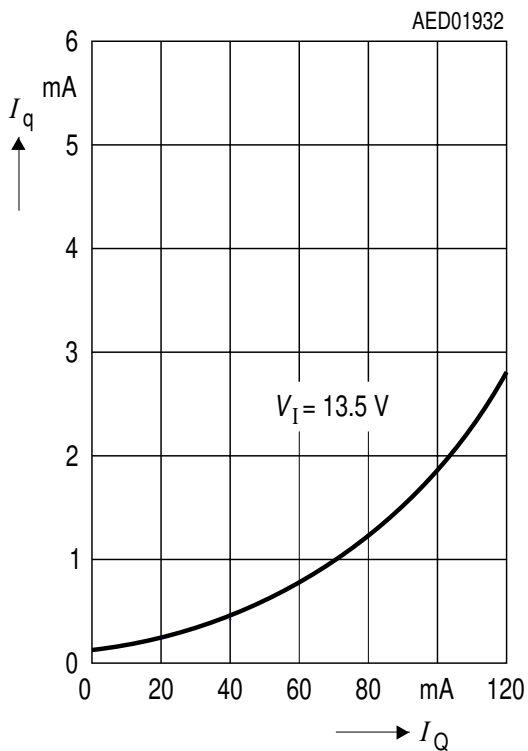

**Current Consumption  $I_q$  versus Output Current  $I_Q$**

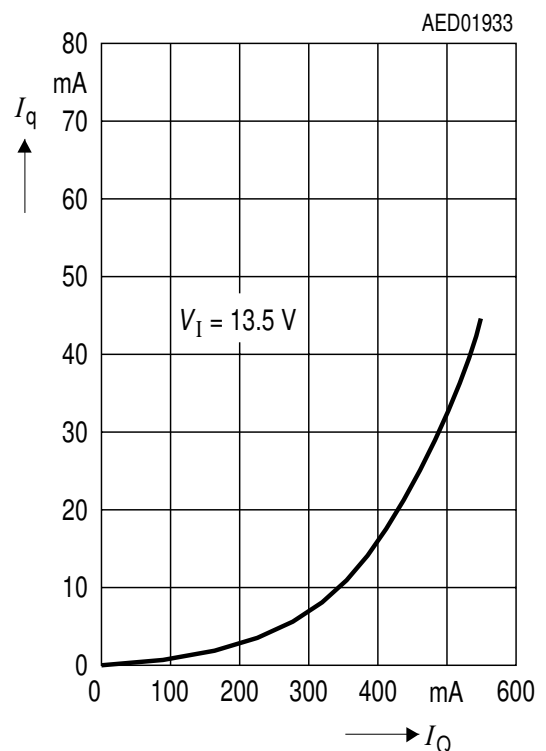

**Current Consumption  $I_q$  versus Input Voltage  $V_I$**

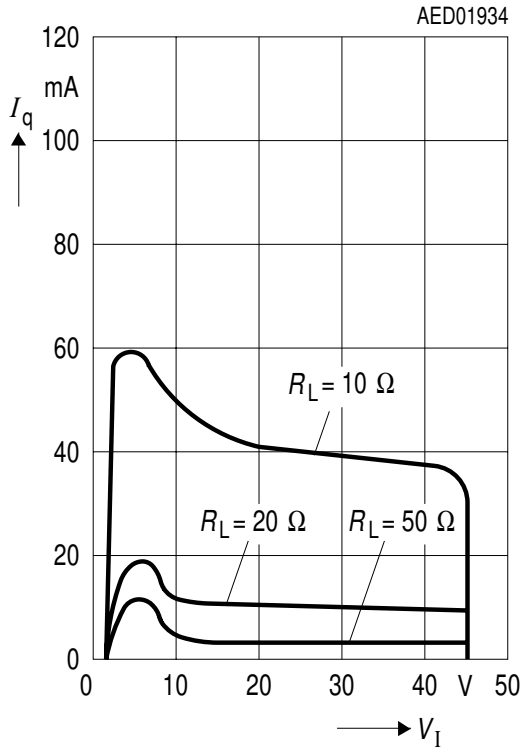

**Drop Voltage  $V_{Dr}$  versus Output Current  $I_Q$**

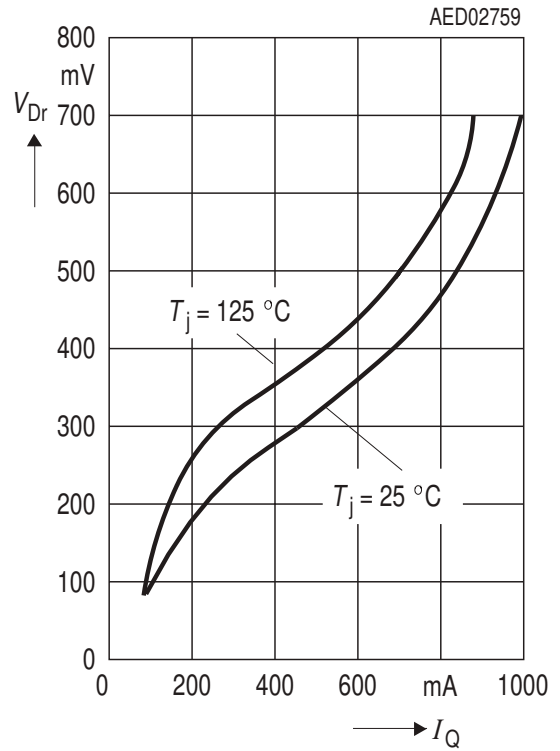

**Inhibit Current  $I_E$  versus Inhibit Voltage  $V_E$**

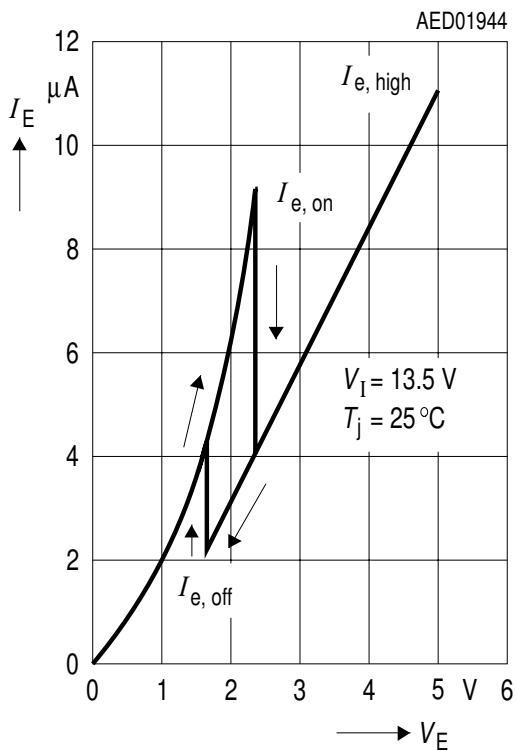

**Output Voltage  $V_Q$  versus Inhibit Voltage  $V_E$**

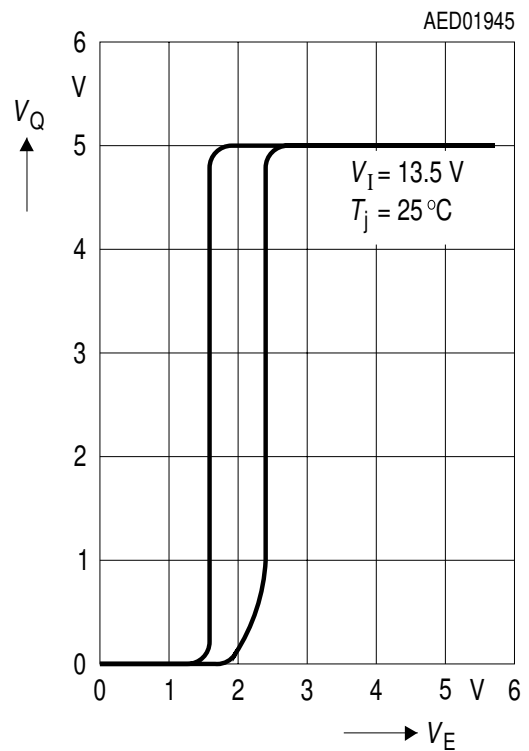



**Inhibit Current Consumptions  $I_e$  versus Temperature  $T_j$**

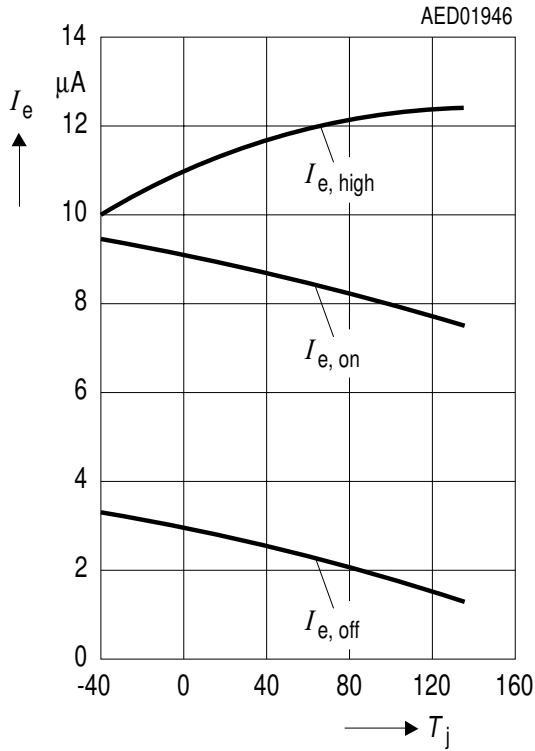

**Inhibit Voltages  $V_e$  versus Temperature  $T_j$**

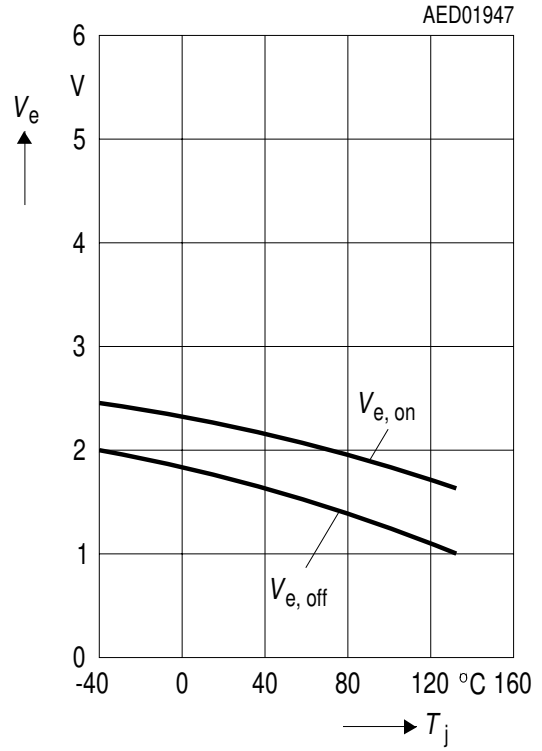

**Switching Voltage  $V_{DU}$  and  $V_{DWL}$  versus Temperature  $T_j$**

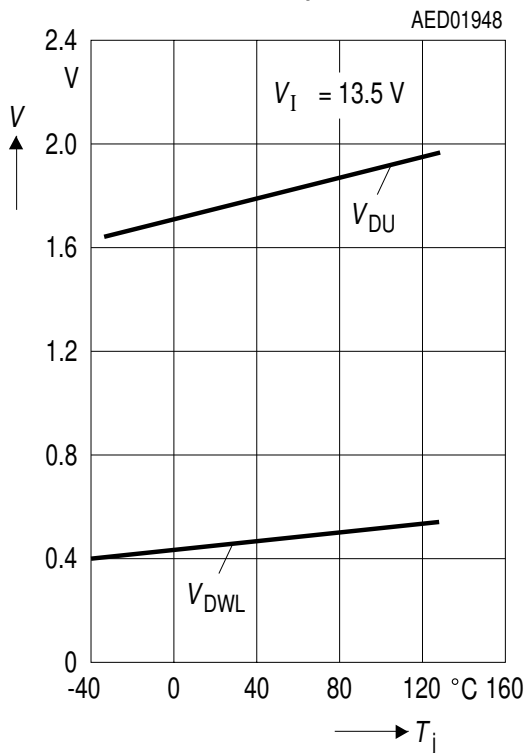

**Charge Current  $I_d$  and Discharge Current  $I_{dis}$  versus Temperature  $T_j$**

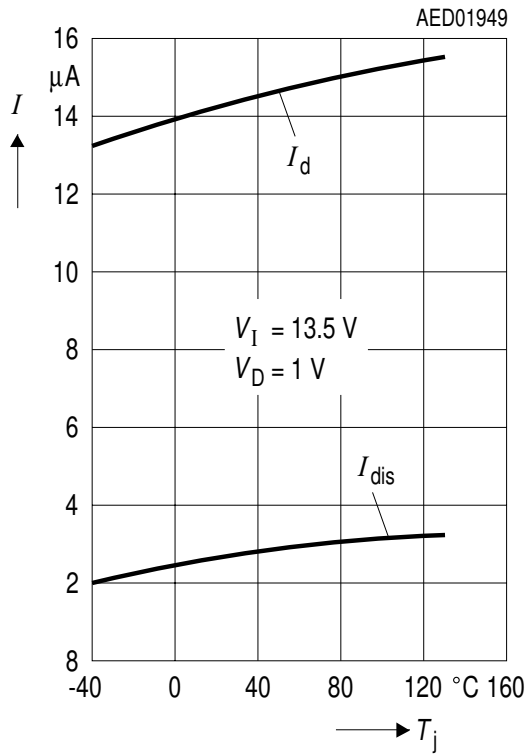

**Watchdog Pulse Time  $T_w$  versus Temperature  $T_j$**

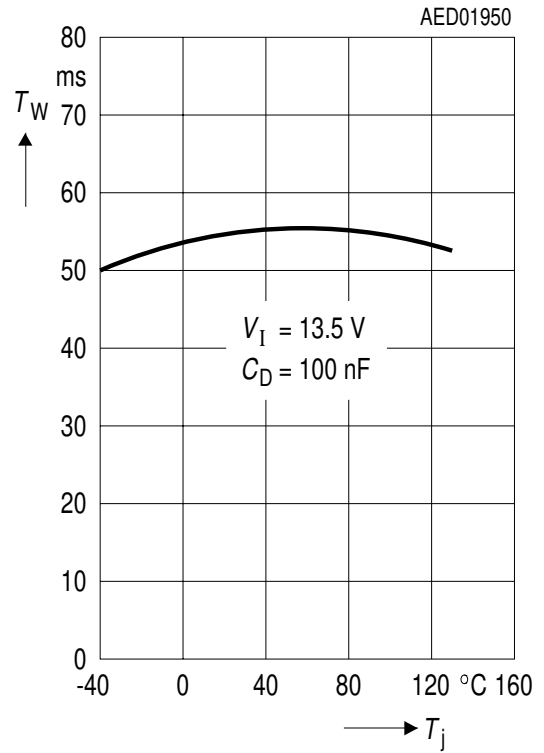

### Package Outlines

**P-TO220-7-11**  
(Plastic Transistor Single Outline Package)

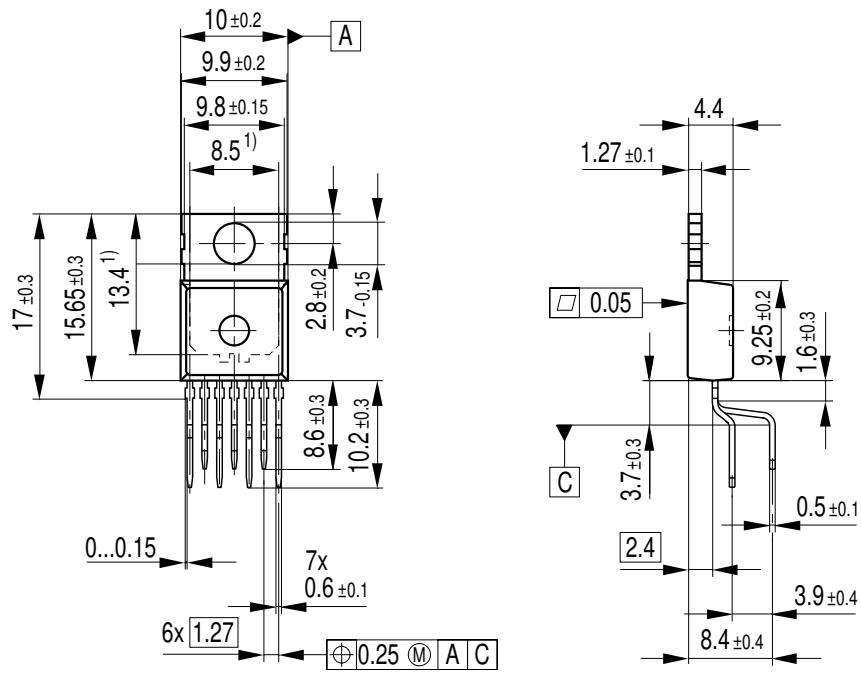

1) Typical  
All metal surfaces tin plated, except area of cut.

GPT09083

### Sorts of Packing

Package outlines for tubes, trays etc. are contained in our Data Book "Package Information".

Dimensions in mm

**P-TO220-7-12**  
 (Plastic Transistor Single Outline Package)

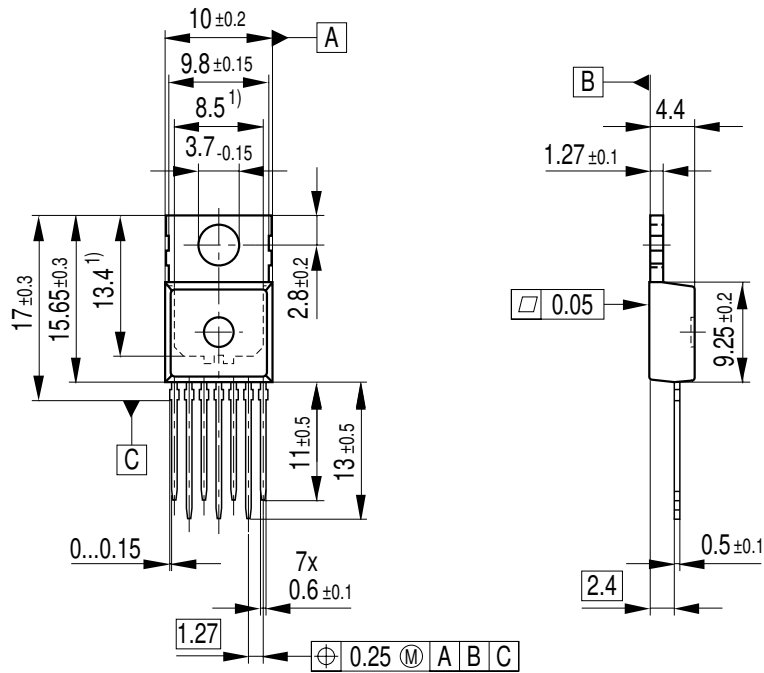

<sup>1)</sup> Typical  
 All metal surfaces tin plated, except area of cut.

GPT09084

**Sorts of Packing**

Package outlines for tubes, trays etc. are contained in our Data Book "Package Information".

Dimensions in mm

**P-TO263-7-1**  
(Plastic Transistor Single Outline Package)

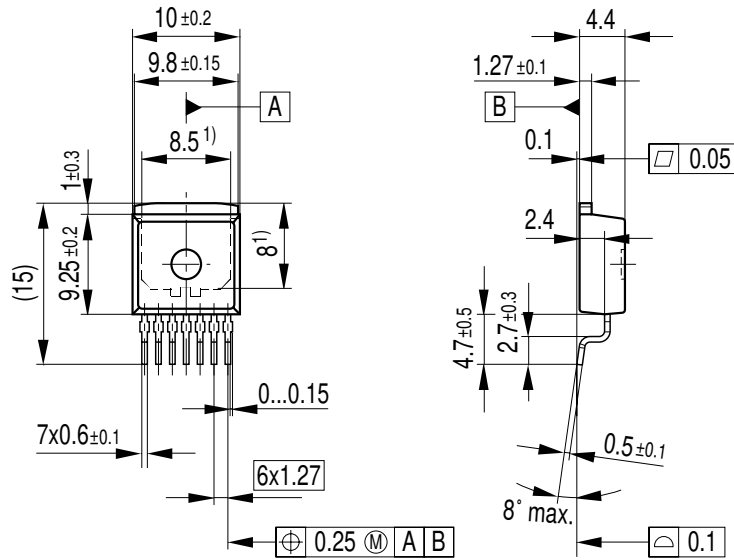

1) Typical  
All metal surfaces tin plated, except area of cut.

GPT09114

**Sorts of Packing**

Package outlines for tubes, trays etc. are contained in our Data Book "Package Information".

SMD = Surface Mounted Device

Dimensions in mm

**Edition 2000-02-14**

**Published by Infineon Technologies AG,  
St.-Martin-Strasse 53,  
D-81541 München, Germany**

**© Infineon Technologies AG 2000.  
All Rights Reserved.**

**Attention please!**

The information herein is given to describe certain components and shall not be considered as warranted characteristics.

Terms of delivery and rights to technical change reserved.

We hereby disclaim any and all warranties, including but not limited to warranties of non-infringement, regarding circuits, descriptions and charts stated herein.

Infineon Technologies is an approved CECC manufacturer.

**Information**

For further information on technology, delivery terms and conditions and prices please contact your nearest Infineon Technologies Office in Germany or our Infineon Technologies Representatives worldwide (see address list).

**Warnings**

Due to technical requirements components may contain dangerous substances. For information on the types in question please contact your nearest Infineon Technologies Office.

Infineon Technologies Components may only be used in life-support devices or systems with the express written approval of Infineon Technologies, if a failure of such components can reasonably be expected to cause the failure of that life-support device or system, or to affect the safety or effectiveness of that device or system. Life support devices or systems are intended to be implanted in the human body, or to support and/or maintain and sustain and/or protect human life. If they fail, it is reasonable to assume that the health of the user or other persons may be endangered.