



EVERSTAR

Jiangsu Everstar Electronics Co., Ltd.

Address: No.6 Xiangshan Rd, Tianmuhu Industry Park, Liyang City, Jiangsu Province, China

TEL: +86-519-87557772

FAX: +86-519-87557773

Http: www.everstarelect.com

DATA SHEET

ESL NO.. : ESS-5730UWDT-R80-WR

CUS NO. :

REV : A / 0

Producer: 张学斌

Auditor: 张帆

Approver: [Signature]

CUSTOMER'S APPROVAL : _____

DCC : _____

PACKAGE DIMENSIONS

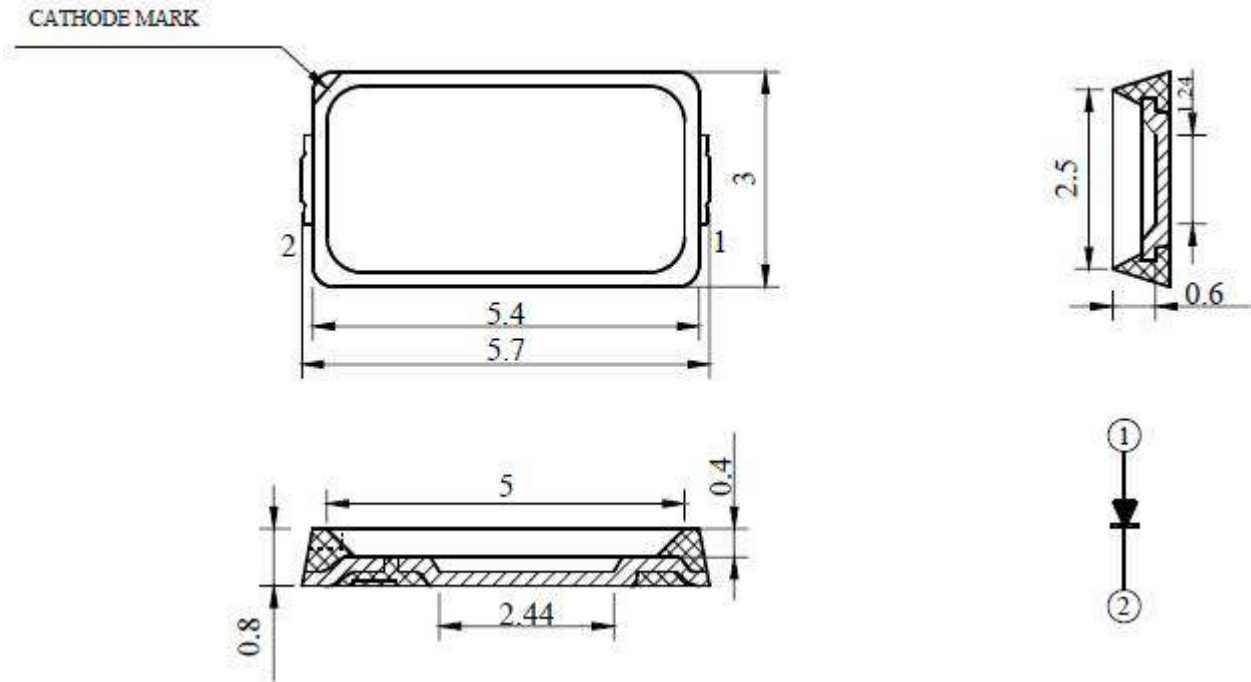

Note:

1. All Dimensions are in millimeters.
2. Tolerance is $\pm 0.25\text{mm}$ (0.010 "). Unless otherwise specified.



5730 SMD LED

ESS-5730UWDT-R80-WR

REV:A / 0

Absolute maximum ratings

Ta=25°C)

Parameter	Symbol	Value	Unit
Forward current	If	150	mA
Reverse voltage	Vr	5	V
Power dissipation	Pd	600	MW
Operating temperature range	Top	-40~+85	°C
Storage temperature range	Tstg	-40~+100	°C
Peak pulsing current (1/8 duty f=1KHz)	I _{fp}	300	mA

Electro-Optical characteristics

(TA=25°C)

Parameter	Test Condition	Symbol	Value			Unit
			Min	Typ	Max	
Color Temperature	If=150mA	CCT	4700		7000	K
Forward voltage	If=150mA	Vf	3.0	--	3.6	V
Light	If=150mA	ϕ	55	--	65	Lm
Color Rendering Index	If=150mA	CRI	80		--	/
Viewing angle at 50% IV	--	2 θ 1/2	--	120	--	Deg
Reverse current	Vr=5V	Ir	--	10	--	μ A

Typical photo electricity characteristic curve chart

Relative Luminous Intensity Vs. Wavelength Ta=25°C

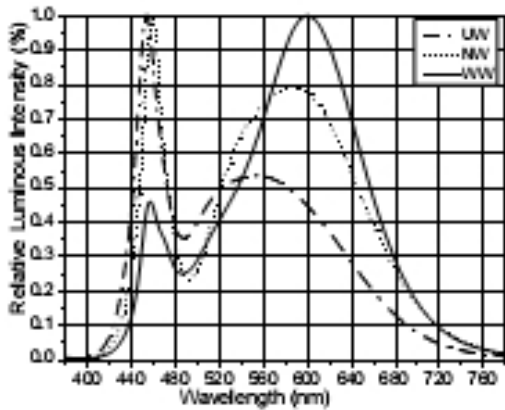

Forward Current vs Forward Voltage at Ta=25°C

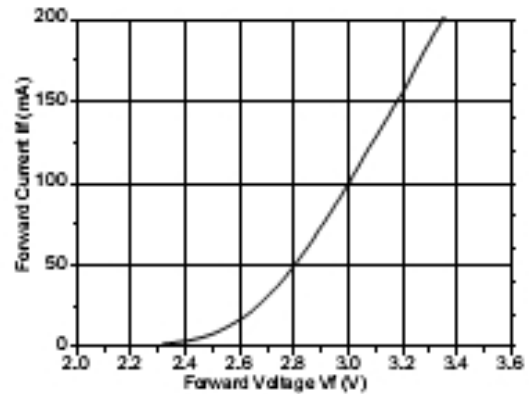

Forward Current Vs. Ambient Temperature

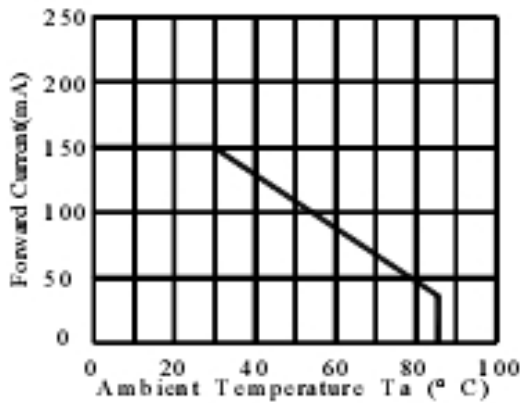

Forward Current Vs. Relative Luminosity Ta=25°C

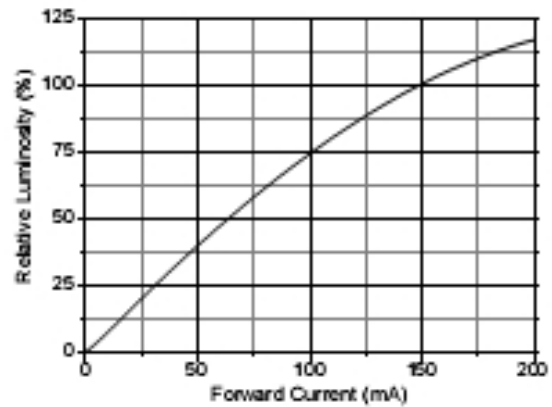

Relative Luminosity Vs. Ambient Temperature

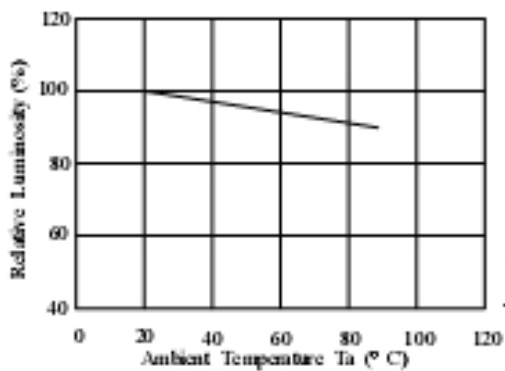

Radiation diagram

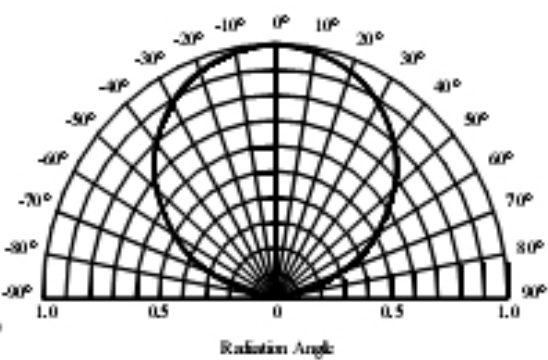



5730 SMD LED

ESS-5730UWDT-R80-WR

REV:A / 0

Typical photo electricity characteristic curve chart

CIE 1931 xy CHROMATICITY DIAGRAM

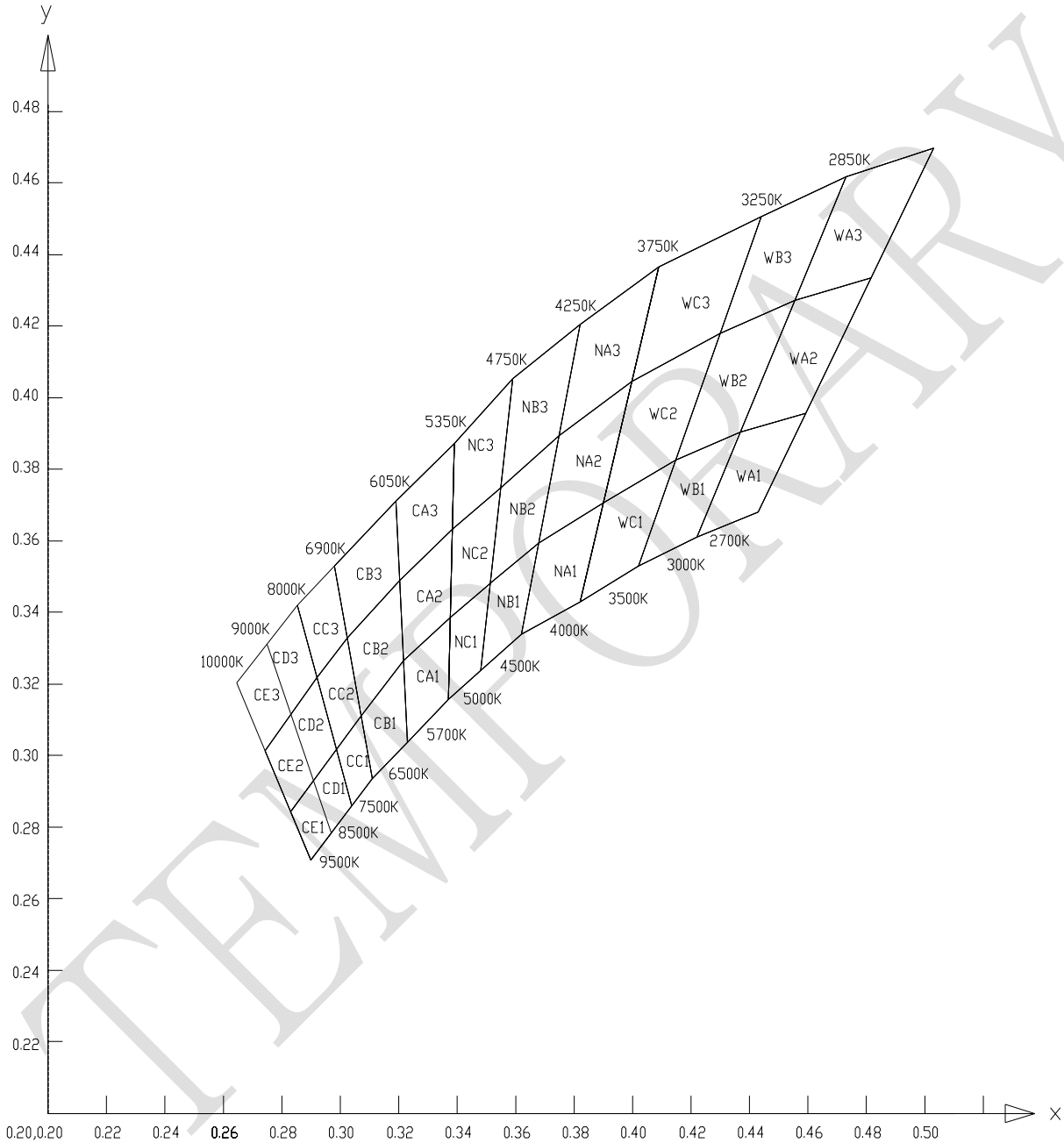



5730 SMD LED

ESS-5730UWDT-R80-WR

REV:A / 0

※※ BIN range

Forward voltage (tolerance is $\pm 0.05V$ @ $IF=150mA$):

BIN CODE	Min. (V)	Max. (V)
S	2.9	3.0
T	3.0	3.1
U	3.1	3.2
V	3.2	3.3
W	3.3	3.4
X	3.4	3.5

Luminous intensity (tolerance is $\pm 10%$ @ $IF=150mA$):

BIN CODE	Min.(lm)	Max.(lm)
B13	50	55
B14	55	60
B15	60	65

※ Reliability test items and conditions:

No.	Test Item	Test Conditions	Sample size	Ac/Re
1	Operation Life	Test If=DC60mA Temp: Room temperature Test time=1000hrs	22	0/1
2	High Temperature High Humidity	Temp. =+85°C RH=85%HR Test time=1000hrs	22	0/1
3	Thermal Shock	-35°C ~ +85°C 20min 10s 20min Test Time=300cycles	22	0/1
4	High Temperature Storage	High Temp. =+85°C Test time=1000hrs	22	0/1
5	Low Temperature Storage	Low Ta=-35°C Test time=1000hrs	22	0/1
6	Temperature Cycle	-35°C ~ +100°C 15min 5min 15min Test Time=300cycle	22	0/1
7	Reflow Soldering	Operation heating: 240°C(Max.), within 10seconds. (Max.)	22	0/1

※ Judgment criteria of failure for the reliability

- Iv: Below 50% of initial values
- Vf: Over 20% of upper limit value
- IR: Over 2 times of upper limit value



5730 SMD LED

ESS-5730UWDT-R80-WR

REV:A / 0

※ Precautions for use :

1. Customer must apply the current limiting resistor in the circuit so as to drive the LEDs within the rated current. Otherwise slight voltage shift maybe will cause big current change and burn out will happen.
2. Also, caution should be taken not to overload the LEDs with instantaneous high voltage at the turning ON and OFF of the circuit.
3. Storage:

3.1 Don't open the moisture proof bag before ready to use the LEDs.

3.2 The LEDs should be kept at 30°C or less and 60%RH or less before opening the package.

The max. storage period before opening the package is 1 year.

3.3 After opening the package, the LEDs should be kept at 30°C/35%RH or less, and it should

be used within 7 days.

3.4 If the LEDs be kept over the conditions of 3.4, baking is required before mounting.

Baking

condition as below: 60±5°C for 12 hrs.

4. Soldering condition:

4.1 Manual of soldering:

The temp. of the iron should be lower than 260°C and soldering within 3sec per solder-pad is to be observed.

4.2 Pb-free solder temp. -time profile

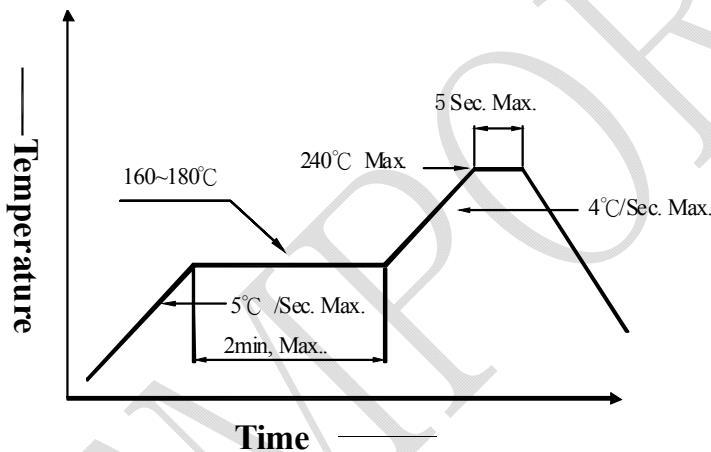

4.3 DIP soldering (Wave Soldering) temp. -time profile

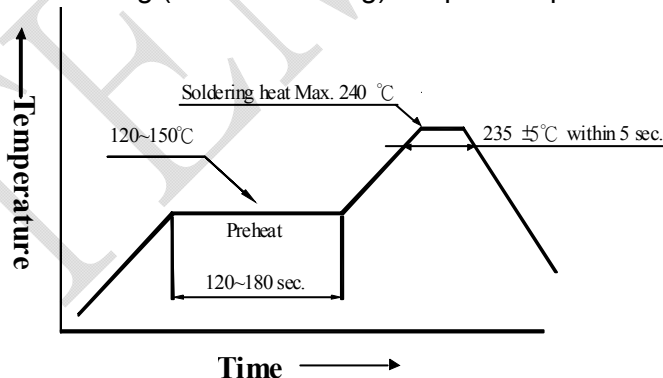

Note:

- a) Reflow soldering should not be done more than two times.
- b) Don't put stress on the LEDs when soldering.
- c) Don't warp the circuit board before it have been returned to normal ambient conditions after soldering.

Tape and Packaging

1、Tape leader and reel (1000±3 pcs/Reel)

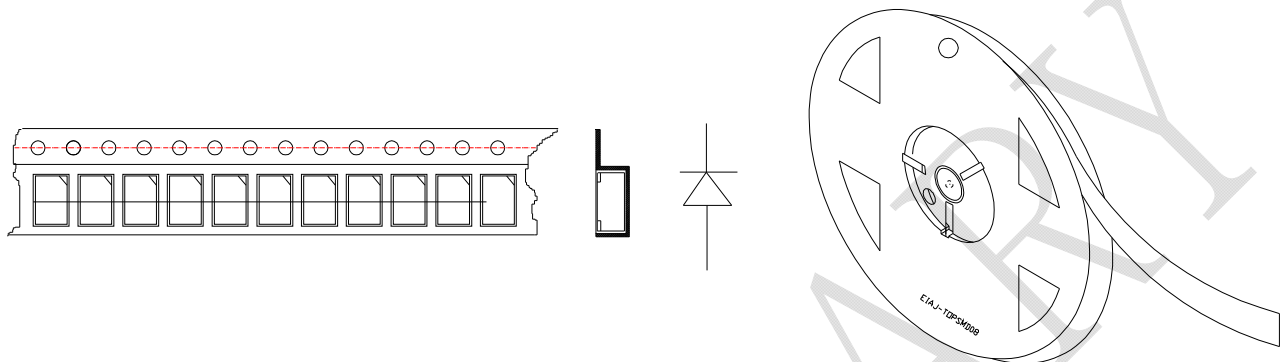

2、Packing

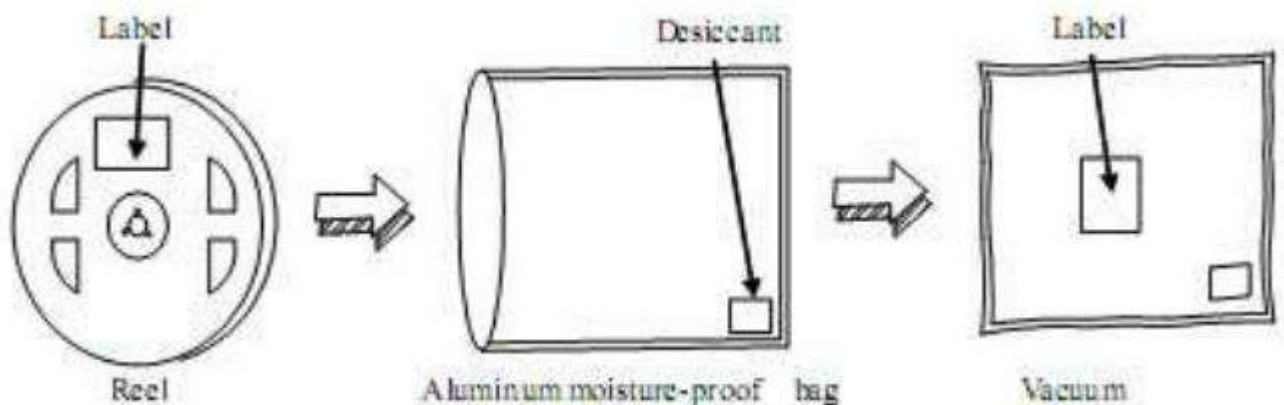

3、Storage:

- 1) 、 Don't open the moisture proof bag before the products are ready to use ◦
- 2) 、 Before opening the packing, the LED should be kept at 30℃ or less and 90RH or less
- 3) 、 After opening the moisture proof bag, should use the LED immediately, do not expose the led in air for a week.
- 4) 、 If the LEDs exceed the storage time or the moisture absorbability material has faded away, Backing treatment should be performed using the following conditions: 60+/-5℃ for 24 hours.