

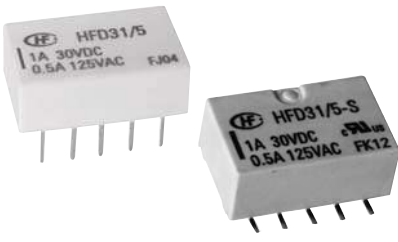

# HFD31

# SUBMINIATURE SIGNAL RELAY



**Features**

- Offers excellent board space savings
- Surge withstand voltage up to 1500V, meets FCC Part 68
- High contact capacity 1A 30VDC
- Low power consumption
- Single side stable and latching type available
- Single or double coil winding type available
- Class A insulation system
- Environmental friendly product (RoHS compliant)
- Outline Dimensions: (14.0 x 9.0 x 5.0) mm



File No.:E133481

## CONTACT DATA

Contact arrangement	2C
Contact resistance	100mΩ max. (at 0.1A 6VDC)
Contact material	Silver alloy+Gold clad
Contact rating (Res. load)	1A 30VDC 0.5A 125VAC
Max. switching current	1A
Max. switching voltage	125VAC/110VDC
Max. switching power	62.5VA / 30W
Min. applicable load <sup>1)</sup>	10mV 10μA
Mechanical endurance	1 x 10 <sup>8</sup> OPS
Electrical endurance	2 x 10 <sup>5</sup> OPS (at 1A 30VDC) 1 x 10 <sup>5</sup> OPS (at 0.5A 125VAC)

**Notes:** 1) Min. applicable load is reference value. Please perform the confirmation test with the actual load before production since reference value may change according to switching frequencies, environmental conditions and expected contact resistance and reliability.

## CHARACTERISTICS

Insulation resistance		1000MΩ (at 500VDC)
Dielectric strength	Between coil & contacts	1000VAC 1min
	Between open contacts	750VAC 1min
	Between contact sets	1000VAC 1min
Surge withstand voltage Between open contacts (10×160μs)		1500VAC (FCC part 68)
Operate time (Set time)		3ms max.
Release time (Reset time)		3ms max.
Ambient temperature		-40°C to 70°C
Humidity		5% to 85% RH
Vibration resistance	Functional	10Hz to 55Hz 3.0mm DA
	Destructive	10Hz to 55Hz 5.0mm DA
Shock resistance	Functional	490m/s <sup>2</sup>
	Destructive	980m/s <sup>2</sup>
Termination		DIP, SMT
Unit weight		Approx. 1.5g
Construction		Plastic sealed

**Notes:** The data shown above are initial values.

## COIL

Coil power	Single side stable	Approx. 140mW (24VDC: Approx. 200mW)
	1 coil latching	Approx. 100mW (24VDC: Approx. 150mW)
	2 coils latching	Approx. 200mW (24VDC: Approx. 300mW)

## SAFETY APPROVAL RATINGS

UL/CUL	1A 30VDC 0.5A 125VAC
--------	-------------------------

**Notes:** Only some typical ratings are listed above. If more details are required, please contact us.



HONGFA RELAY

ISO9001, ISO/TS16949, ISO14001, OHSAS18001, IECQ QC 080000 CERTIFIED

2012 Rev. 1.00

**COIL DATA**

at 23°C

**Single side stable**

Order Number	Nominal Voltage VDC	Pick-up Voltage VDC max.	Drop-out Voltage VDC min.	Coil Resistance $\Omega$	Nominal Power mW approx.	Max. Allowable Voltage VDC
HFD31/1.5	1.5	1.13	0.15	16 x (1±10%)	140	2.25
HFD31/2.4	2.4	1.8	0.24	41.3 x (1±10%)	140	3.6
HFD31/3	3	2.25	0.3	64.3 x (1±10%)	140	4.5
HFD31/4.5	4.5	3.38	0.45	145 x (1±10%)	140	6.7
HFD31/5	5	3.75	0.5	178 x (1±10%)	140	7.5
HFD31/6	6	4.5	0.6	257 x (1±10%)	140	9
HFD31/9	9	6.75	0.9	579 x (1±10%)	140	13.5
HFD31/12	12	9	1.2	1028 x (1±10%)	140	18
HFD31/24	24	18	2.4	2880 x (1±10%)	200	36

**1 coil latching**

Order Number	Nominal Voltage VDC	Set Voltage VDC max.	Reset Voltage VDC max.	Coil Resistance $\Omega$	Nominal Power mW approx.	Max. Allowable Voltage VDC
HFD31/1.5-L1	1.5	1.13	1.13	22.5 x (1±10%)	100	2.25
HFD31/2.4-L1	2.4	1.8	1.8	58 x (1±10%)	100	3.6
HFD31/3-L1	3	2.25	2.25	90 x (1±10%)	100	4.5
HFD31/4.5-L1	4.5	3.38	3.38	203 x (1±10%)	100	6.7
HFD31/5-L1	5	3.75	3.75	250 x (1±10%)	100	7.5
HFD31/6-L1	6	4.5	4.5	360 x (1±10%)	100	9
HFD31/9-L1	9	6.75	6.75	810 x (1±10%)	100	13.5
HFD31/12-L1	12	9	9	1440 x (1±10%)	100	18
HFD31/24-L1	24	18	18	3840 x (1±10%)	150	36

**2 coils latching**

Order Number	Nominal Voltage VDC	Set Voltage VDC max.	Reset Voltage VDC max.	Coil Resistance $\Omega$	Nominal Power mW approx.	Max. Allowable Voltage VDC
HFD31/1.5-L2	1.5	1.13	1.13	11.3 x (1±10%)	200	2.25
HFD31/2.4-L2	2.4	1.8	1.8	29 x (1±10%)	200	3.6
HFD31/3-L2	3	2.25	2.25	45 x (1±10%)	200	4.5
HFD31/4.5-L2	4.5	3.38	3.38	101 x (1±10%)	200	6.7
HFD31/5-L2	5	3.75	3.75	125 x (1±10%)	200	7.5
HFD31/6-L2	6	4.5	4.5	180 x (1±10%)	200	9.0
HFD31/9-L2	9	6.75	6.75	405 x (1±10%)	200	13.5
HFD31/12-L2	12	9	9	720 x (1±10%)	200	18
HFD31/24-L2	24	18	18	1920 x (1±10%)	300	36

**Notes:** 1) When user's requirements can't be found in the above table, special order allowed.

2) In case 5V of transistor drive circuit, it is recommended to use 4.5V type relay, and 3V to use 2.4V type relay.

## ORDERING INFORMATION

<b>HFD31 /</b>		<b>24</b>	<b>-L</b>	<b>S</b>	<b>R</b>	<b>(XXX)</b>
<b>Type</b>						
<b>Coil voltage</b>	1.5, 2.4, 3, 4.5, 5, 6, 9, 12, 24VDC					
<b>Sort</b>	L1: 1 coil latching		L2: 2 coils latching			
	Nil: Single side stable					
<b>Terminal type</b>	S: Standard SMT		Nil: DIP			
<b>Packing style</b>	R: Tape and reel packing (Only for SMT type) <sup>1)</sup>				Nil: Tube packing	
<b>Customer special code</b>						

Notes: 1) For the R type, the letter "R" will only be printed on packing tag and will not appear on relay cover.

## OUTLINE DIMENSIONS, WIRING DIAGRAM AND PC BOARD LAYOUT

Unit: mm

Outline Dimensions

PCB Layout  
(Bottom view)

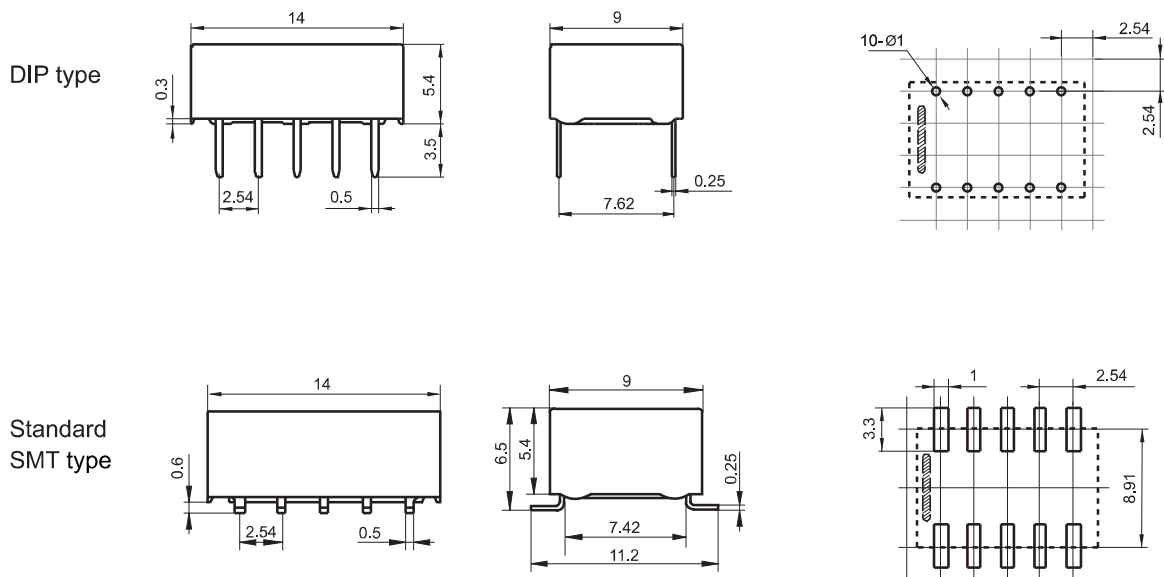

Remark: 1) In case of no tolerance shown in outline dimension: outline dimension  $\leq 1\text{mm}$ , tolerance should be  $\pm 0.2\text{mm}$ ; outline dimension  $> 1\text{mm}$  and  $\leq 5\text{mm}$ , tolerance should be  $\pm 0.3\text{mm}$ ; outline dimension  $> 5\text{mm}$ , tolerance should be  $\pm 0.4\text{mm}$ .

2) The tolerance without indicating for PCB layout is always  $\pm 0.1\text{mm}$ .

3) The width of the gridding is 2.54mm.

# OUTLINE DIMENSIONS, WIRING DIAGRAM AND PC BOARD LAYOUT

Unit: mm

## Wiring Diagram (Bottom view)

Single side stable

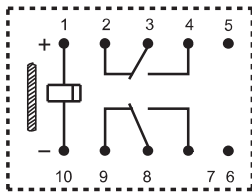

Deenergized condition

1 coil latching

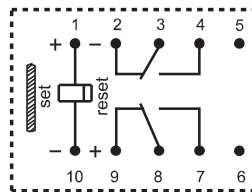

Reset condition

2 coils latching

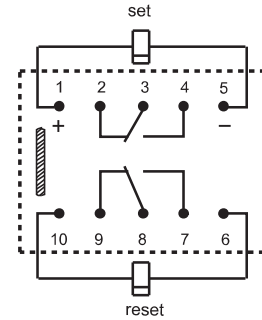

Reset condition

# TAPE & REEL PACKING CONSTRUCTION AND DIMENSION

Unit: mm

Reel Dimensions

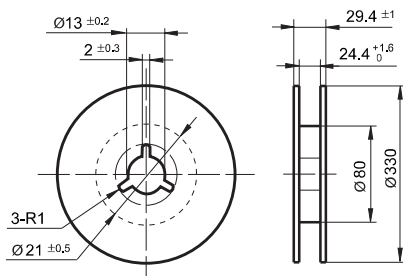

Direction of Relay Insertion

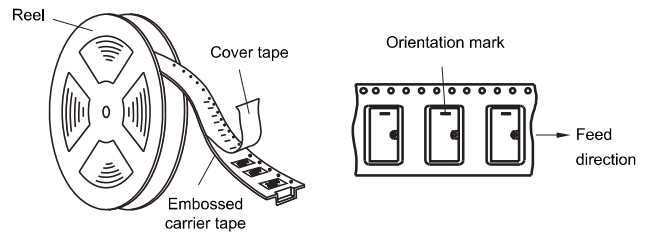

- Notes:** 1) Packing: 600pcs/reel, 4 reels/carton.  
2) MOQ for reel packing is 600pcs.

Tape Dimensions

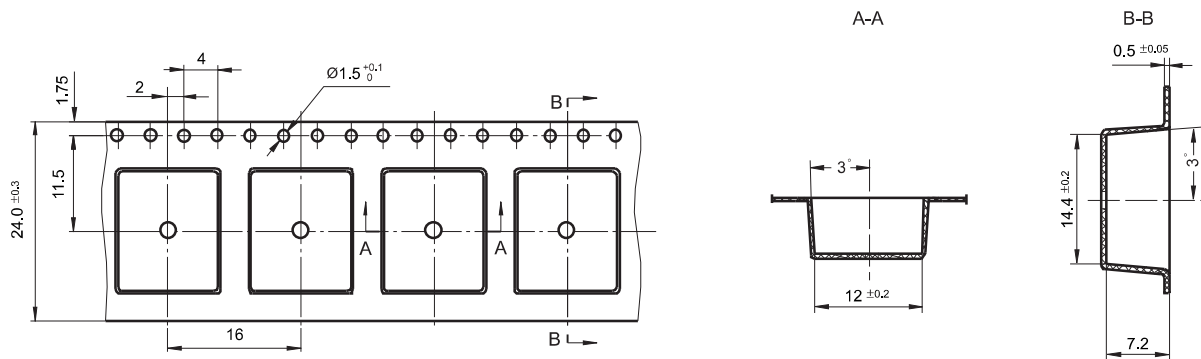

## RECOMMENDED SOLDERING CONDITIONS

Temperature/Time profile of Reflow Soldering see below:

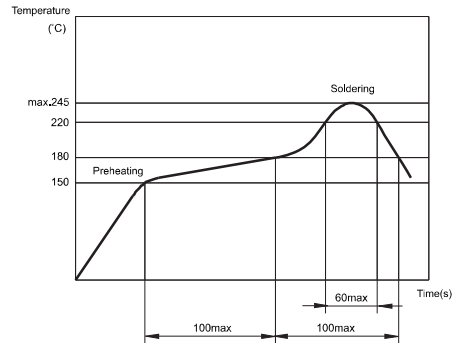

- Notes:** 1) Temperature profile shows Printed Circuit Board surface temperature on the relay terminal portion.  
2) Please check the actual soldering condition to use other method except above mentioned temperature profiles.

## CHARACTERISTIC CURVES

MAXIMUM SWITCHING POWER

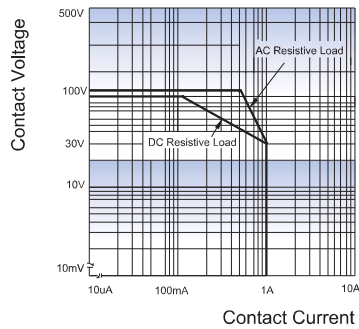

ENDURANCE CURVE

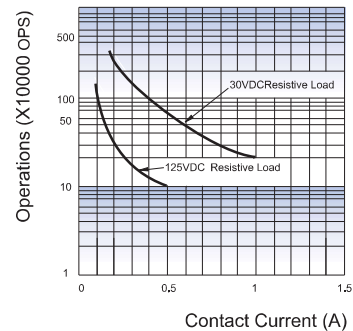

### Notice

- 1) This relay is highly sensitive polarized relay, if correct polarity is not applied to the coil terminals, the relay does not operate properly.
- 2) To avoid using relays under strong magnetic field which will change the parameters of relays such as pick-up voltage and drop-out voltage.
- 3) Relay is on the "reset" status when being released from stock, with the consideration of shock risen from transit and relay mounting, it should be changed to the "set" status when application(connecting to the power supply). Please reset the relay to "set" or "reset" status on request.
- 4) In order to maintain the "set" or "reset" status, energized voltage to coil should reach the rated voltage, impulse width should be more than 5 times of "set" or "reset" time.
- 5) For 2 coil latching relay, do not energize voltage to "set" coil and "reset" coil simultaneously.
- 6) The relay may be damaged because of falling or when shocking conditions exceed the requirement.
- 7) Regarding the plastic sealed relay, we should leave it cooling naturally until below 40°C after welding, then clean it and deal with coating, remarkably the temperature of solvents should also be controlled below 40°C. Please avoid cleaning the relay by ultrasonic, avoid using the solvents like gasoline, Freon, and so on, which would affect the configuration of relay or influence the environment.
- 8) About preferable condition of operation, storage and transportation, please refer to "Explanation to terminology and guidelines of relay".

### Disclaimer

This datasheet is for the customers' reference. All the specifications are subject to change without notice.

We could not evaluate all the performance and all the parameters for every possible application. Thus the user should be in a right position to choose the suitable product for their own application. If there is any query, please contact Hongfa for the technical service. However, it is the user's responsibility to determine which product should be used only.

© Xiamen Hongfa Electroacoustic Co., Ltd. All rights of Hongfa are reserved.