

# 6 mm carbon potentiometer PT-6

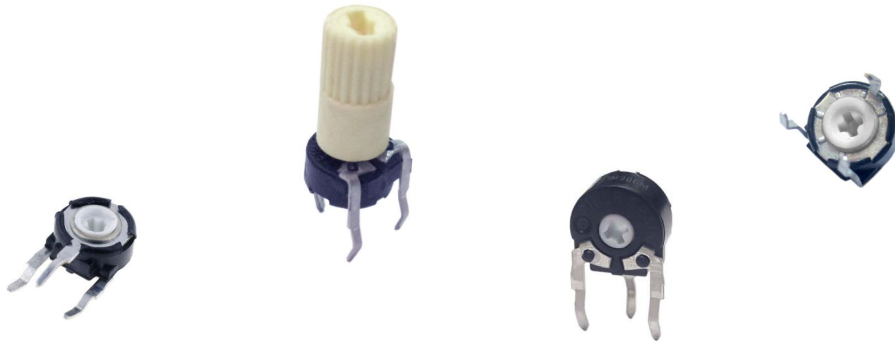

## Mechanical specifications

Mechanical rotation angle		$235^\circ \pm 5^\circ$
Electrical rotation angle		$200^\circ \pm 20^\circ$
Torque	rotational stop	0.2 to 2 Ncm. (0.3 to 2.7 in - oz)
Stop torque		> 4 Ncm. (>5.6 in-oz)
Life*		Up to 10Kcycles

## Electrical specifications

Range of values *		$220\Omega \leq R_n \leq 5M\Omega$ (Decad. 1.0 - 2.0 - 2.2 - 2.5 - 4.7 - 5.0)
Tolerance *	$220\Omega \leq R_n \leq 1M\Omega$ $1M\Omega \leq R_n \leq 5M\Omega$	$\pm 20\%$ $\pm 30\%$
Max. voltage		100 VDC (lin) 50 VDC (no lin)
Nominal power 50°C (122°F) (see power rating curve)		0.1 W (lin) 0.05 W (no lin)
Taper *		Lin; Log; Alog (Log. & Alog. only $R_n > 1K$ )
Residual resistance*		$\leq 0.5\% R_n$ (5Ω min.)
Equivalent noise resistance		$\leq 3\% R_n$ (3Ω min.)
Operating temperature **		-25°C to +70°C (-13°F to + 158°F)

\* Others: check availability.

\*\* Up to 85°C depending on application.

## Main features

- Carbon resistive element.
- IP54 protection according to IEC 60529.
- Polyester substrate.
- SMD version available (see PS-6 datasheet).
- Wiper positioned at initial, 50% or fully clockwise.
- Also upon request:
  - Supplied in magazines for automatic insertion.
  - Long life model (10Kcycles).
  - Housing available in self extinguishable plastic (UL94V0).
  - Mechanical detents.

## Description

The PT-6 potentiometer offers control where frequent adjustment is required. The shaftless design allows for employment of different engagement mechanisms, such as a customized shaft, a motor control or a human interface adjustment.

This potentiometer can also control variable outputs including frequency, change in motor speed or volume.

Typical applications include test and measurement equipment, consumer electronics, appliances, timer relays, robotics, motion controllers, home and building automation and medical equipment control panels.

This datasheet shows you the basics of the PT-6 potentiometer that is quite versatile and easy to tailor. Do not hesitate to contact Piher for advice.



# 6 mm carbon potentiometer PT-6

## How to order

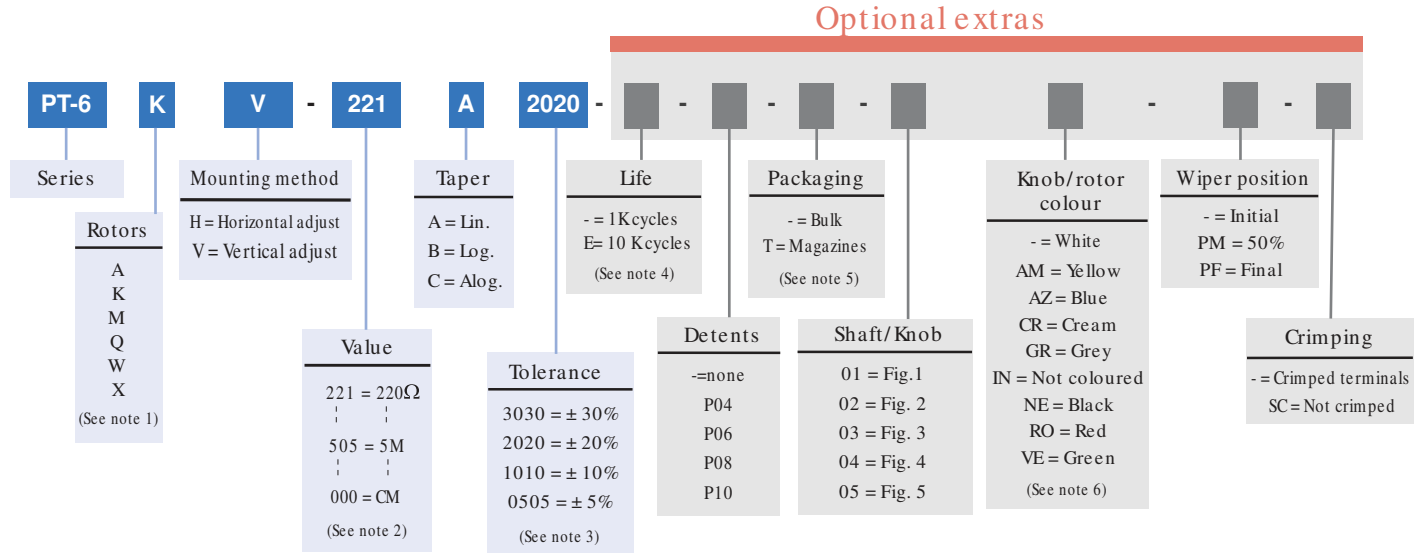

NOTES:

(1) Adjust. type: «X» is only available with horizontal adjusting method.

(2) Value: - Code:

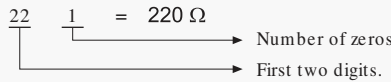

- 000 = CM = switch SPDT version (contact us for further information)

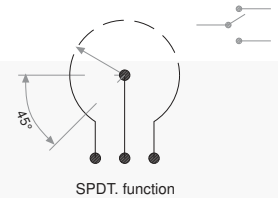

Resistance Ω	100	200	220	250	470	500	1K	2K	2.2K	2.5K	4.7K	5K	10K	20K	22K	25K	47K	50K	100K	200K	220K	250K	470K	500K	1M	2M	2.5M	4.7M	5M
How to order code	101	201	221	251	471	501	102	202	222	252	472	502	103	203	223	253	473	503	104	204	224	254	474	504	105	205	255	475	505
Standard tolerance	30%														20%										30%				

(3) Tolerance (non standard, custom): check availability..... Code eg.:  $\begin{matrix} +7 \\ -5 \end{matrix} = \begin{matrix} 07 \\ 05 \end{matrix}$  Negative tolerance / Positive tolerance

(4) Life: • Standard = 1000 cycles • Long = 10Kcycles (non-detented models)

(5) Only for “V” mounting method. “W” rotor with shaft Fig. 2 is not available in magazines .

(6) Potentiometer without knob or shaft, only the rotor. Potentiometer with knob or shaft, only the knob/shaft. The default colour for the knob and rotor is white.

Online product configurator: <https://piher.net/configurator/2017/08/24/pt6-6-configurator-potentiometer/>

### How to order examples

#### PT6KH-103A2020

6mm potentiometer with rotor “K” (cross shape), H mounting method (horizontal adjustment), 10Kresistive value, 20% resistive tolerance and crimped terminals.

#### PT6WV-104A1010-5NE-SC

6mm potentiometer with factory pre-inserted knob, V mounting method (vertical adjustment), 100Kresistive value, 10% resistive tolerance, black knob ref. 6148 and straight terminals (not crimped).

### Standard default options

Mechanical life	1000 cycles
Crimping	Yes
Packing	Bulk
Rotor colour	White
Wiper send position	Initial
Knob colour	White

# 6 mm carbon potentiometer PT-6

## Rotors

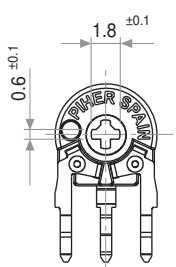

**K**  
Cross slot thru hole

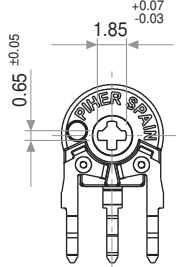

**Q**  
Cross slot thru hole

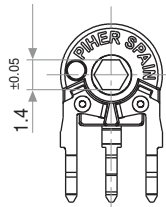

**M**  
Hexagonal thru hole

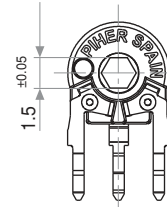

**A**  
Cross slot thru hole

Default delivery is at initial position. Wipers are shown positioned at 50% for the picture.

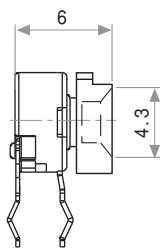

**X** = Adjustable from collector side

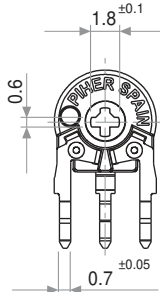

**W** = Adjustable from terminal side

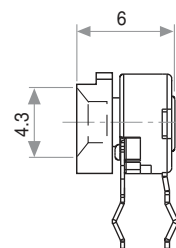
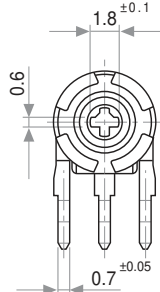

With inserted knob / shaft.

Default knob is ref. 5155 white.

## Mounting methods. Dimensions

V = horizontal mounting – vertical adjustment

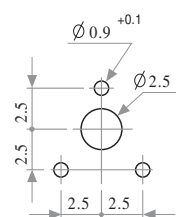
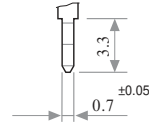
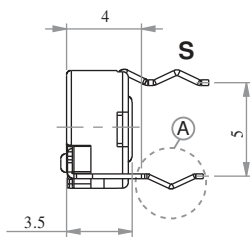
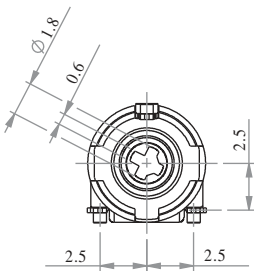

H = vertical mounting – horizontal adjustment

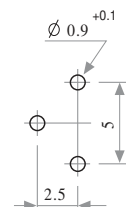
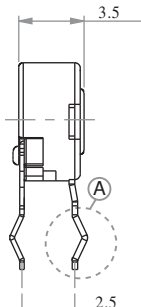
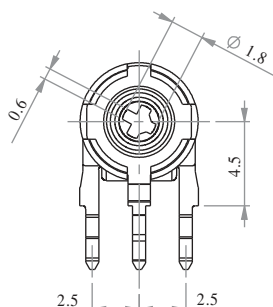

# 6 mm carbon potentiometer PT-6



Download the STEP file here:  
<https://piher.net/piher/?p=894>

## Crimped terminals (detail A)

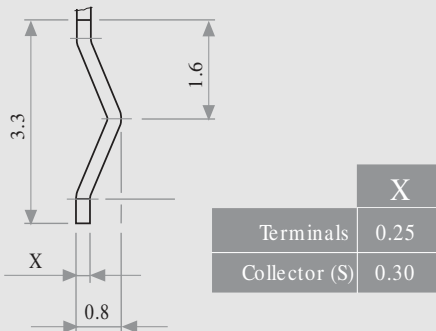

This is the default terminals type.

## Not-crimped terminals dimensions

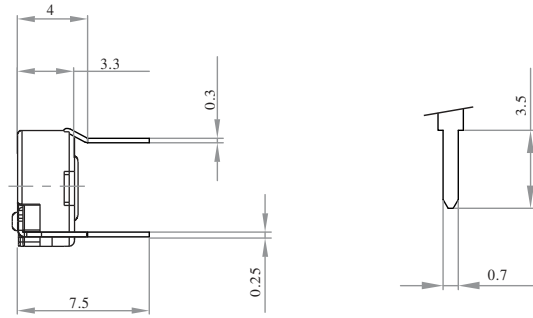

Please indicate "SC" at the end of the part number for this version.

## SMD versions

SMD/ SMT version available. See PS-6 and N-6 datasheets at: [www.piher.net](http://www.piher.net)

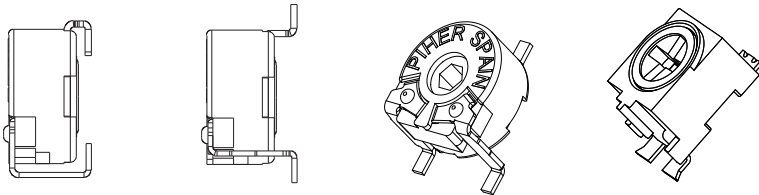

## Standard Tapers

A = Linear  
B = Log.  
C = Alog.

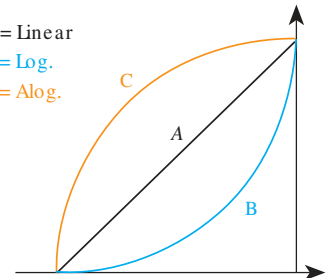

## Detents / stop positions

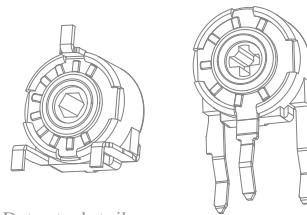
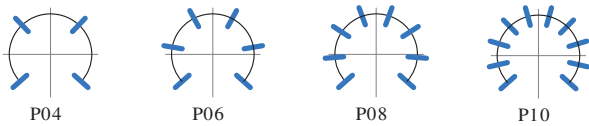

Detents details

— Relative detent positions along the mechanical travel.

### NOTES FOR DETENTED VERSIONS

- (1) All detented versions will be studied case by case. Contact Piher for leadtimes and availability.
- (2) Others: check availability. Unless otherwise specified the detents are evenly spaced (using the end points as reference).  
  
For more than 10 detents versions please contact Piher for more information.
- (3) Standard mechanical life: 100 cycles.
- (4) Long life versions are available under request. Contact Piher for more information.
- (5) Detent torque can vary from 1.2 to 2.5 times the standard potentiometer torque.

# 6 mm carbon potentiometer PT-6

## Knobs/Shfts

By default shafts, knobs & thumbwheels are delivered unassembled.

Mounted shafts, knobs & thumbwheels are delivered at random position. Custom positioning available.

If you wish to use your own plastic shaft/knob/actuator please contact Piher for advice about compatible materials.

Ref.: 5155 / Fig. 1

Default knob. Standard colour: white.

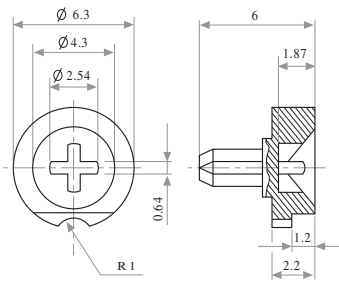

Ref.: 6132 / Fig. 2

Shaft. Not suitable for magazine packaging

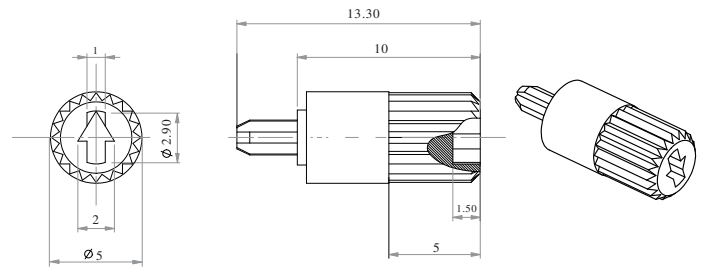

Ref.: 5141 / Fig. 3

Colour: grey. For other colours check availability.

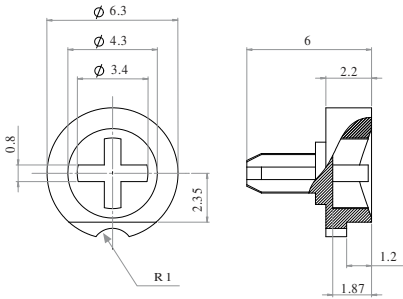

Ref.: 6172 / Fig. 4

Colour: grey. For other colours check availability.

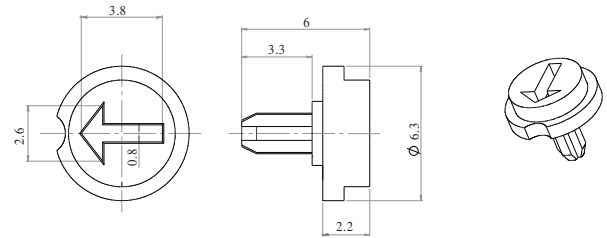

Ref.: 6148 / Fig. 5

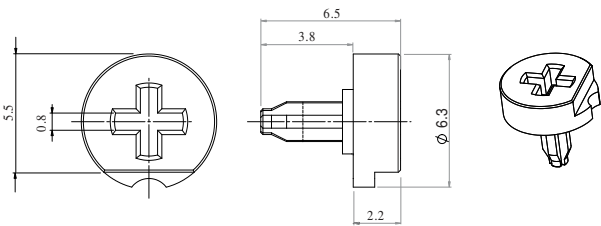

Ref.: 6160 / Fig. 6

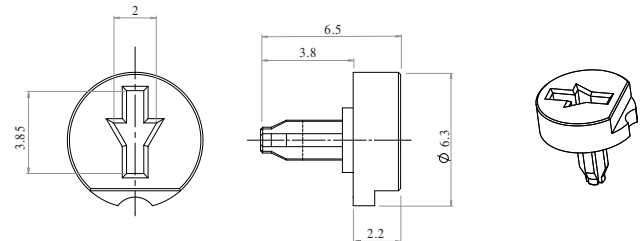

## Positioning

Default position = CCW

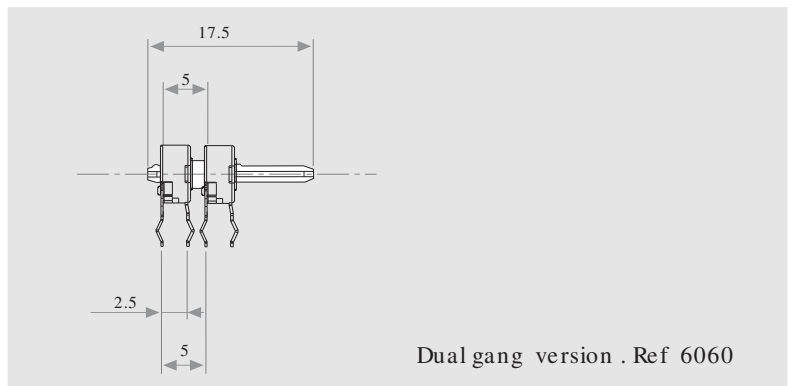
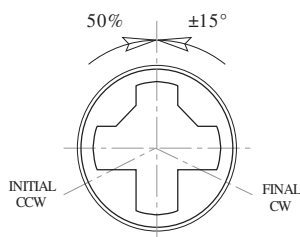

Dual gang version . Ref 6060

# 6 mm carbon potentiometer PT-6

## Packaging

### BOXES / BULK

Model	Units per box
-------	---------------

All 1.000



### AUTOMATIC INSERTION

Magazines	Units per magazine
-----------	--------------------

PT-6 V & PT-6 WV 80 Pieces

Magazines for PT-6 V with or without crimping.

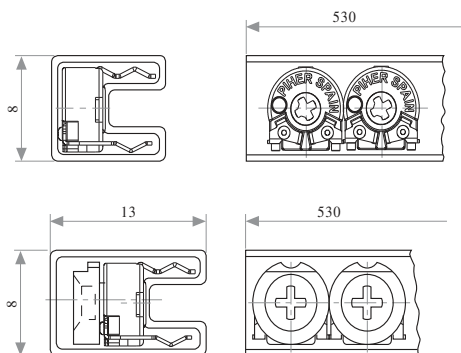

## Tests

### Typical variations

Electrical life	1.000 h. @ 50° C; 0.25 W	±5 %
Mechanical life (cycles)	1000 @ 10 CPM ...15 CPM	±3 % (Rn < 1 M )
Temperature coefficient	-25° C; +70° C	±300 ppm (Rn <100 K)
Thermal cycling	16 h. @ 85° C; 2h. @ -25° C	±2.5 %
Damp heat	500 h. @ 40° C @ 95% HR	±5 %
Vibration (for each plane,XYZ)	2 h. @ 10 Hz. ... 55 Hz.	±2 %

Out of range values may not comply these results

## Disclaimer

The product information in this catalogue is for reference purposes. Please contact Piher for the most up to date and accurate design information.

Piher Sensors & Controls S.A., its affiliates, agents, and employees, and all persons acting on its or their behalf (collectively, "Piher"), disclaim any and all liability for any errors, inaccuracies or incompleteness contained herein or in any other disclosure relating to any product described herein.

Piher disclaims any and all liability arising out of the use or application of any product described herein or of any information provided herein to the maximum extent permitted by law. The product specifications do not expand or otherwise modify Piher's terms and conditions of sale, including but not limited to the warranty expressed therein, which apply to these products.

No licence, express or implied, by estoppel or otherwise, to any intellectual property rights is granted by this document or by any conduct of Piher.

The products shown herein are not designed for use in medical, life-saving, or life-sustaining applications unless otherwise expressly indicated. Customers using or selling Piher products not expressly indicated for use in such applications do so entirely at their own risk and agree to fully indemnify Piher for any damages arising or resulting from such use or sale. Please contact authorised Piher personnel to obtain written terms and conditions regarding products designed for such applications.

Product names and markings noted herein may be trademarks of their respective owners.

Information contained in and/or attached to this catalogue may be subject to export control regulations of the European Community, USA, or other countries. Each recipient of this document is responsible to ensure that usage and/or transfer of any information contained in this document complies with all relevant export control regulations. If you are in any doubt about the export control restrictions that apply to this information, please contact the sender immediately. For any Piher Exports, Note: All products / technologies are EAR99 Classified commodities. Exports from the United States are in accordance with the Export Administration Regulations. Diversion contrary to US law is prohibited.

Piher is an Amphenol™ company.

All Piher products can be adapted to meet customer's requirements.

Please always use the latest updated datasheets and 3D models published at our website [www.piher.net](http://www.piher.net).

## Piher Sensing Systems

Potentiometers | Hall effect contactless sensors | Inductive sensors  
Printing electronics | Value added assemblies

## Recommended connections

Piher potentiometer's recommended connection circuit for a position sensor or control application. (voltage divider circuit electronic design)

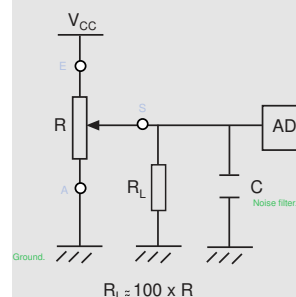

## Power rating curve

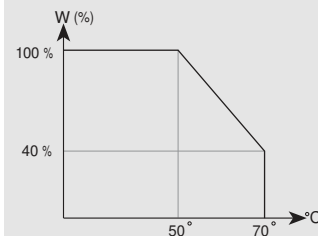

## Contact

Piher Sensing Systems  
Polígono Industrial Municipal  
Vial T2 Nº 22  
31500 Tudela - Spain  
Tel: +34-948-820450

[sales@piher.net](mailto:sales@piher.net)

[www.piher.net](http://www.piher.net)

