

FILE AMEND NOTE	DATE	REV.
ORIGINAL EDITION	2012/10/24	A/0

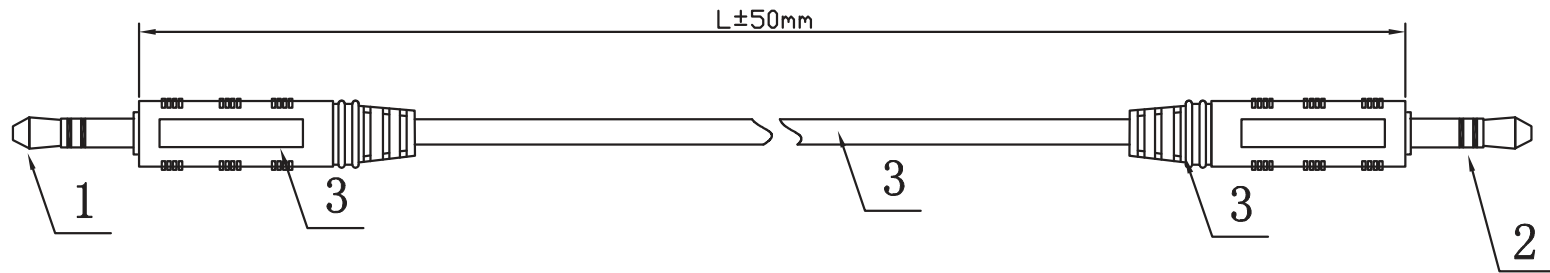

SPECIFICATION

NO.	ITEM NO.	EAN CODE:	L
1	CA1048	4052792008821	0,2m
2	CA1049	4052792008838	1,0m
3	CA1050	4052792008845	2,0m
4	CA1051	4052792008852	3,0m
5	CA1052	4052792008869	5,0m
6	CA1053	4052792008876	10,0m

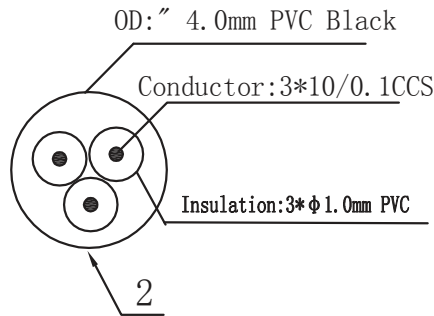

WIRING DIAGRAM

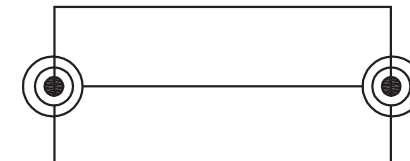

3.5stereo Male black

3.5stereo Male black

NOTE:

Electrical test
100% open short & miss wire test;

MATERIAL LIST

⑦	PRINTING			
⑥	POLY BAG	PE, COLOR: TRANSPARENT	1	
⑤	CABLE	3C AUDIO CABLE Cold Black	L	
④	MOLD HOOD	PVC 45P Cold black	1	
③	MOLD HOOD	PVC 45P Cold black	1	
②	CONNECTOR	3.5STEREO Male NI	1	
①	CONNECTOR	3.5STEREO Male NI	1	
No.	PART NAME	DESCRIPTION	QTY	REMARK

NOTE:

1. TESTING: 100% OPEN AND SHORT AND MISWIRE TEST.
2. INSULATION RESISTANCE: 100Meg Ohm.
3. WITHSTAND VOLTAGE: 500 VOLTS RMS, 1 MINUTE.
4. OPERATING TEMPERATURE RANGE: -20 ! TO + 75 ! .
5. 100% RoHS COMPLIANT.

DRAW No.	NAME	Audio cable, 2X 3,5mm male, stereo,		
CUSTOMER	MAPE	TOLERANCE		
CUSTOMER No.	2direct GmbH	X.	1.00	
		X.X	0.50	
APPROVE BY	CHECK BY	DRAW BY	SCALE	MM
			PAGE	1/2

FILE AMEND NOTE	DATE	REV.
ORIGINAL EDITION	2012/10/24	A/0

PACKING DRAW



1PCS/BAG

⑥

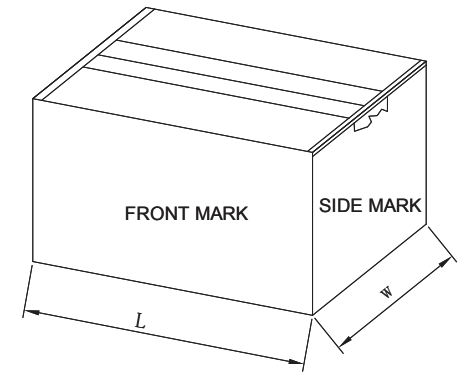
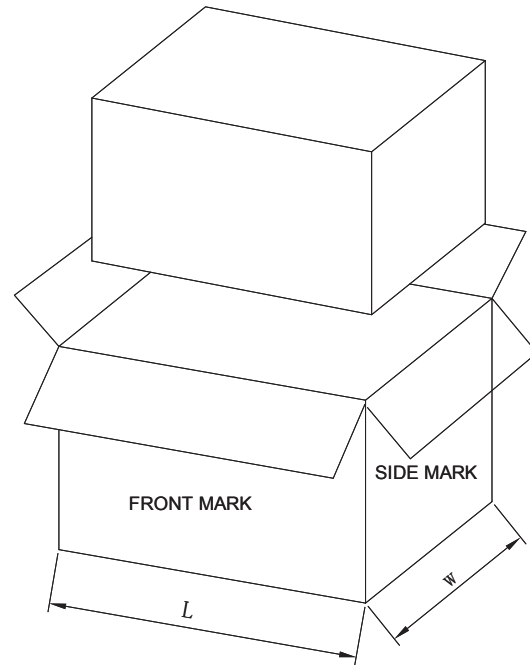
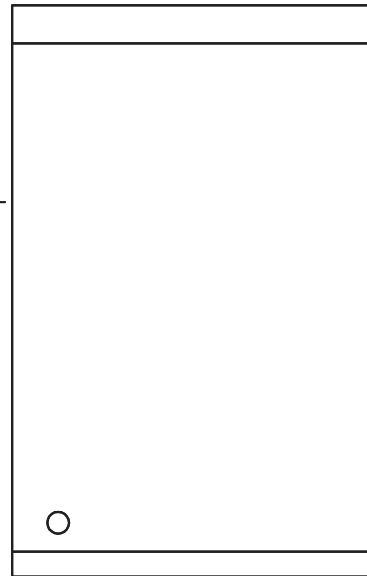

!# shaped packaging
three packaging tape

STICKER

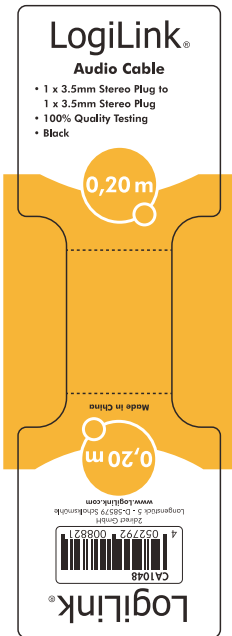

Pantone 1235C, Black
Size: 48x150 mm R= 2mm
材質: 80P銅版紙, 上亮PP(光膠)

OUTER CARTON
FRONT MARK:

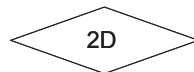

GERMANY
C/NO.:DW 01,02...
MADE IN CHINA

OUTER CARTON
SIDE MARK:

PO NO.:
ITEM NO.:
QTY: PCS
N.W: KGS
G.W: KGS
Dimension:
EAN CODE:

NOTE:

Electrical test
100% open short & miss wire test;

DRAW No.	NAME	Audio cable, 2X 3,5mm male, stereo,		
CUSTOMER	MAPE	TOLERANCE		
CUSTOMER No. 2direct GmbH		X.	1.00	
APPROVE BY	CHECK BY	X.X	0.50	
	DRAW BY	SCALE	MM	
		PAGE	2/2	

No.	PART NAME	DESCRIPTION	QTY	REMARK
-----	-----------	-------------	-----	--------