



### Features :

- Universal AC input / Full range (up to 295VAC)
- Protections: Short circuit / Over current / Over voltage / Over temperature
- Cooling by free air convection
- Built-in constant current limiting circuit with adjustable OCP level
- Fully isolated plastic case with IP64 level
- Built-in active PFC function
- IP64 design for indoor or outdoor installations
- Pass LPS
- Class II power unit, no FG
- 100% full load burn-in test
- High reliability
- Suitable for LED lighting and moving sign applications (Note.2)
- Compliance to worldwide safety regulations for lighting
- 2 years warranty



### SPECIFICATION

MODEL	PLN-30-9	PLN-30-12	PLN-30-15	PLN-30-20	PLN-30-24	PLN-30-27	PLN-30-36	PLN-30-48	
OUTPUT	DC VOLTAGE	9V	12V	15V	20V	24V	27V	36V	48V
	CONSTANT CURRENT REGION Note.6	6.3 ~ 9V	8.4 ~ 12V	10.5 ~ 15V	14 ~ 20V	16.8 ~ 24V	18.9 ~ 27V	25.2 ~ 36V	33.6 ~ 48V
	RATED CURRENT	3.3A	2.5A	2A	1.5A	1.25A	1.12A	0.84A	0.63A
	CURRENT RANGE	0 ~ 3.3A	0 ~ 2.5A	0 ~ 2A	0 ~ 1.5A	0 ~ 1.25A	0 ~ 1.12A	0 ~ 0.84A	0 ~ 0.63A
	RATED POWER	29.7W	30W	30W	30W	30W	30.24W	30.24W	30.24W
	RIPPLE & NOISE (max.) Note.2	2.6Vp-p	2Vp-p	2.6Vp-p	2.6Vp-p	2.6Vp-p	2.3Vp-p	4.5Vp-p	3.7Vp-p
	VOLTAGE ADJ. RANGE Note.5	-5% ~ 10%. Can be adjusted by internal potentiometer SVR1							
	CURRENT ADJ. RANGE Note.5	3% ~ -25%. Can be adjusted by internal potentiometer SVR2							
	VOLTAGE TOLERANCE Note.3	±10%							
	LINE REGULATION	±3.0%							
LOAD REGULATION	±5.0%								
SETUP TIME	1500ms / 230VAC 3000ms / 115VAC at full load								
INPUT	VOLTAGE RANGE Note.4	90 ~ 295VAC		127 ~ 417VDC					
	FREQUENCY RANGE	47 ~ 63Hz							
	POWER FACTOR (Typ.)	PF>0.95/115VAC, PF>0.9/230VAC, PF>0.9/277VAC at full load (Please refer to "Power Factor Characteristic" curve)							
	EFFICIENCY (Typ.)	80%	82.5%	83.5%	84%	84%	84.5%	85%	85.5%
	AC CURRENT (Typ.)	0.4A/115VAC		0.2A/230VAC					
	INRUSH CURRENT (max.)	40A/230VAC							
	LEAKAGE CURRENT	<0.5mA / 240VAC							
PROTECTION	OVER CURRENT	100 ~ 110%							
	SHORT CIRCUIT	Protection type : Constant current limiting, recovers automatically after fault condition is removed							
	OVER VOLTAGE	10 ~ 14V	14 ~ 16V	17 ~ 22V	23 ~ 26V	27 ~ 34V	31 ~ 35V	40 ~ 50V	53 ~ 63V
	OVER TEMPERATURE	95°C ±10°C (TSW1)							
ENVIRONMENT	WORKING TEMP.	-30 ~ +50°C (Refer to "Derating Curve")							
	WORKING HUMIDITY	20 ~ 95% RH non-condensing							
	STORAGE TEMP., HUMIDITY	-40 ~ +80°C, 10 ~ 95% RH							
	TEMP. COEFFICIENT	±0.06%/°C (0 ~ 50°C)							
	VIBRATION	10 ~ 500Hz, 2G 12min./1cycle, period for 72min. each along X, Y, Z axes							
SAFETY & EMC	SAFETY STANDARDS	UL879, TUV EN61347-1, EN61347-2-13, CAN/CSA C22.2 No. 223-M91(except for 48V) ; J61347-1, J61347-2-13, IP64 approved							
	WITHSTAND VOLTAGE	I/P-O/P:3.75KVAC							
	ISOLATION RESISTANCE	I/P-O/P:100M Ohms / 500VDC / 25°C / 70% RH							
	EMC EMISSION	Compliance to EN55015, EN61000-3-2 Class C (pin ≥ 25W), Class D (>70% load) ; EN61000-3-3							
OTHERS	EMC IMMUNITY	Compliance to EN61000-4-2,3,4,5,6,8,11, EN55024, EN61547, light industry level, criteria A							
	MTBF	621.4Khrs min. MIL-HDBK-217F (25°C)							
	DIMENSION	145*47*30mm (L*W*H)							
NOTE	PACKING	0.22Kg; 60pcs/14.2Kg/1.25CUFT							
		<ol style="list-style-type: none"> <li>All parameters NOT specially mentioned are measured at 230VAC input, rated load and 25°C of ambient temperature.</li> <li>Ripple &amp; noise are measured at 20MHz of bandwidth by using a 12" twisted pair-wire terminated with a 0.1µf &amp; 47µf parallel capacitor.</li> <li>Tolerance : includes set up tolerance, line regulation and load regulation.</li> <li>Derating may be needed under low input voltage. Please check the static characteristics for more details.</li> <li>Output voltage can be adjusted through the SVR1 on the PCB; limit of output constant current level can be adjusted through the SVR2 on the PCB.</li> <li>Constant current operation region is within 70% ~100% rated output voltage. This is the suitable operation region for LED related applications, but please reconfirm special electrical requirements for some specific system design.</li> <li>The power supply is considered as a component that will be operated in combination with final equipment. Since EMC performance will be affected by the complete installation, the final equipment manufacturers must re-qualify EMC Directive on the complete installation again.</li> <li>Direct connecting to LEDs is suggested, but is not suitable for using additional drivers.</li> </ol>							

## Mechanical Specification

Case No.964A Unit:mm

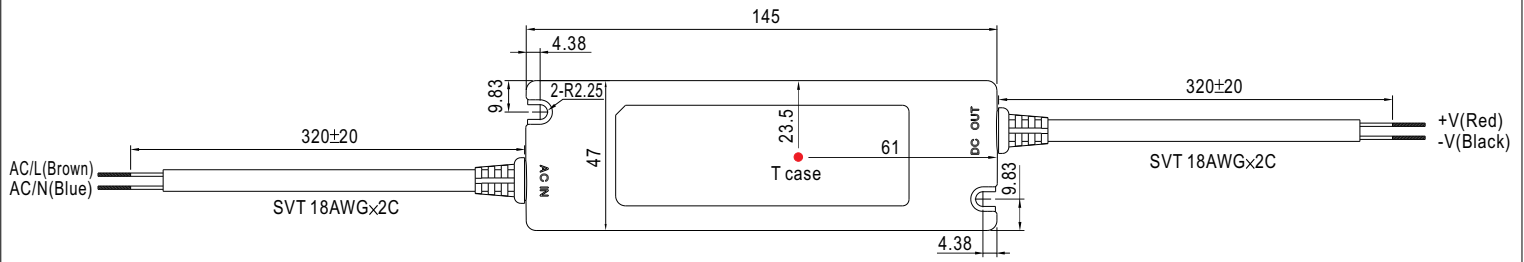

※ T case: Max. Case Temperature.

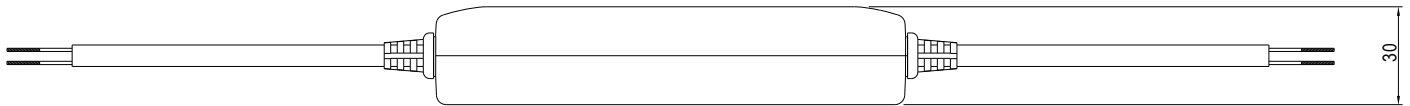

Output voltage and current adjustment : remove the upper case and adjust through SVR1 & SVR2 shown in the diagram.

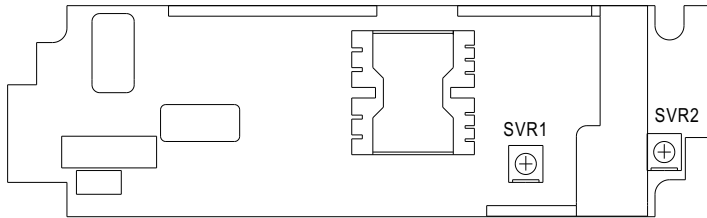

SVR1	Output voltage adjustment
SVR2	Output current adjustment

## Block Diagram

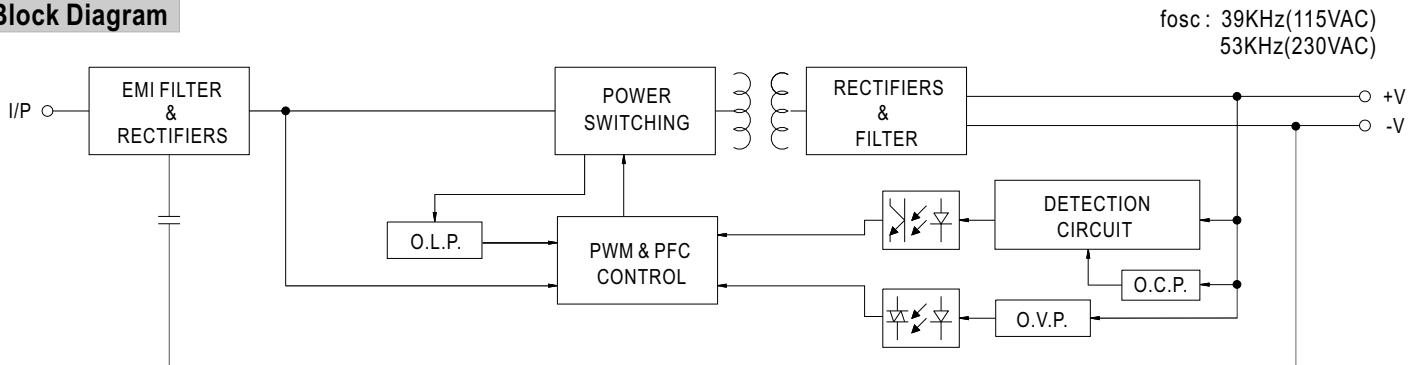

## Derating Curve

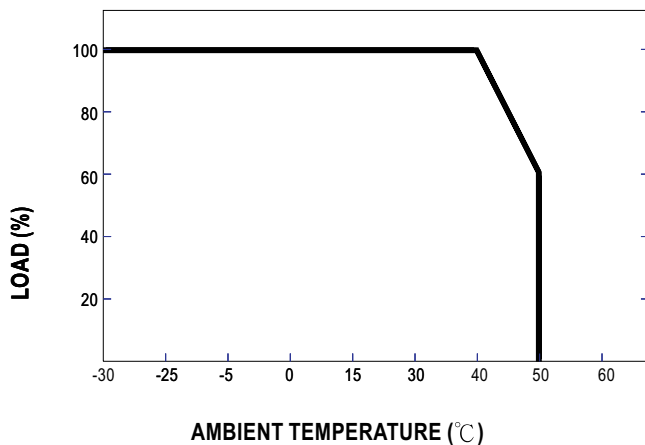

## Static Characteristics

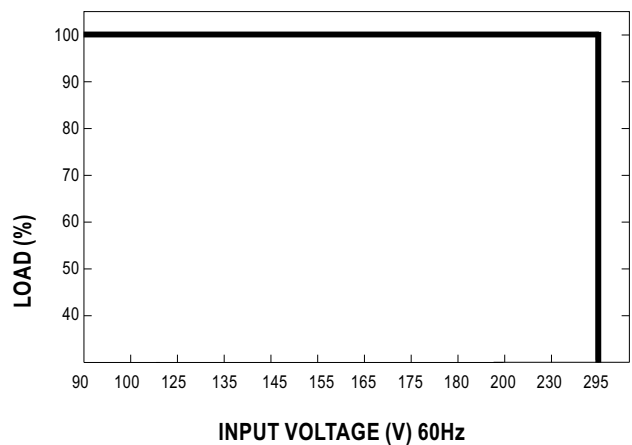

**Power Factor Characteristic**

**Constant Current Mode**

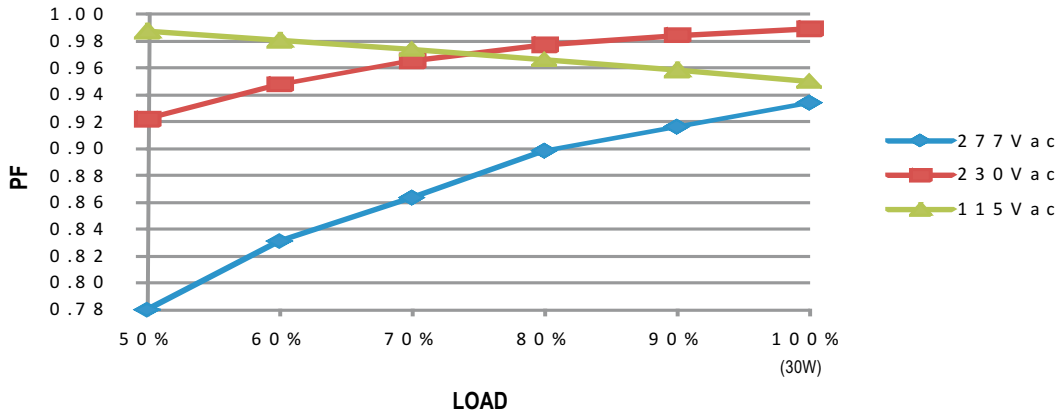

**EFFICIENCY vs LOAD (48V Model)**

PLN-30 series possess superior working efficiency that up to 85.5% can be reached in field applications.

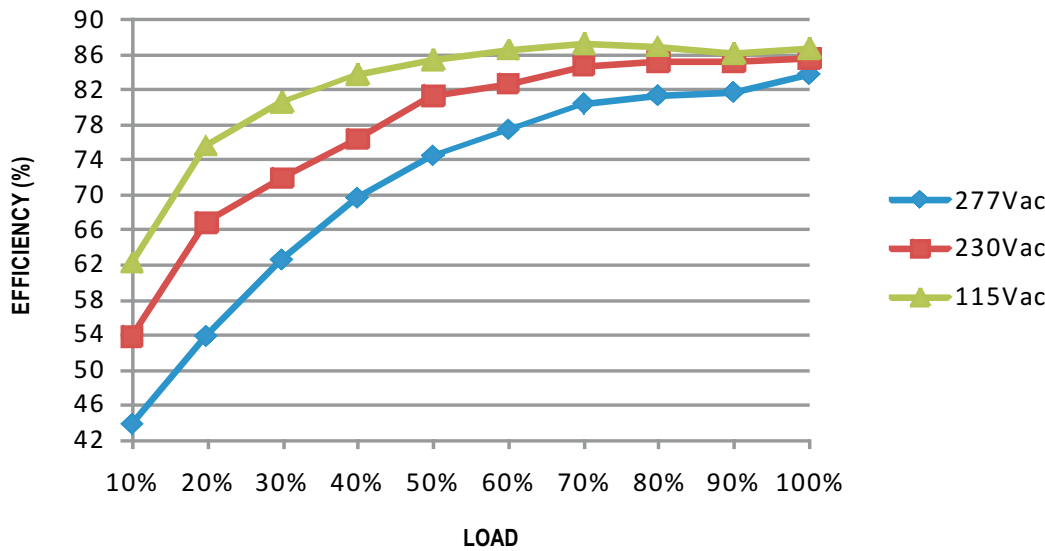

**DRIVING METHODS OF LED MODULE**

This LED power supply is suggested to work in constant current mode area (CC) to drive the LEDs.

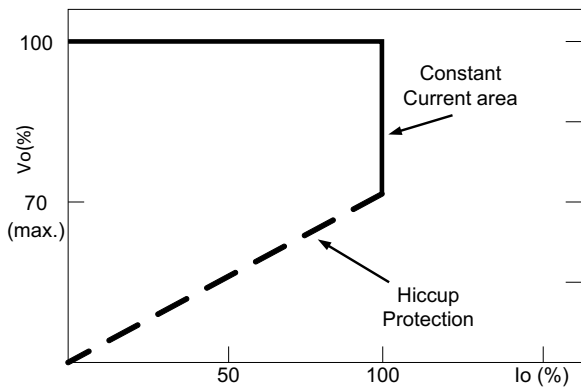

Typical LED power supply I-V curve