

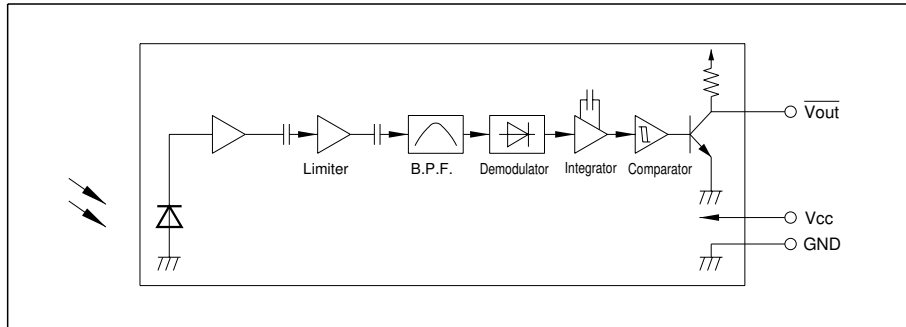


## Model Line-ups

Diversified models with a different B.P.F. frequency are also available.

B.P.F. center frequency	Model No.				Unit
40	GP1U26X	GP1U27X	GP1U28X	GP1U28Y	kHz
36	GP1U260X	GP1U270X	GP1U280X	GP1U280Y	
38	GP1U261X	GP1U271X	GP1U281X	GP1U281Y	
36.7	GP1U262X	GP1U272X	GP1U282X	GP1U282Y	
32.75	GP1U263X	GP1U273X	GP1U283X	GP1U283Y	
56.8	GP1U267X	GP1U277X	GP1U287X	GP1U287Y	

## Internal Block Diagram



## Absolute Maximum Ratings (Ta=25°C)

Parameter	Symbol	Rating	Unit
Supply voltage	V <sub>CC</sub>	0 to 6.3	V
*1 Operating temperature	T <sub>opr</sub>	- 10 to + 70	°C
Storage temperature	T <sub>stg</sub>	- 20 to + 70	°C
*2 Soldering temperature	T <sub>sol</sub>	260	°C

\*1 No dew condensation is allowed.

\*2 For 5 seconds

## Recommended Operating Conditions

Parameter	Symbol	Operating conditions	Unit
Supply voltage	V <sub>CC</sub>	4.7 to 5.3	V

## Electrical Characteristics

(Ta=25°C, V<sub>CC</sub> =+5V)

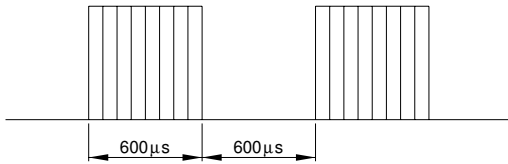
Parameter	Symbol	Conditions	MIN.	TYP.	MAX.	Unit
Dissipation current	I <sub>CC</sub>	No input light	-	-	5.0	mA
High level output voltage	V <sub>OH</sub>	*3	V <sub>CC</sub> - 0.5	-	-	V
Low level output voltage	V <sub>OL</sub>		-	-	0.45	V
High level pulse width	T <sub>1</sub>		400	-	800	μs
Low level pulse width	T <sub>2</sub>		400	-	800	
B.P.F. center frequency	f <sub>0</sub>	-	-	*4	-	kHz

\*3 The burst wave as shown in the following figure shall be transmitted by the transmitter shown in Fig. 1.

The carrier frequency of the transmitter, however, shall be same as \*4, and measurement shall be taken of the 100th and subsequent pulses after start of transmission.

\*4 The B.P.F. center frequency f<sub>0</sub> varies with model, as shown in ■ **Model Line-ups**.

Burst wave



$$f_0 = *4 \text{ kHz} \quad \text{Duty } 50\%$$

## Performance

Using the transmitter shown in Fig. 1, the output signal of the light detecting unit is good enough to meet the following items in the standard optical system in Fig. 2.

### (1) Linear reception distance characteristics

When L=0.2 to 8 m, E<sub>e</sub>\*5 < 10 lx and φ = 0° in Fig. 2, the output signal shall meet the electrical characteristics in the attached list.

### (2) Sensitivity angle reception distance characteristics

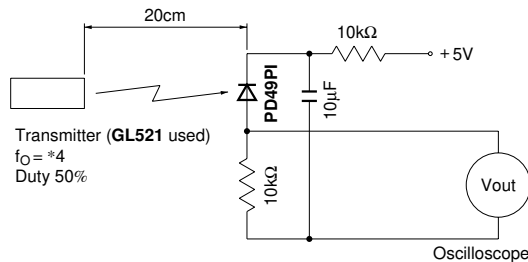
When L=0.2 to 6 m, E<sub>e</sub>\*5 < 10 lx and φ <= 30° in Fig. 2, the output signal shall meet the electrical characteristics in the attached list.

### (3) Anti outer peripheral light reception distance characteristics

When L=0.2 to 4 m, E<sub>e</sub>\*6 <= 300 lx and φ = 0° in Fig. 2, the output signal shall meet the electrical characteristics in the attached list.

\*5 It refers to detector face illuminance.

\*6 Outer peripheral light source: CIE standard light source A shall be used and placed at 45° from perpendicular axis at the detector face center.

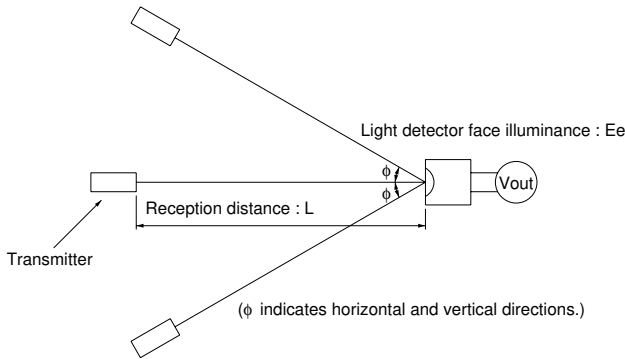


In the above figure, the transmitter should be set so that the output V<sub>out</sub> can be 40mV<sub>P-P</sub>.

However, the PD49PI to be used here should be of the short-circuit current I<sub>SC</sub>=2.6 μA at E<sub>V</sub>=100 lx.

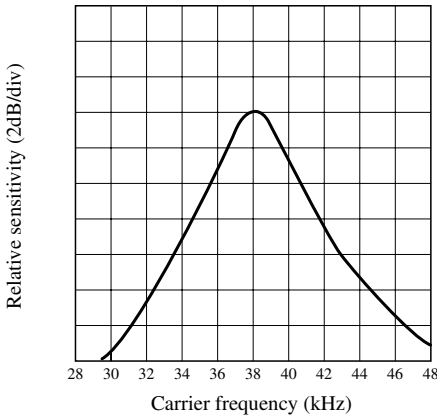
(E<sub>V</sub> is an illuminance by CIE standard light source A (tungsten lamp).)

**Fig. 1 Transmitter**

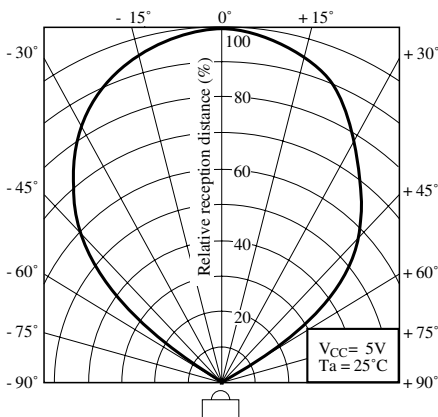


**Fig. 2 Standard optical system**

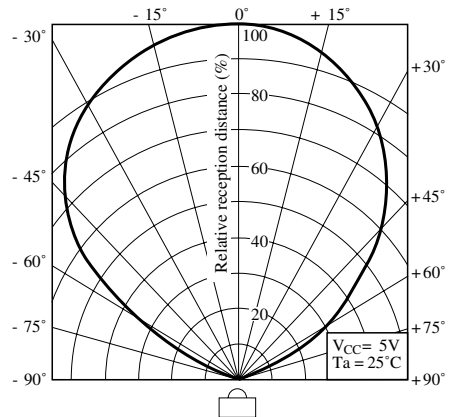
**Fig. 1 B.P.F. Frequency Characteristics [TYP.](GP1Uxx1X)**



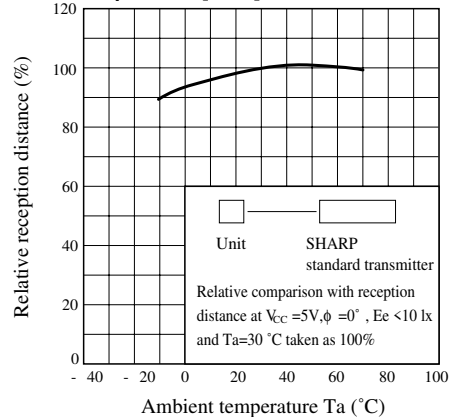
**Fig. 3 Sensitivity Angle (Vertical Direction) Characteristics [TYP.] for Reference**



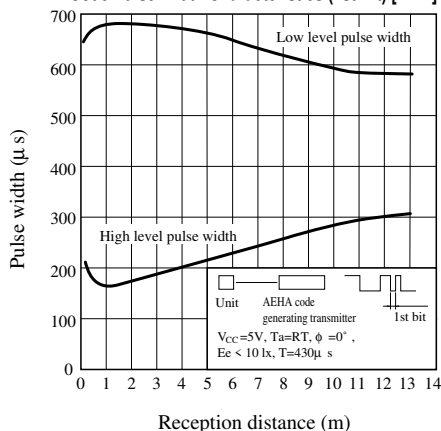
**Fig. 2 Sensitivity Angle (Horizontal Direction) Characteristics [TYP.] for Reference**



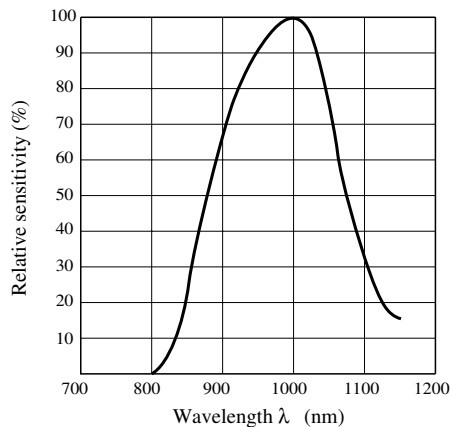
**Fig. 4 Relative Reception Distance vs. Ambient Temperature [TYP.] for Reference**



**Fig. 5 AEHA (Japan Association of Electrical Home Appliances)  
Code Pulse Width Characteristics (1st Bit) [TYP.] for Reference**



**Fig. 6 Spectral Sensitivity for Reference**



## ■ Precautions for Operation

- In case of adopting the infrared light detecting unit for the wireless remote control, use it in accordance with the transmission scheme and the signal format recommended in "Countermeasures for malfunction prevention of home appliances with remote control" issued from Japan Association of Electrical Home Appliances (AEHA) in July, 1987. Use of a transmission scheme and a signal format different from those recommended may cause malfunction of home appliances. (Example : signal format without leader signal, bit structure of small duty ratio ( $T_H/(T_H+T_L)$ ))
- Use the light emitting unit (remote control transmitter), in consideration of performance, characteristics, operating conditions of light emitting device and the characteristics of the light detecting unit.
- Pay attention to a malfunction of the light detecting unit when the surface is stained with dust and refuse. Care must be taken not to touch the light detector surface. If it should be dirty, wipe off such dust and refuse with soft cloth so as to prevent scratch. In case some solvents are required, use methyl alcohol, ethyl alcohol or isopropyl alcohol only. Also, protect the light detecting unit against flux and others, since their deposition on the unit inside causes reduction of the function, fading of markings such as the part number.
- The shield case should be grounded on PWB pattern. (The area across the shield case and the GND terminal is internally conductive in some cases and non-conductive in some other cases.)
- Do not apply unnecessary force to the terminal and the case.
- Do not push the light detector surface (photodiode) from outside.
- To avoid the electrostatic breakdown of IC, handle the unit under the condition of grounding with human body, soldering iron, etc.
- Do not use hole and groove set in the case of the light detecting unit for other purposes, since they are required to maintain the specified performance.