

1 2 3 4 5 6 7 8 9 10 11 12 13 14

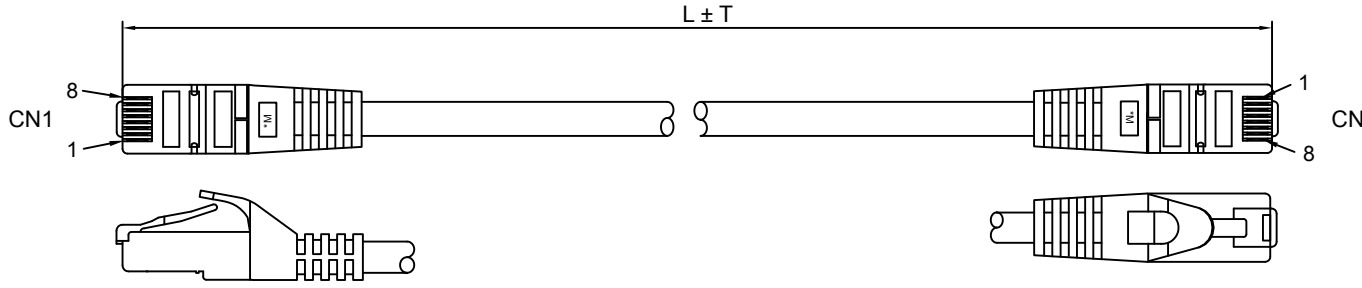

Spezifikation / Specification	CAT 6
Kabeltyp / Cable type	CAT 7 Rohkabel / round cable
Innenleiter, Material / Inner conductor material	CU (Kupfer) / CU (copper)
Innenleiter, Aderdurchmesser / Inner conductor, core diameter	(7/0.15 ± 0.005 mm)
AWG	26/7 (stranded)
Schirmungsklasse / Shielding class	S/FTP (PiMF)
Anzahl Schirmungen / Number of shieldings	2 x
Typ 1, Schirmung / Type 1, shielding	Folie (Alu) PiMF / foil (alu) PiMF
Typ 2, Schirmung / Type 2, shielding	Geflecht (Alu) Gesamtschirm / braid (alu) overall shield
Durchmesser Kabelmantel (ca.) / Cable sheath diameter (approx.)	Ø 6.2 ± 0.2 mm, LSZH
Knickschutz / Kink protection	beidseitig / both sides
LSZH-konform / LSZH compliant	ja / yes
Anschluss, Typ / Connection, type	RJ45-Stecker (8P8C) / RJ45 male (8P8C)
Anschluss, Schirmung / Connection, shielding	ja / yes
Anschluss 2, Typ / Connection 2, type	RJ45-Stecker (8P8C) / RJ45 male (8P8C)
Rastnasenschutz / Latch protection	beidseitig / both sides
max. Bandbreite / max. bandwidth	500 MHz

**PIN OUT**

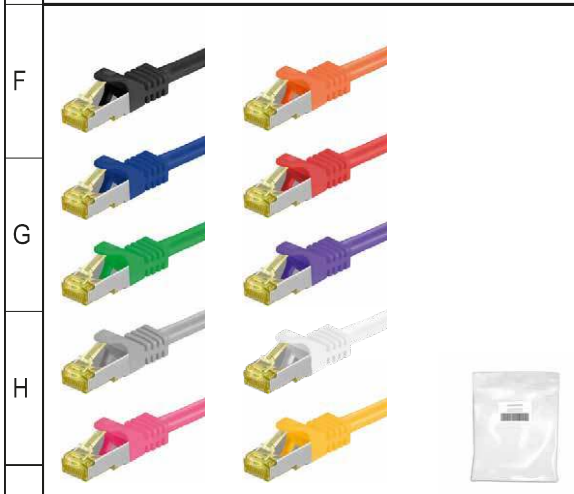
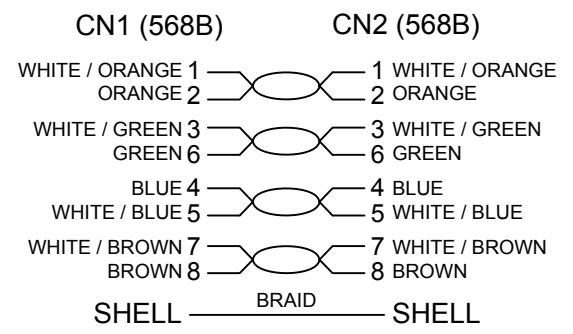

**RJ45 Patchkabel CAT 6A S/FTP (PiMF) mit CAT 7 Rohkabel**

- doppelt geschirmtes LAN/Netzwerkkabel zum Anschluss ihrer Netzwerkkomponenten mit 2x RJ45 (CAT 6A, 500 MHz) Steckern
- Cat 7 Rohkabel bis 600 MHz
- mit 50µ vergoldeten Kontaktflächen (PINs)
- Aderpaarschirmung: PiMF (Paare in Metall Folie) + Gesamtschirmung: Geflecht
- Längenangabe auf Slimline-Knickschutztülle
- mit Rastnasenschutz
- geeignet für Power over Ethernet (PoE/PoE+)
- Betriebstemperatur: -20 °C bis 65 °C

**RJ45 patch cord CAT 6A S/FTP (PiMF), with CAT 7 raw cable**

- LAN / network cable to connect network components with 2 x RJ45 (CAT 6A, 500 MHz) connectors
- Cat 7 raw cable up to 600 MHz
- with 50µ gold plated PINs
- pairs screening: PiMF (pairs in metal foil) + outer shield: braiding
- with length indication on the slimline strain relief
- with latch protection
- suitable for Power over Ethernet (PoE/PoE+)
- Operating temperature: -20 °C up to 65 °C

<b>Änderungen</b>		Datum	Name	Bezeichnung	Blatt
Datum	Name	gez.:	01.09.2020	sm	1 / 2
		gepr.:	01.09.2020	ac	
		Norm:		Zeichnungs-Nr.:	von
Änderungen vorbehalten / Subject to change				CAT 7-xxxx S/FTP PIMF RJ45 LSZH x.xx m	





1 2 3 4 5 6 7 8 9 10 11 12 13 14



1 2 3 4 5 6 7 8 9 10 11 12 13 14



A  
B  
C  
D  
E  
F  
G  
H

A  
B  
C  
D  
E  
F  
G  
H

Farbe / Colour	Art.	L [m]
schwarz / black 	91572	0.25
	91581	0.50
	91590	1.00
	91599	1.50
	91608	2.00
	91617	3.00
	91626	5.00
	91635	7.50
	91644	10.00
	91653	15.00
91662	20.00	
91671	25.00	
91680	30.00	
blau / blue 	91565	0.25
	91574	0.50
	91583	1.00
	91592	1.50
	91601	2.00
	91610	3.00
	91619	5.00
	91628	7.50
	91637	10.00
	91646	15.00
91655	20.00	
91664	25.00	
91673	30.00	

Farbe / Colour	Art.	L [m]
grün / green 	91568	0.25
	91577	0.50
	91586	1.00
	91595	1.50
	91604	2.00
	91613	3.00
	91622	5.00
	91631	7.50
	91640	10.00
	91649	15.00
91658	20.00	
91667	25.00	
91676	30.00	
grau / grey 	91567	0.25
	91576	0.50
	91585	1.00
	91594	1.50
	91603	2.00
	91612	3.00
	91621	5.00
	91630	7.50
	91639	10.00
	91648	15.00
91657	20.00	
91666	25.00	
91675	30.00	

Farbe / Colour	Art.	L [m]
magenta / magenta 	91569	0.25
	91578	0.50
	91587	1.00
	91596	1.50
	91605	2.00
	91614	3.00
	91623	5.00
	91632	7.50
	91641	10.00
	91650	15.00
91659	20.00	
91668	25.00	
91677	30.00	
orange / orange 	91570	0.25
	91579	0.50
	91588	1.00
	91597	1.50
	91606	2.00
	91615	3.00
	91624	5.00
	91633	7.50
	91642	10.00
	91651	15.00
91660	20.00	
91669	25.00	
91678	30.00	

Farbe / Colour	Art.	L [m]
rot / red 	91571	0.25
	91580	0.50
	91589	1.00
	91598	1.50
	91607	2.00
	91616	3.00
	91625	5.00
	91634	7.50
	91643	10.00
	91652	15.00
91661	20.00	
91670	25.00	
91679	30.00	
violett / violett 	91573	0.25
	91582	0.50
	91591	1.00
	91600	1.50
	91609	2.00
	91618	3.00
	91627	5.00
	91636	7.50
	91645	10.00
	91654	15.00
91663	20.00	
91672	25.00	
91681	30.00	

Farbe / Colour	Art.	L [m]
weiß / white 	91089	0.25
	91090	0.50
	91091	1.00
	91092	1.50
	91093	2.00
	91094	3.00
	91095	5.00
	91096	7.50
	91097	10.00
	91098	15.00
91099	20.00	
91100	25.00	
91101	30.00	
gelb / yellow 	91566	0.25
	91575	0.50
	91584	1.00
	91593	1.50
	91602	2.00
	91611	3.00
	91620	5.00
	91629	7.50
	91638	10.00
	91647	15.00
91656	20.00	
91665	25.00	
91674	30.00	

Änderungen		Datum	Name	Bezeichnung	Blatt
Datum	Name	gez.: 01.09.2020	sm	CAT 7-xxxx S/FTP PIMF RJ45 LSZH x.xx m	2 / 2
		gepr.: 01.09.2020	ac		
		Norm:		Zeichnungs-Nr.:	von
Änderungen vorbehalten / Subject to change				91089ff	



1 2 3 4 5 6 7 8 9 10 11 12 13 14