

# ROYALOHM

**C O N F I D E N T I A L   D O C U M E N T**

SPECIFICATION FOR APPROVAL

Description : Thick Film Chip Resistors (Terminal Lead Free)

**Royalohm Part no.:**

0201WMxxxxxTEE	(RMC (0201)	1/20W	+/- 1%, 5%)
0402WGxxxxxTCE	(RMC (0402)	1/16W	+/- 1%, 5%)
0603WAxxxxxT5E	(RMC (0603)	1/10W	+/- 1%, 5%)
0805W8xxxxxT5E	(RMC (0805)	1/8W	+/- 1%, 5%)
1206W4xxxxxT5E	(RMC (1206)	1/4W	+/- 1%, 5%)
1210W2xxxxxT5E	(RMC (1210)	1/2W	+/- 1%, 5%)
181207xxxxxT4E	(RMC (1812)	3/4W	+/- 1%, 5%)
201007xxxxxT4E	(RMC (2010)	3/4W	+/- 1%, 5%)
25121WxxxxxT4E	(RMC (2512)	1W	+/- 1%, 5%)

Approved by

**RoHS V3 Compliant (EU) 2015/863**

**REACH Compliant**

Royal Electronic Factory (Thailand) Co., Ltd.

20/1-2 Moo 2 Klong-Na, Muang

Chachoengsao 24000, Thailand

Tel: +66-38-822404-8

Fax: +66 38-981190 / 823765

E-mail Address: Export sales: [Export@royalohm.com](mailto:Export@royalohm.com)

Local sales: [Local@royalohm.com](mailto:Local@royalohm.com)

[http:// www.royalohm.com](http://www.royalohm.com)

Approved	Checked	Prepared
Mr. XP Hong	Mr. S. Polthanasan	Mr. N. Suphawut

Issue Date: 2019/07/31



**Thick Film Chip Resistors (Terminal Lead Free)**

1. Scope:

This specification for approval relates to Thick Film Chip Resistors (Terminal Lead Free) manufactured by ROYALOHM 's specifications.

2. Type designation:

The type designation shall be in the following form:

Type	Power Rating	Resistance tolerance	Nominal Resistance
Ex. RMC 0603	1/10W	F,J	75Ω

3. Ratings:

Type	0201	0402	0603	0805	1206	1210	1812	2010	2512
Power Rating	1/20W	1/16W	1/10W	1/8W	1/4W	1/2W	3/4W	3/4W	1W
Max. Working Voltage	25 V	50 V	75 V	150 V	200 V	200 V	200 V	200 V	200 V
Max. Overload Voltage	50 V	100 V	150 V	300 V	400 V	500 V	500 V	500 V	500 V
Dielectric Withstanding Voltage	-	100 V	300 V	500 V	500 V	500 V	500 V	500 V	500 V
Temperature Range	-55°C ~ +155°C								
Ambient Temperature	70 °C								

3.1 Power rating:

Resistors shall have a power rating based on continuous load operation at an ambient temperature of 70 °C . For temperature in excess of 70 °C , The load shall be derate as shown in figure 1.

Figure 1

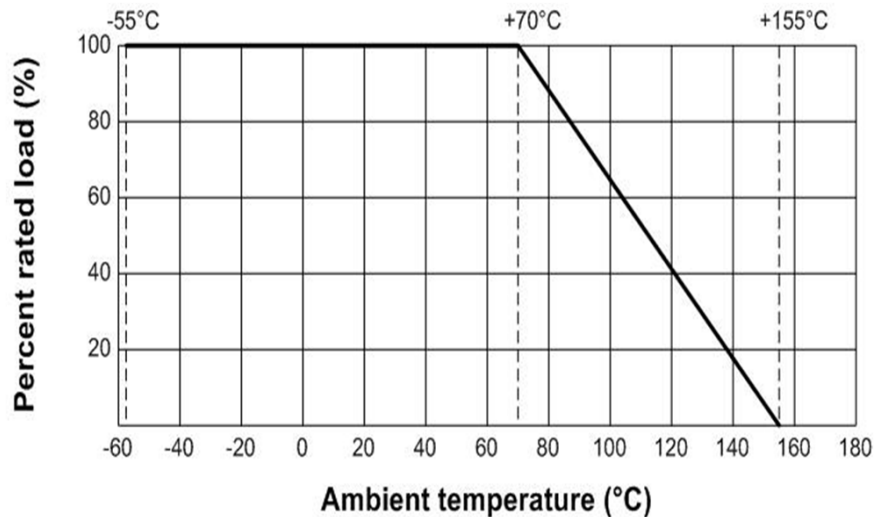

3.2 Nominal Resistance

Effective figures of nominal resistance shall be in accordance :

- E-24 and E-96 series for 1 %
- E-24 series for 2 % and 5 %

### Thick Film Chip Resistors (Terminal Lead Free)

4. Construction :

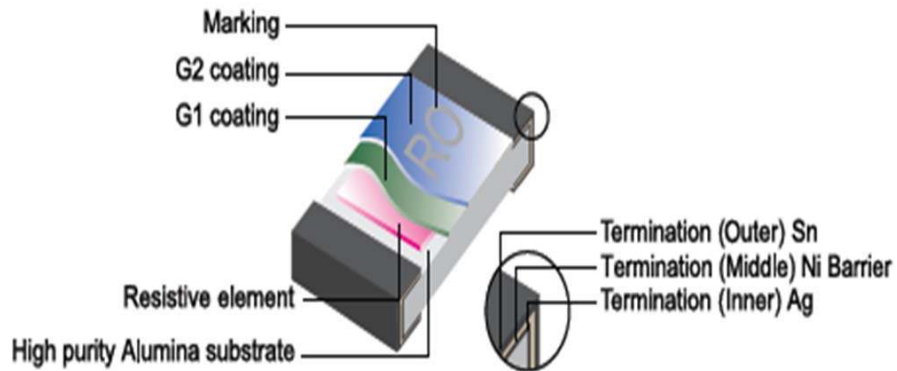

5. Power rating and dimensions

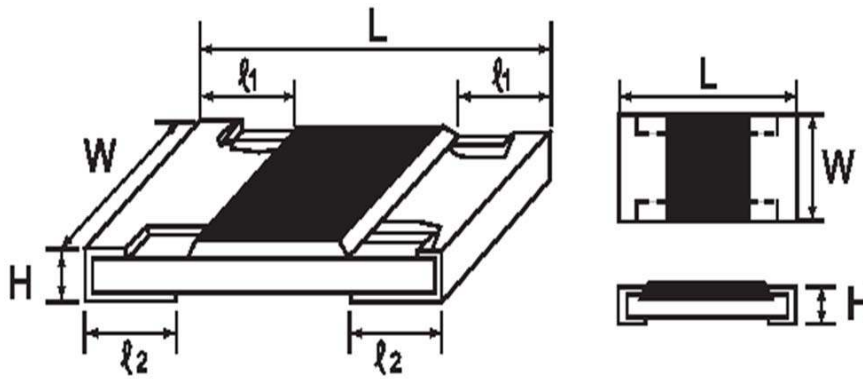

Dimension :

Type	Dimension (mm)				
	L	W	H	ℓ1	ℓ2
RMC 0201	0.60 ± 0.03	0.30 ± 0.03	0.23 ± 0.03	0.10 ± 0.05	0.15 ± 0.05
RMC 0402	1.00 ± 0.10	0.50 ± 0.05	0.35 ± 0.05	0.20 ± 0.10	0.25 ± 0.10
RMC 0603	1.60 ± 0.10	0.80 + 0.15 - 0.10	0.45 ± 0.10	0.30 ± 0.20	0.30 ± 0.20
RMC 0805	2.00 ± 0.15	1.25 + 0.15 - 0.10	0.55 ± 0.10	0.40 ± 0.20	0.40 ± 0.20
RMC 1206	3.10 ± 0.15	1.55 + 0.15 - 0.10	0.55 ± 0.10	0.45 ± 0.20	0.45 ± 0.20
RMC 1210	3.10 ± 0.10	2.60 ± 0.20	0.55 ± 0.10	0.50 ± 0.25	0.50 ± 0.20
RMC 1812	4.50 ± 0.20	3.20 ± 0.20	0.55 ± 0.20	0.50 ± 0.20	0.50 ± 0.20
RMC 2010	5.00 ± 0.10	2.50 ± 0.20	0.55 ± 0.10	0.60 ± 0.25	0.50 ± 0.20
RMC 2512	6.35 ± 0.10	3.20 ± 0.20	0.55 ± 0.10	0.60 ± 0.25	0.50 ± 0.20

**Thick Film Chip Resistors (Terminal Lead Free)**

Power Rating :

Type	Power Rating at 70 °C	Tolerance %	Resistance Range	TCR PPM/°C	Standard Series
RMC 0201	1/20W	± 1 ,± 5	$1\Omega \leq R \leq 10\Omega$	-100~+350	E-96, E-24
			$> 10\Omega$	±200	
RMC 0402	1/16W	± 1 ,± 5	$1\Omega \leq R \leq 10\Omega$	±200	E-96, E-24
			$> 10\Omega$	±100	
RMC 0603	1/10W	± 1 ,± 5	$0.01\Omega \leq R \leq 0.03\Omega$	±1500	E-96, E-24
			$0.03\Omega < R \leq 0.05\Omega$	±1000	
			$0.05\Omega < R < 1\Omega$	±800	
			$1\Omega \leq R \leq 10\Omega$	±200	
			$> 10 \Omega$	±100	
RMC 0805	1/8W	± 1 ,± 5	$0.01\Omega \leq R \leq 0.015\Omega$	±1500	E-96, E-24
			$0.015\Omega < R \leq 0.03\Omega$	±1000	
			$0.03\Omega < R < 1\Omega$	±800	
			$1\Omega \leq R \leq 10\Omega$	±200	
			$> 10 \Omega$	±100	
RMC 1206	1/4W	± 1 ,± 5	$0.01\Omega \leq R \leq 0.015\Omega$	±1500	E-96, E-24
			$0.015\Omega < R \leq 0.03\Omega$	±1000	
			$0.03\Omega < R < 1\Omega$	±800	
			$1\Omega \leq R \leq 10\Omega$	±200	
			$> 10 \Omega$	±100	
RMC 1210	1/2W	± 1 ,± 5	$0.01\Omega \leq R \leq 0.015\Omega$	±1500	E-96, E-24
			$0.015\Omega < R \leq 0.03\Omega$	±1000	
			$0.03\Omega < R < 1\Omega$	±800	
			$1\Omega \leq R \leq 10\Omega$	±200	
			$> 10 \Omega$	±100	
RMC 1812	3/4W	± 1 ,± 5	$0.01\Omega \leq R \leq 0.015\Omega$	±1500	E-96, E-24
			$0.015\Omega < R \leq 0.03\Omega$	±1000	
			$0.03\Omega < R < 1\Omega$	±800	
			$1\Omega \leq R \leq 10\Omega$	±200	
			$> 10 \Omega$	±100	
RMC 2010	3/4W	± 1 ,± 5	$0.01\Omega \leq R \leq 0.015\Omega$	±1500	E-96, E-24
			$0.015\Omega < R \leq 0.03\Omega$	±1000	
			$0.03\Omega < R < 1\Omega$	±800	
			$1\Omega \leq R \leq 10\Omega$	±200	
			$> 10 \Omega$	±100	
RMC 2512	1W	± 1 ,± 5	$0.01\Omega \leq R \leq 0.015\Omega$	±1500	E-96, E-24
			$0.015\Omega < R \leq 0.03\Omega$	±1000	
			$0.03\Omega < R < 1\Omega$	±800	
			$1\Omega \leq R \leq 10\Omega$	±200	
			$> 10 \Omega$	±100	

## Thick Film Chip Resistors (Terminal Lead Free)

### Mutiplier Code :

Code	A	B	C	D	E	F	G	H	X	Y	Z
<b>Multiplier</b>	0 10	1 10	2 10	3 10	4 10	5 10	6 10	7 10	-1 10	-2 10	-3 10

<b>Coding</b>	<b>Formula</b>	<b>Example :</b>
<u>XX</u>	<u>X</u>	$10.2K\Omega = \begin{matrix} 102 \\ \downarrow \\ 02 \end{matrix} \times \begin{matrix} 10^2 \\ \downarrow \\ C \end{matrix} \Omega = 02C$
		$33.2\Omega = \begin{matrix} 332 \\ \downarrow \\ 51 \end{matrix} \times \begin{matrix} 10^{-1} \\ \downarrow \\ X \end{matrix} \Omega = 51X$
Resistance Code	Multiplier Code	

Value	Code	Value	Code	Value	Code	Value	Code	Value	Code
100	<b>01</b>	162	<b>21</b>	261	<b>41</b>	422	<b>61</b>	681	<b>81</b>
102	<b>02</b>	165	<b>22</b>	267	<b>42</b>	432	<b>62</b>	698	<b>82</b>
105	<b>03</b>	169	<b>23</b>	274	<b>43</b>	442	<b>63</b>	715	<b>83</b>
107	<b>04</b>	174	<b>24</b>	280	<b>44</b>	453	<b>64</b>	732	<b>84</b>
110	<b>05</b>	178	<b>25</b>	287	<b>45</b>	464	<b>65</b>	750	<b>85</b>
113	<b>06</b>	182	<b>26</b>	294	<b>46</b>	475	<b>66</b>	768	<b>86</b>
115	<b>07</b>	187	<b>27</b>	301	<b>47</b>	487	<b>67</b>	787	<b>87</b>
118	<b>08</b>	191	<b>28</b>	309	<b>48</b>	499	<b>68</b>	806	<b>88</b>
121	<b>09</b>	196	<b>29</b>	316	<b>49</b>	511	<b>69</b>	825	<b>89</b>
124	<b>10</b>	200	<b>30</b>	324	<b>50</b>	523	<b>70</b>	845	<b>90</b>
127	<b>11</b>	205	<b>31</b>	332	<b>51</b>	536	<b>71</b>	866	<b>91</b>
130	<b>12</b>	210	<b>32</b>	340	<b>52</b>	549	<b>72</b>	887	<b>92</b>
133	<b>13</b>	215	<b>33</b>	348	<b>53</b>	562	<b>73</b>	909	<b>93</b>
137	<b>14</b>	221	<b>34</b>	357	<b>54</b>	576	<b>74</b>	931	<b>94</b>
140	<b>15</b>	226	<b>35</b>	365	<b>55</b>	590	<b>75</b>	953	<b>95</b>
143	<b>16</b>	232	<b>36</b>	374	<b>56</b>	604	<b>76</b>	976	<b>96</b>
147	<b>17</b>	237	<b>37</b>	383	<b>57</b>	619	<b>77</b>		
150	<b>18</b>	243	<b>38</b>	392	<b>58</b>	634	<b>78</b>		
154	<b>19</b>	249	<b>39</b>	402	<b>59</b>	649	<b>79</b>		
158	<b>20</b>	255	<b>40</b>	412	<b>60</b>	665	<b>80</b>		

\*Marking for 0603 E-96 series, the resistance value that no have multiplier code indicate marking follow this:  
 The first two digits are significant figures of resistance and the third one denoted number of zeros  
 and under line the marking letters.

Ex. 

	<u>122</u>	
--	------------	--

 1.2KΩ

**Thick Film Chip Resistors (Terminal Lead Free)**

**6. Marking :**

**6.1 Resistors**

A.  $\pm 5\%$  Tolerance 0603, 0805, 1206, 1210, 1812, 2010, 2512: the first two digits are significant figures of resistance and the third denoted number of zeros.

Ex.		333		33K $\Omega$
-----	--	-----	--	--------------

B. For ohmic values below 10  $\Omega$

Ex.		2R2		2.2 $\Omega$
-----	--	-----	--	--------------

C. For E-96 series [ $\pm 1\%$  (F) tolerance] in 0603 size 3 digit system (due to space restrictions) please refer to page 4 for coding formula

Ex.		02C		10.2K $\Omega$
-----	--	-----	--	----------------

D.  $\pm 1\%$  Tolerance 0805, 1206, 1210, 1812, 2010, 2512 : 4 Digits, the first three digits are significant figures of resistance and the fourth digit denoted number of zeros. Letter "R" is for decimal point.

Ex.		2701		2.7K $\Omega$
-----	--	------	--	---------------

E. Chip Resistors type 0402 No marking

F. Marking for  $\pm 1\%$ ,  $\pm 5\%$  Tolerance 0805, 1206, 1210, 1812, 2010, 2512 (Only for 0.01 $\Omega$  ~ 0.099 $\Omega$ ) : 4 Digits

Ex.		R091		0.091 $\Omega$
-----	--	------	--	----------------

Ex.		R010		0.01 $\Omega$
-----	--	------	--	---------------

**6.2 Labels**

Label shall be marked with the following item :

A. Nominal Resistance and Resistance Tolerance

B. Power Rating and Size

C. Quantity

D. Part No.

E. P.O.No.

F. Lot No.

Ex.

<b>ROYALOHM</b>			
<b>CHIP RESISTOR</b>			
RESISTANCE:	75	$\Omega$	$\pm 1\%$
WATTAGE:	1/10W	SIZE:	0603
QUANTITY:	5,000	PCS	Pb-Free
PART NO.:			
P.O.NO.:			
LOT NO. :	825723	0603WAF750JT5E	
			

Remark : For **0603**  $\pm 1\%$  : Label is 75R, value is 75 $\Omega$ , marking is 85X

**Thick Film Chip Resistors (Terminal Lead Free)**

7. Performance specification :

Characteristics	Limits	Test Methods ( JIS C 5201-1 )
*Insulation resistance	1,000 MΩ or more	Apply 500V DC between protective coating and termination for 1 min, then measure (Sub-clause 4.6)
*Dielectric withstanding voltage	No evidence of flashover mechanical damage, arcing or insulation break down	Apply 100V(0402) 300V(0603) & 500V (0805,1206,1210,2010,2512) AC between protective coating and termination for 1 minute (Sub-clause 4.7)
Temperature coefficient	Refer to item 5.	Natural resistance change per temp. degree centigrade. $\frac{R_2 - R_1}{R_1(t_2 - t_1)} \times 10^6 \text{ (PPM/}^\circ\text{C)}$ R1: Resistance value at room temperature (t1) R2: Resistance value at room temp. plus 100 °C (t2) (Sub-clause 4.8)
Short time overload	Resistance change rate is ± 5% (2.0% + 0.1Ω) Max. ± 1% (1.0% + 0.1Ω) Max.	Permanent resistance change after the application of a potential of 2.5 times RCWV for 5 seconds (Sub-clause 4.13)
*Solderability	95 % coverage Min.	Test temperature of solder : 245 ± 3°C Dipping them solder : 2-3 seconds (Sub-clause 4.17)
Soldering temp. reference	Electrical characteristics shall be satisfied. Without distinct deformation in appearance. (95 % coverage Min.)	<p><u>Wave soldering condition:</u> (2 cycles Max.)</p> <p>Pre-heat : 100 ~ 120 °C, 30 ± 5 sec. Suggestion solder temp.: 235 ~ 255 °C, 10 sec. (Max.) Peak temp.: 260 °C</p> <p><u>Reflow soldering condition:</u> (2 cycles Max.)</p> <p>Pre-heat : 150 ~ 180 °C, 90 ~ 120 sec. Suggestion solder temp.: 235 ~ 255 °C, 20 ~ 40 sec. Peak temp.: 260 °C</p>  <p><u>Hand soldering condition:</u></p> <p>The soldering iron tip temperature should be less than 300°C and maximum contact time should be 5 sec.</p>



**Thick Film Chip Resistors (Terminal Lead Free)**

7. Performance specification :

Characteristics	Limits	Test Methods ( JIS C 5201-1 )															
Soldering Heat	Resistance change rate is: $\pm(1\%+0.05\Omega)$ Max.	Dip the resistor into a solder bath having a temperature of $260^{\circ}\text{C}\pm 3^{\circ}\text{C}$ and hold it for $10\pm 1$ seconds. (Sub-clause 4.18)															
Temperature cycling	Resistance change rate is $\pm 5\%$ ( $1.0\% + 0.05\Omega$ ) Max. $\pm 1\%$ ( $0.5\% + 0.05\Omega$ ) Max.	Resistance change after continuous 5 cycles for duty cycle specified below :															
		<table border="1"> <thead> <tr> <th>Step</th> <th>Temperature</th> <th>Time</th> </tr> </thead> <tbody> <tr> <td>1</td> <td><math>-55^{\circ}\text{C} \pm 3^{\circ}\text{C}</math></td> <td>30 mins</td> </tr> <tr> <td>2</td> <td>Room temp.</td> <td>10~15 mins</td> </tr> <tr> <td>3</td> <td><math>+155^{\circ}\text{C} \pm 2^{\circ}\text{C}</math></td> <td>30 mins</td> </tr> <tr> <td>4</td> <td>Room temp.</td> <td>10~15 mins</td> </tr> </tbody> </table>	Step	Temperature	Time	1	$-55^{\circ}\text{C} \pm 3^{\circ}\text{C}$	30 mins	2	Room temp.	10~15 mins	3	$+155^{\circ}\text{C} \pm 2^{\circ}\text{C}$	30 mins	4	Room temp.	10~15 mins
		Step	Temperature	Time													
		1	$-55^{\circ}\text{C} \pm 3^{\circ}\text{C}$	30 mins													
		2	Room temp.	10~15 mins													
3	$+155^{\circ}\text{C} \pm 2^{\circ}\text{C}$	30 mins															
4	Room temp.	10~15 mins															
(Sub-clause 4.19)																	
Load life in humidity	Resistance change rate is $\pm 5\%$ ( $3.0\% + 0.1\Omega$ ) Max. $\pm 1\%$ ( $1.0\% + 0.1\Omega$ ) Max.	Resistance change after 1,000 hours (1.5 hours "on", 0.5 hour "off" ) at RCWV in a humidity chamber controlled at $40^{\circ}\text{C} \pm 2^{\circ}\text{C}$ and 90 to 95 % relative humidity (Sub-clause 4.24.2.1)															
Load Life	Resistance change rate is $\pm 5\%$ ( $3.0\% + 0.1\Omega$ ) Max. $\pm 1\%$ ( $1.0\% + 0.1\Omega$ ) Max.	Permanent resistance change after 1,000 hours operating at RCWV, with duty cycle of (1.5 hours"on", 0.5 hour"off") at $70^{\circ}\text{C} \pm 2^{\circ}\text{C}$ ambient (Sub-clause 4.25.1)															
Terminal bending	Resistance change rate is $\pm (1.0\% + 0.05\Omega)$ Max.	Twist of Test Board : Y/X = 5/90 mm for 10 seconds (Sub-clause 4.33)															

The resistors of 0Ω only can do the characteristic noted of \*

### Thick Film Chip Resistors (Terminal Lead Free)

#### 8. Packing specification :

\* Taping Dimension (mm)

##### A. Paper taping

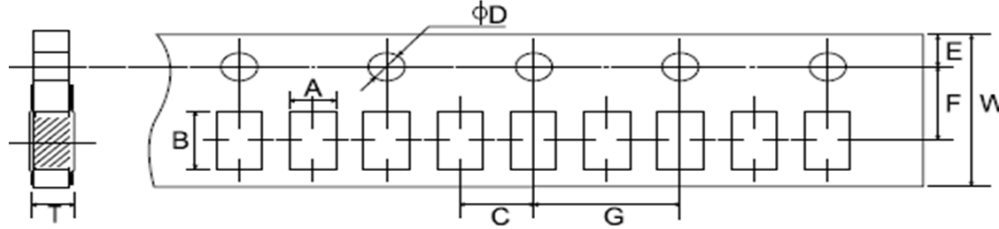

Type	A ± 0.2	B ± 0.2	C ± 0.05	$\phi D +0.1$ - 0	E ± 0.1	F ± 0.05	G ± 0.1	W ± 0.2	T ± 0.1
RMC 0201	0.40±0.05	0.70±0.05	2.0	1.5	1.75	3.5	4.0	8.0	0.42
RMC 0402	0.65±0.1	1.2±0.1	2.0	1.5	1.75	3.5	4.0	8.0	0.42±0.05

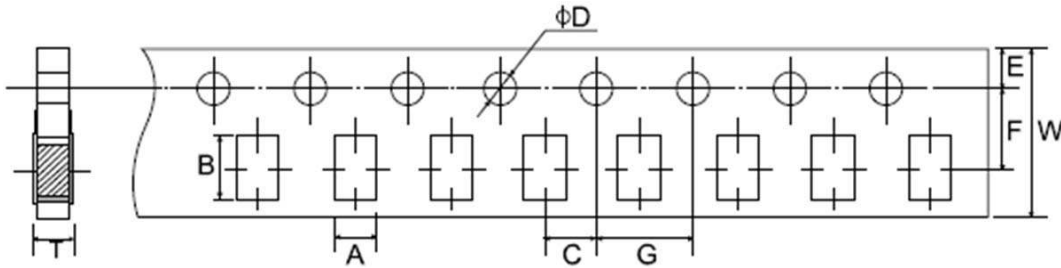

Type	A ± 0.2	B ± 0.2	C ± 0.05	$\phi D +0.1$ - 0	E ± 0.1	F ± 0.05	G ± 0.1	W ± 0.2	T ± 0.1
RMC 0603	1.10	1.90	2.0	1.5	1.75	3.5	4.0	8.0	0.67
RMC 0805	1.65	2.40	2.0	1.5	1.75	3.5	4.0	8.0	0.81
RMC 1206	2.00	3.60	2.0	1.5	1.75	3.5	4.0	8.0	0.81
RMC 1210	2.80	3.50	2.0	1.5	1.75	3.5	4.0	8.0	0.75

##### B. Embossed taping

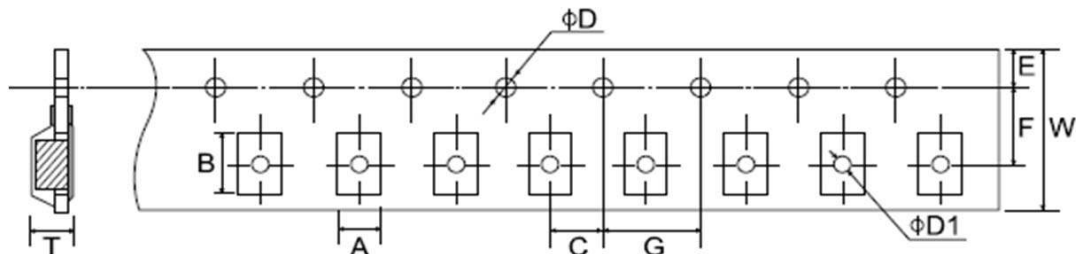

Type	A ± 0.2	B ± 0.2	C ± 0.05	$\phi D +0.1$ - 0	$\phi D1 +0.1$ - 0	E ± 0.1	F ± 0.05	G ± 0.1	W ± 0.2	T ± 0.1
RMC 1812	3.50	4.80	2.0	1.5	1.5	1.75	5.5	4.0	12.0	1.0
RMC 2010	2.90	5.60	2.0	1.5	1.5	1.75	5.5	4.0	12.0	1.0
RMC 2512	3.50	6.70	2.0	1.5	1.5	1.75	5.5	4.0	12.0	1.0

### Thick Film Chip Resistors (Terminal Lead Free)

**\* Peeling Strength of Top Cover Tape**

Test Condition: 0.1 to 0.7 N at a peel-off speed of 300 mm / min.



**\* Reel Dimension (mm)**



Type	Packaging	Quantity Per Reel	A ± 0.5	B ± 0.5	C ± 0.5	D ± 1	M ± 2	W ± 1
RMC 0201	Paper	15,000 pcs.	2	13	21	60	178	10
RMC 0402	Paper	10,000 pcs.	2	13	21	60	178	10
RMC 0603	Paper	5,000 pcs.	2	13	21	60	178	10
RMC 0805	Paper	5,000 pcs.	2	13	21	60	178	10
RMC 1206	Paper	5,000 pcs.	2	13	21	60	178	10
RMC 1210	Paper	5,000 pcs.	2	13	21	60	178	10
RMC 1812	Embossed	4,000 pcs.	2	13	21	60	178	13.8
RMC 2010	Embossed	4,000 pcs.	2	13	21	60	178	13.8
RMC 2512	Embossed	4,000 pcs.	2	13	21	60	178	13.8

## Part Number System

### Explanation of Part Number System

#### Thick Film Chip Resistors (Terminal Lead Free)

<b>1</b>	<b>2</b>	<b>3</b>	<b>4</b>	<b>5</b>	<b>6</b>	<b>7</b>	<b>8</b>	<b>9</b>	<b>10</b>	<b>11</b>	<b>12</b>	<b>13</b>	<b>14</b>
0	6	0	3	W	A	F	7	5	0	J	T	5	E

**Product Type:**  
 Fill-in these 4 digits with the Chip resistor types as follows:

- 0201
- 0402
- 0603
- 0805
- 1206
- 1210
- 1812
- 2010
- 2512

**Wattage:**  
**Normal size:**  
 WH = 1/32W  
 WM = 1/20W  
 WG = 1/16W  
 WA = 1/10W  
 W8 = 1/8W  
 W4 = 1/4W  
 W2 = 1/2W  
 1W = 1W

**Tolerance:**  
 F ~ ± 1%  
 J ~ ± 5%

**Resistance Value:**  
**2%, 5% series:** the 1st digit is "0", the 2nd & 3rd digits are for the significant figures of the resistance and the 4th indicate the number of zeros following;  
**0.5%, 1% series:** the 1st to 3rd digits are for the significant figures of the resistance and the 4th digit indicate the number of zeros following.  
 Decimal point is expressed :  
 "J"~ 0.1, "K"~0.01, "L"~0.001  
 Ex: 2 Ω 26 ~226K, 226 Ω ~2260

**Packing Quantity:**  
 4 = 4,000pcs  
 5 = 5,000pcs  
 C = 10,000pcs  
 E = 15,000pcs

**Packing Type:**  
 T = T/R Packing

**Special Feature:**  
 0 = NIL  
 E = Lead Free

Sample :            RMC 1/10W    (0603) +/- 1%    75Ω    T/R--5,000    →    0603WAF750JT5E  
                          RMC 1/10W    (0603) +/- 5%    75Ω    T/R--5,000    →    0603WAJ0750T5E

## **Thick Film Chip Resistors (Terminal Lead Free)**

### **Environment Related Substance**

This product complies to EU RoHS directive, EU PAHs directive, EU PFOS directive and Halogen free.

Ozone layer depleting substances.

Ozone depleting substances are not used in our manufacturing process of this product.

This product is not manufactured using Chloro fluorocarbons (CFCs), Hydrochlorofluorocarbons (HCFCs), Hydrobromofluorocarbons (HBFCs) or other ozone depleting substances in any phase of the manufacturing process.

### **Storage Condition (MSL1)**

The performance of these products, including the solderability, is guaranteed for a year from the date of arrival at your company, provided that they remain packed as they were when delivered and stored at a temperature of  $25^{\circ}\text{C} \pm 10^{\circ}\text{C}$  and a relative humidity of  $60\%\text{RH} \pm 10\%\text{RH}$ , chemical and dust free atmosphere

Even within the above guarantee periods, do not store these products in the following conditions. Otherwise, their electrical performance and/or solderability may be deteriorated, and the packaging materials (e.g. taping materials) may be deformed or deteriorated, resulting in mounting failures.

1. In salty air or in air with a high concentration of corrosive gas, such as  $\text{Cl}_2$ ,  $\text{H}_2\text{S}$ ,  $\text{NH}_3$ ,  $\text{SO}_2$ , or  $\text{NO}_2$
2. In direct sunlight