

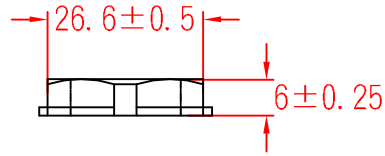

AG-20SR

螺帽
LOCK NUT



墊片
WASHER



本體
BODY

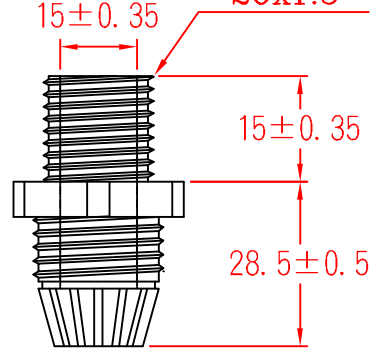

夾緊爪
CLAW

夾緊圈
SEALS

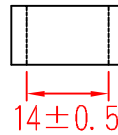

迫緊頭
NUT

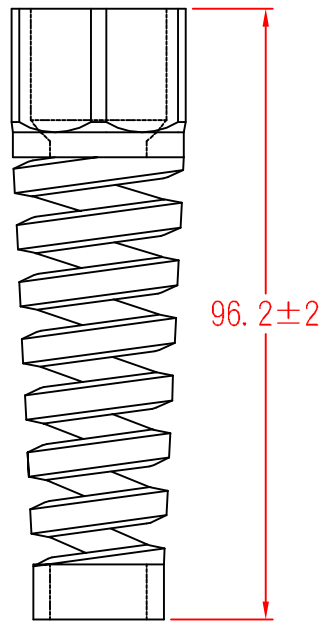

承認
KSS
98.05.13
邱平裕

審查

製圖
KSS
98.05.13
謝文通

設計

中文名
耐扭外迫式電纜固定頭

MATERIAL
UL 94V-2
NYLON 66

ITEM NO.
AG-20SR

SCALE

FINISH

NAME
NYLON CABLE GLAND (WITH STRAIN RELIEF)



(. .)

TOLERANCE
AS FIGURE



05-13-2009
DATE

REVISIONS
K002

R.NO.

使用機種



凱士士企業股份有限公司

請勿實測圖面