

# BC549C, BC550C

## Low Noise Transistors

### NPN Silicon

#### Features

- These are Pb-Free Devices\*

#### MAXIMUM RATINGS

Rating	Symbol	Value	Unit
Collector – Emitter Voltage BC549C BC550C	$V_{CEO}$	30 45	Vdc
Collector – Base Voltage BC549C BC550C	$V_{CBO}$	30 50	Vdc
Emitter – Base Voltage	$V_{EBO}$	5.0	Vdc
Collector Current – Continuous	$I_C$	100	Vdc
Total Device Dissipation @ $T_A = 25^\circ\text{C}$ Derate above = $25^\circ\text{C}$	$P_D$	625 5.0	mW mW/ $^\circ\text{C}$
Total Device Dissipation @ $T_A = 25^\circ\text{C}$ Derate above = $25^\circ\text{C}$	$P_D$	1.5 12	W mW/ $^\circ\text{C}$
Operating and Storage Junction Temperature Range	$T_J, T_{stg}$	-55 to +150	$^\circ\text{C}$

#### THERMAL CHARACTERISTICS

Characteristic	Symbol	Max	Unit
Thermal Resistance, Junction-to-Ambient	$R_{\theta JA}$	200	$^\circ\text{C}/\text{W}$
Thermal Resistance, Junction-to-Case	$R_{\theta JC}$	83.3	$^\circ\text{C}/\text{W}$

Stresses exceeding Maximum Ratings may damage the device. Maximum Ratings are stress ratings only. Functional operation above the Recommended Operating Conditions is not implied. Extended exposure to stresses above the Recommended Operating Conditions may affect device reliability.

\*For additional information on our Pb-Free strategy and soldering details, please download the ON Semiconductor Soldering and Mounting Techniques Reference Manual, SOLDERRM/D.



ON Semiconductor®

<http://onsemi.com>

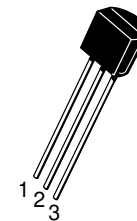
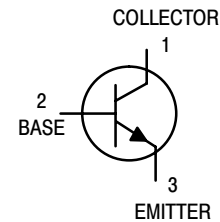

TO-92  
CASE 29  
STYLE 17

STRAIGHT LEAD  
BULK PACK

#### MARKING DIAGRAM

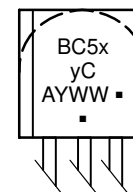

BC5xyC = Device Code  
x = 4 or 5  
y = 9 or 0

A = Assembly Location

Y = Year

WW = Work Week

▪ = Pb-Free Package

(Note: Microdot may be in either location)

#### ORDERING INFORMATION

Device	Package	Shipping
BC549CG	TO-92 (Pb-Free)	5000 Units / Bulk
BC550CG	TO-92 (Pb-Free)	5000 Units / Bulk

# BC549C, BC550C

## ELECTRICAL CHARACTERISTICS (T<sub>A</sub> = 25°C unless otherwise noted)

Characteristic	Symbol	Min	Typ	Max	Unit
<b>OFF CHARACTERISTICS</b>					
Collector–Emitter Breakdown Voltage (I <sub>C</sub> = 10 mA, I <sub>B</sub> = 0)	V <sub>(BR)CEO</sub>	45	–	–	Vdc
Collector–Base Breakdown Voltage (I <sub>C</sub> = 10 μA, I <sub>E</sub> = 0)	V <sub>(BR)CBO</sub>	50	–	–	Vdc
Emitter–Base Breakdown Voltage (I <sub>E</sub> = 10 μA, I <sub>C</sub> = 0)	V <sub>(BR)EBO</sub>	5.0	–	–	Vdc
Collector Cutoff Current (V <sub>CB</sub> = 30 V, I <sub>E</sub> = 0) (V <sub>CB</sub> = 30 V, I <sub>E</sub> = 0, T <sub>A</sub> = +125°C)	I <sub>CBO</sub>	–	–	15 5.0	nA μA
Emitter Cutoff Current (V <sub>EB</sub> = 4.0 Vdc, I <sub>C</sub> = 0)	I <sub>EBO</sub>	–	–	15	nA

<b>ON CHARACTERISTICS</b>					
DC Current Gain (I <sub>C</sub> = 10 μA, V <sub>CE</sub> = 5.0 Vdc) (I <sub>C</sub> = 2.0 mA, V <sub>CE</sub> = 5.0 Vdc)	h <sub>FE</sub>	100 420	270 500	– 800	–
Collector–Emitter Saturation Voltage (I <sub>C</sub> = 10 mA, I <sub>B</sub> = 0.5 mA) (I <sub>C</sub> = 10 mA, I <sub>B</sub> = see note 1) (I <sub>C</sub> = 100 mA, I <sub>B</sub> = 5.0 mA, see note 2)	V <sub>CE(sat)</sub>	– – –	0.075 0.3 0.25	0.25 0.6 0.6	Vdc
Base–Emitter Saturation Voltage (I <sub>C</sub> = 100 mA, I <sub>B</sub> = 5.0 mA)	V <sub>BE(sat)</sub>	–	1.1	–	Vdc
Base–Emitter On Voltage (I <sub>C</sub> = 10 μA, V <sub>CE</sub> = 5.0 Vdc) (I <sub>C</sub> = 100 μA, V <sub>CE</sub> = 5.0 Vdc) (I <sub>C</sub> = 2.0 mA, V <sub>CE</sub> = 5.0 Vdc)	V <sub>BE(on)</sub>	– – 0.55	0.52 0.55 0.62	– – 0.7	Vdc

<b>SMALL-SIGNAL CHARACTERISTICS</b>					
Current–Gain — Bandwidth Product (I <sub>C</sub> = 10 mA, V <sub>CE</sub> = 5.0 Vdc, f = 100 MHz)	f <sub>T</sub>	–	250	–	MHz
Collector–Base Capacitance (V <sub>CB</sub> = 10 Vdc, I <sub>E</sub> = 0, f = 1.0 MHz)	C <sub>cbo</sub>	–	2.5	–	pF
Small–Signal Current Gain (I <sub>C</sub> = 2.0 mA, V <sub>CE</sub> = 5.0 V, f = 1.0 kHz)	h <sub>fe</sub>	450	600	900	–
Noise Figure (I <sub>C</sub> = 200 μA, V <sub>CE</sub> = 5.0 Vdc, R <sub>S</sub> = 2.0 kΩ, f = 1.0 kHz) (I <sub>C</sub> = 200 μA, V <sub>CE</sub> = 5.0 Vdc, R <sub>S</sub> = 100 kΩ, f = 1.0 kHz)	NF <sub>1</sub> NF <sub>2</sub>	– –	0.6 –	2.5 10	dB

- I<sub>B</sub> is value for which I<sub>C</sub> = 11 mA at V<sub>CE</sub> = 1.0 V.
- Pulse test = 300 μs – Duty cycle = 2%.

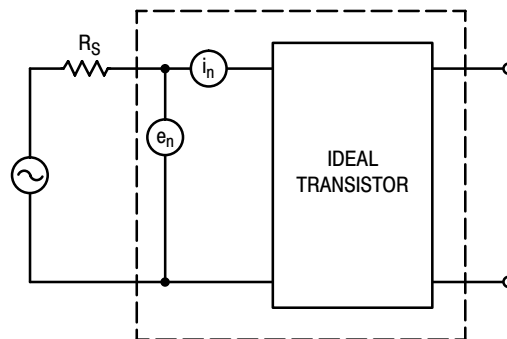

**Figure 1. Transistor Noise Model**

# BC549C, BC550C

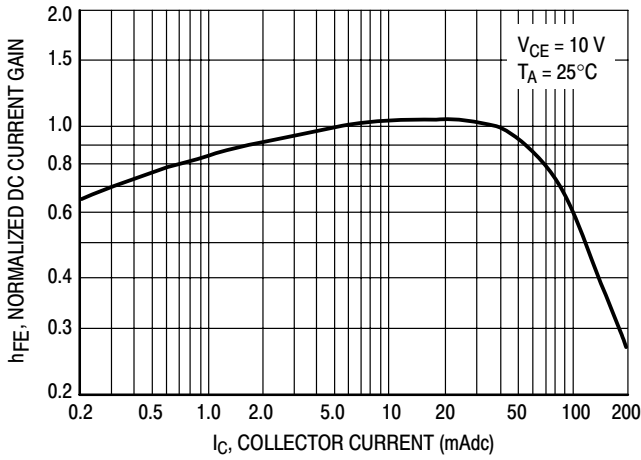

Figure 2. Normalized DC Current Gain

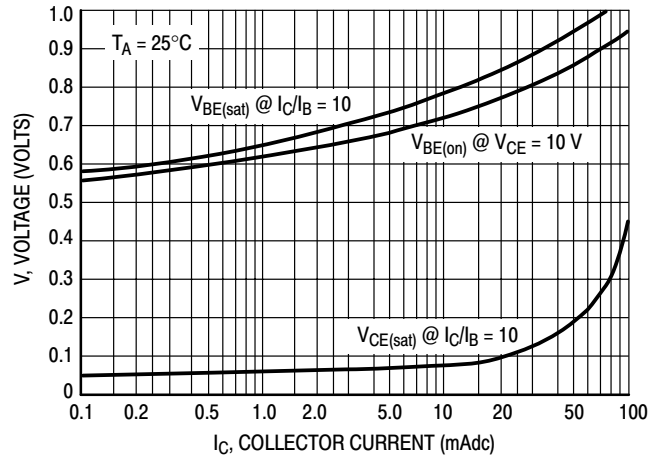

Figure 3. "Saturation" and "On" Voltages

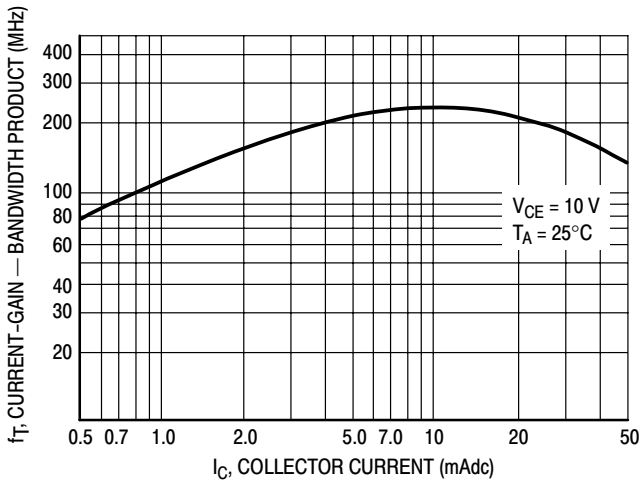

Figure 4. Current-Gain — Bandwidth Product

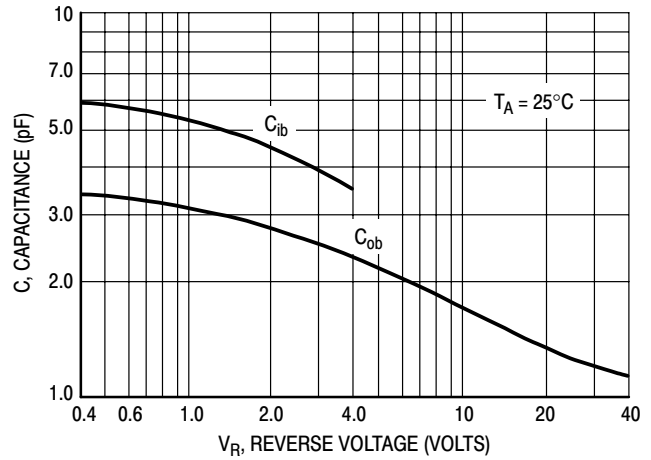

Figure 5. Capacitance

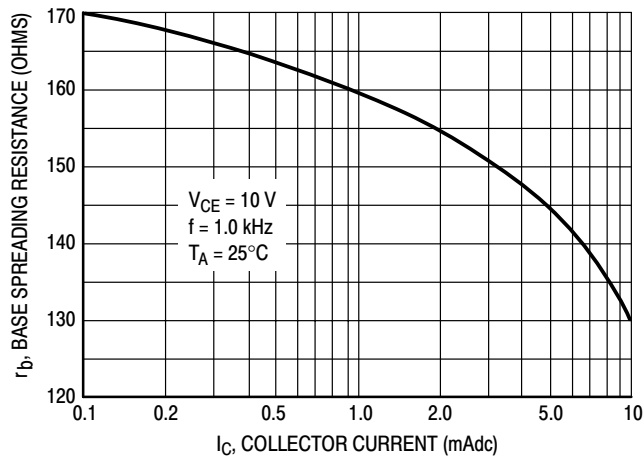
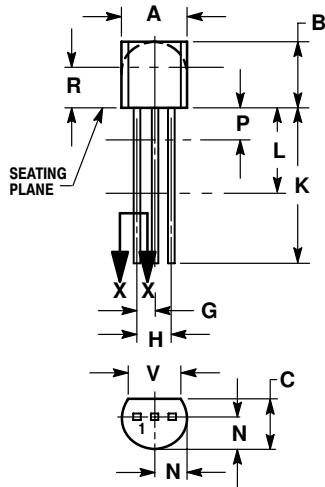

Figure 6. Base Spreading Resistance

# BC549C, BC550C

## PACKAGE DIMENSIONS

TO-92 (TO-226)  
CASE 29-11  
ISSUE AM



STRAIGHT LEAD  
BULK PACK

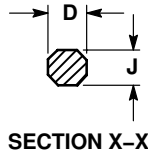

SECTION X-X

NOTES:

1. DIMENSIONING AND TOLERANCING PER ANSI Y14.5M, 1982.
2. CONTROLLING DIMENSION: INCH.
3. CONTOUR OF PACKAGE BEYOND DIMENSION R IS UNCONTROLLED.
4. LEAD DIMENSION IS UNCONTROLLED IN P AND BEYOND DIMENSION K MINIMUM.

DIM	INCHES		MILLIMETERS	
	MIN	MAX	MIN	MAX
A	0.175	0.205	4.45	5.20
B	0.170	0.210	4.32	5.33
C	0.125	0.165	3.18	4.19
D	0.016	0.021	0.407	0.533
G	0.045	0.055	1.15	1.39
H	0.095	0.105	2.42	2.66
J	0.015	0.020	0.39	0.50
K	0.500	---	12.70	---
L	0.250	---	6.35	---
N	0.080	0.105	2.04	2.66
P	---	0.100	---	2.54
R	0.115	---	2.93	---
V	0.135	---	3.43	---

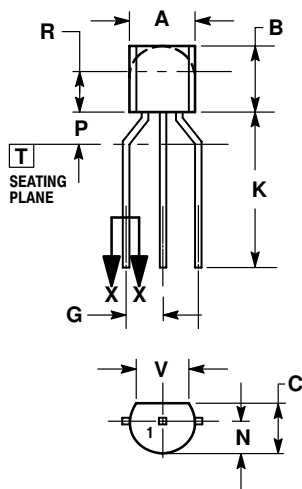

BENT LEAD  
TAPE & REEL  
AMMO PACK

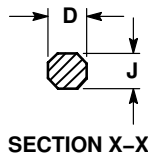

SECTION X-X

NOTES:

1. DIMENSIONING AND TOLERANCING PER ASME Y14.5M, 1994.
2. CONTROLLING DIMENSION: MILLIMETERS.
3. CONTOUR OF PACKAGE BEYOND DIMENSION R IS UNCONTROLLED.
4. LEAD DIMENSION IS UNCONTROLLED IN P AND BEYOND DIMENSION K MINIMUM.

DIM	MILLIMETERS	
	MIN	MAX
A	4.45	5.20
B	4.32	5.33
C	3.18	4.19
D	0.40	0.54
G	2.40	2.80
J	0.39	0.50
K	12.70	---
N	2.04	2.66
P	1.50	4.00
R	2.93	---
V	3.43	---

STYLE 17:

1. COLLECTOR
2. BASE
3. EMITTER

ON Semiconductor and are registered trademarks of Semiconductor Components Industries, LLC (SCILLC). SCILLC reserves the right to make changes without further notice to any products herein. SCILLC makes no warranty, representation or guarantee regarding the suitability of its products for any particular purpose, nor does SCILLC assume any liability arising out of the application or use of any product or circuit, and specifically disclaims any and all liability, including without limitation special, consequential or incidental damages. "Typical" parameters which may be provided in SCILLC data sheets and/or specifications can and do vary in different applications and actual performance may vary over time. All operating parameters, including "Typicals" must be validated for each customer application by customer's technical experts. SCILLC does not convey any license under its patent rights nor the rights of others. SCILLC products are not designed, intended, or authorized for use as components in systems intended for surgical implant into the body, or other applications intended to support or sustain life, or for any other application in which the failure of the SCILLC product could create a situation where personal injury or death may occur. Should Buyer purchase or use SCILLC products for any such unintended or unauthorized application, Buyer shall indemnify and hold SCILLC and its officers, employees, subsidiaries, affiliates, and distributors harmless against all claims, costs, damages, and expenses, and reasonable attorney fees arising out of, directly or indirectly, any claim of personal injury or death associated with such unintended or unauthorized use, even if such claim alleges that SCILLC was negligent regarding the design or manufacture of the part. SCILLC is an Equal Opportunity/Affirmative Action Employer. This literature is subject to all applicable copyright laws and is not for resale in any manner.

### PUBLICATION ORDERING INFORMATION

**LITERATURE FULFILLMENT:**  
Literature Distribution Center for ON Semiconductor  
P.O. Box 5163, Denver, Colorado 80217 USA  
**Phone:** 303-675-2175 or 800-344-3860 Toll Free USA/Canada  
**Fax:** 303-675-2176 or 800-344-3867 Toll Free USA/Canada  
**Email:** orderlit@onsemi.com

**N. American Technical Support:** 800-282-9855 Toll Free  
USA/Canada  
**Europe, Middle East and Africa Technical Support:**  
Phone: 421 33 790 2910  
**Japan Customer Focus Center**  
Phone: 81-3-5773-3850

**ON Semiconductor Website:** [www.onsemi.com](http://www.onsemi.com)  
**Order Literature:** <http://www.onsemi.com/orderlit>

For additional information, please contact your local Sales Representative