

## 10 AMP DPDT MINIATURE POWER RELAY

### FEATURES

- 10 Amp switching capability (N.O. contacts)
- 5 kV dielectric strength, Isolation spacing  $\geq 10$  mm
- Reinforced insulation according IEC 60730-1, IEC 60335-1
- Proof tracking index (PTI/CTI) 250
- AC and DC coils available
- Compact size, low seated height of 15.7 mm
- UL / CUR file E43203
- VDE certificate 40012572

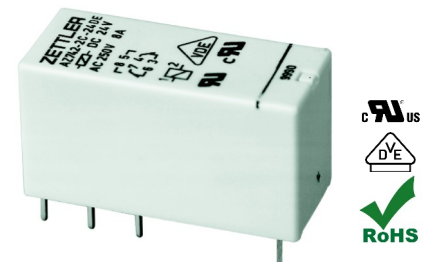

### CONTACTS

<b>Arrangement</b>	DPST-N.O. (2 Form A) DPDT (2 Form C)
<b>Ratings (max.)</b> switched power switched current switched voltage	(resistive load) 2 x 240 W or 2500 VA 2 x 10 A 300 VDC* or 400 VAC  * Note: If switching voltage is greater than 30 VDC, special precautions must be taken. Please contact the factory.
<b>Rated Loads</b> <b>UL, CUR</b>	8 A at 250 VAC, resistive <sup>[1][2]</sup> 10 A at 250 VAC, resistive, 30k cycles (N.O.) <sup>[1]</sup>
<b>VDE</b>	<b>2 Form A - DC coil types</b> 8 A at 250 VAC, 100k cycles, 85°C <sup>[1]</sup> 8 A at 250 VAC, 10k cycles, 85°C <sup>[2]</sup>  <b>2 Form A - AC coil types</b> 8 A at 250 VAC, 80k cycles, 70°C <sup>[1]</sup> 8 A at 250 VAC, 40k cycles, 70°C <sup>[2]</sup>  <b>2 Form C - DC coil types</b> 8 A at 250 VAC, 30k cycles, 70°C <sup>[1]</sup> 8 A at 250 VAC, 20k cycles, 85°C <sup>[1]</sup> 8 A at 250 VAC, 10k cycles, 85°C <sup>[2]</sup>  <b>2 Form C - AC coil types</b> 8 A at 250 VAC, 80k cycles, 70°C <sup>[1]</sup> 8 A at 250 VAC, 10k cycles, 70°C <sup>[2]</sup>
<b>Contact material</b>	AgNi / AgNi+Au (silver nickel, gold plating available) <sup>[1]</sup> AgSnO <sub>2</sub> (silver tin oxide) <sup>[2]</sup>
<b>Initial resistance</b>	$\leq 100$ m $\Omega$

### COIL

<b>Nominal coil voltages</b>	see coil voltage specifications tables
<b>Dropout</b> DC coil types AC coil types	> 10% of nominal coil voltage > 15% of nominal coil voltage
<b>Coil power</b> DC coil types nominal max. continuous at pickup voltage AC coil types nominal max. continuous at pickup voltage	at 23°C (68°F) ambient temperature  0.4 W (approx.) 1.7 W 200 mW (typ.)  0.75 VA (approx.) 1.7 VA 0.42 VA (typ.)
<b>Temperature Rise</b>	26 K (47°F) at nominal coil voltage
<b>Max. temperature</b>	Class F insulation - 155°C (311°F)

### GENERAL DATA

<b>Life Expectancy</b> mechanical electrical	(minimum operations) 3 x 10 <sup>7</sup> 1 x 10 <sup>5</sup> at 8 A 250VAC resistive
<b>Operate Time</b>	7 ms (typ.) at nominal coil voltage
<b>Release Time</b>	3 ms (typ.) at nominal coil voltage, without coil suppression
<b>Dielectric Strength</b>	(at sea level for 1 min.) 5000 V <sub>RMS</sub> coil to contact 2500 V <sub>RMS</sub> between contact sets 1000 V <sub>RMS</sub> between open contacts
<b>Insulation Resistance</b>	10 <sup>5</sup> M $\Omega$ (min.) at 20°C, 500 VDC, 50% RH
<b>Isolation spacing</b> clearance creepage	(coil to contact) $\geq 10$ mm $\geq 10$ mm
<b>Insulation</b>	B250 (2 Form C, flux proof versions) C250 (other versions) Overvoltage category: III Pollution degree: 3 Nominal voltage: 250 VAC (according to DIN VDE 0110, IEC 60664-1) Reinforced insulation according to IEC 60730-1 (VDE 0631, part 1) IEC 60335-1 (VDE 0700, part 1)
<b>Temperature Range</b> operating DC coil types AC coil types	(at nominal coil voltage) -40°C (-40°F) to 85°C (185°F) -40°C (-40°F) to 70°C (158°F)
<b>Vibration resistance</b> N.O. contacts N.C. contacts	20 g at 30 - 500 Hz 5 g at 20 - 500 Hz
<b>Shock resistance</b>	20 g
<b>Enclosure</b> type material group flammability	P.B.T. polyester flux proof, wash tight IIIa UL94 V-0
<b>Terminals</b>	Tinned copper alloy, P. C.
<b>Soldering</b> max. temperature max. time	270 °C (518°F) 5 seconds
<b>Cleaning</b> max. solvent temp. max. immersion time	80°C (176°F) 30 seconds
<b>Dimensions</b> length width height	29.0 mm (1.142") 12.7 mm (0.500") 15.7 mm (0.618")
<b>Weight</b>	14 grams (approx.)
<b>Packing unit in pcs</b>	20 per carton tube / 1000 per carton box
<b>Compliance</b>	UL 508, IEC 61810-1, IEC60335-1 (GWT), RoHS, REACH

# AZ742

## DC COIL VOLTAGE SPECIFICATIONS

Nominal Coil VDC	Must Operate VDC	Max. Cont. VDC	Nom. Current mA ± 10%	Resistance Ohm ± 10%
3	2.1	7.6	136	22
5	3.5	12.7	83.3	60
6	4.2	15.3	66.7	90
9	6.3	22.9	45.0	200
12	8.4	30.6	33.3	360
18	12.6	45.9	25.4	710
24	16.8	61.2	16.7	1440
36	25.2	92.0	11.5	3140
48	33.6	122	8.42	5700
60	42.0	153	8.0	7500
110	77.0	280	4.37	25200

## AC COIL VOLTAGE SPECIFICATIONS

Nominal Coil VAC	Must Operate VAC	Max. Cont. VAC	Nom. Current mA ± 10%	Resistance Ohm ± 10%
12	9.0	18.0	63.0	100
24	18.0	36.0	31.3	400
48	36.0	72.0	15.6	1550
60	45.0	90.0	12.5	2600
110	82.5	165.0	6.8	8900
115	86.3	172.5	6.5	9600
120	90.0	180.0	6.3	10200
220	165.0	330.0	3.4	35500
230	172.5	345.0	3.3	38500
240	180.0	360.0	3.1	42500

## ORDERING DATA

AZ742-□□□-□□□□

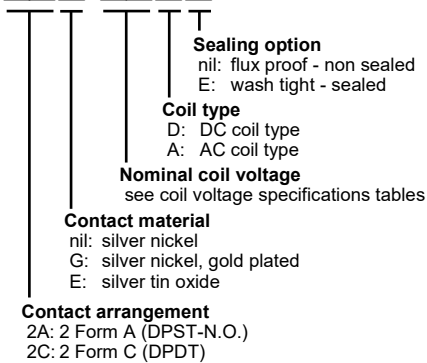

### Example ordering data

- AZ742-2A-9D 2 Form A (DPST-N.O.), silver nickel contacts, 9 VDC nominal coil voltage, flux tight version
- AZ742-2CG-12DE 2 Form C (DPDT), gold plated silver nickel contacts, 12 VDC nominal coil voltage, wash tight version
- AZ742-2AE-230A 2 Form A (DPST-N.O.), silver tin oxide contacts, 230 VAC coil

## DC COIL OPERATING RANGE

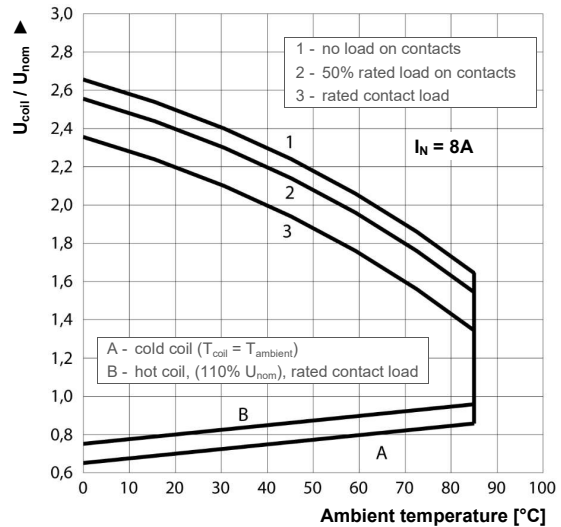

## AC COIL OPERATING RANGE

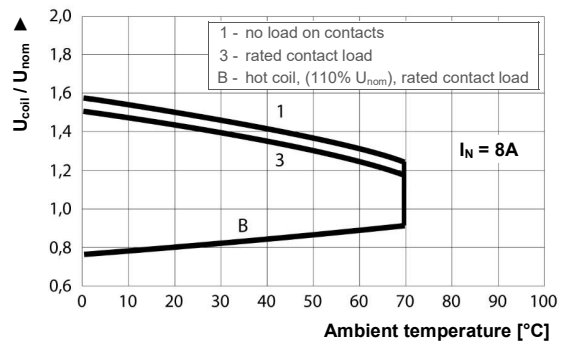

## LIFE EXPECTANCY

Electrical life at 250VAC, resistive load

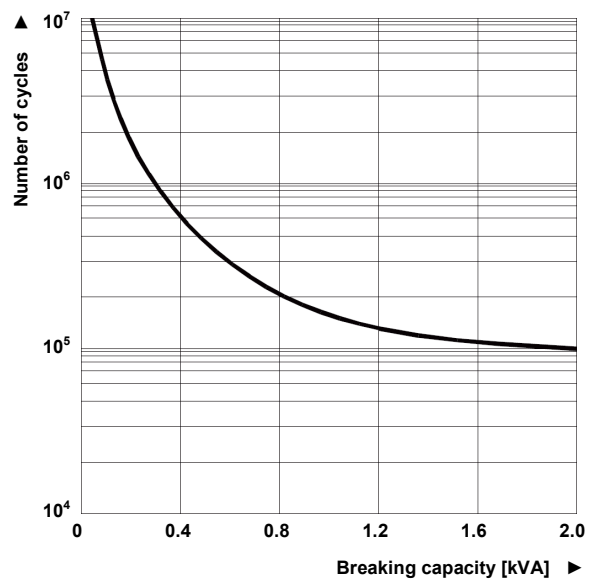

## INDUCTIVE LOADS LIFE REDUCTION

Electrical life reduction factor at inductive AC load

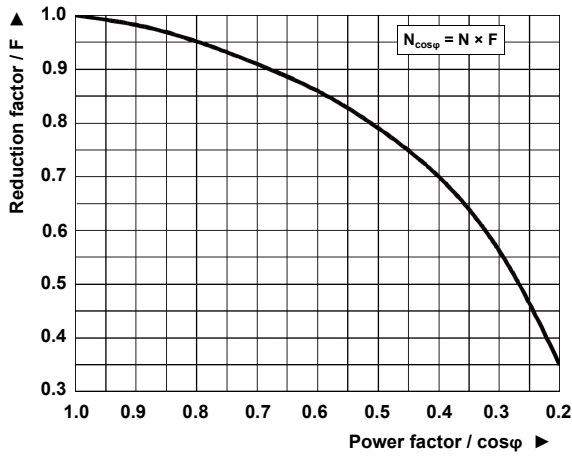

## MAX DC RESISTIVE LOAD BREAKING CAPACITY

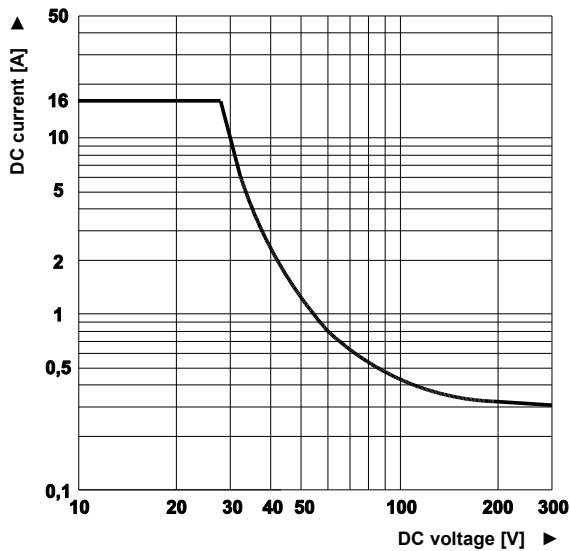

## NOTES

- All values at reference temperature of 23°C (73°F) unless stated otherwise.
- Relay may pull in with less than "Must Operate" value.
- "Max. Continuous Voltage" is the maximum voltage the coil can endure for a short period of time.
- Coil suppression circuits such as diodes, etc. in parallel to the coil will lengthen the release time.
- Relay adjustment may be affected if excessive shock is applied to the relay.
- Relay adjustment may be affected if undue pressure is exerted on the relay case.
- Specifications subject to change without notice.

## MECHANICAL DATA

Dimensions in inches with metric equivalents in parentheses. Tolerance:  $\pm .010"$

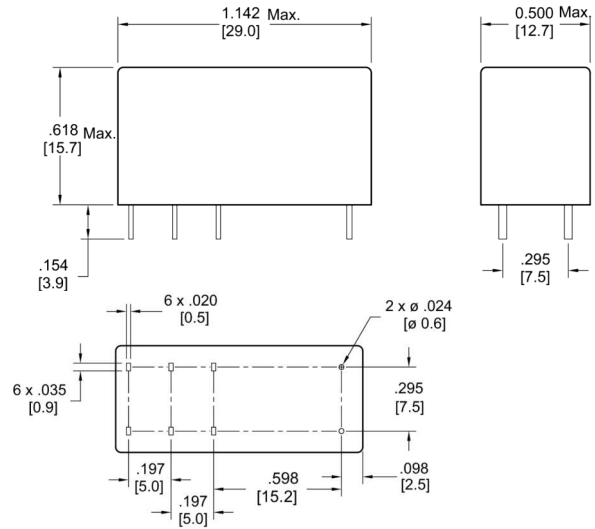

## PC BOARD LAYOUT

Recommendation for PC board layout.

Dimensions in inches with metric equivalents in parentheses. Viewed towards terminals.

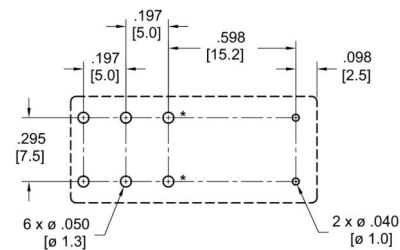

\* Not used on 2 Form A relay

## WIRING DIAGRAMS

Viewed towards terminals.

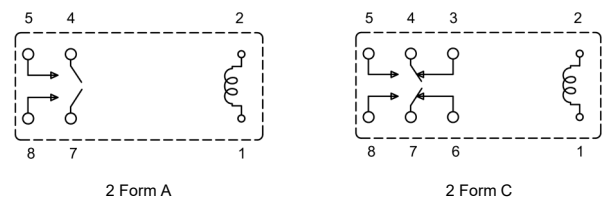

# AZ742

## DISCLAIMER

This product specification is to be used in conjunction with the application notes which can be downloaded from the regional ZETTLER relay websites. The specification provides an overview of the most significant part features. Any individual applications and operating conditions are not taken into consideration. It is recommended to test the product under application conditions. Responsibility for the application remains with the customer. Proper operation and service life cannot be guaranteed if the part is operated outside the specified limits.

## ZETTLER GROUP

Building on a foundation of more than a century of expertise in German precision engineering, ZETTLER Group is a world-class enterprise, engaged in the design, manufacturing, sales and distribution of electronic components. Our industry leadership is based on a unique combination of engineering competence and global scale.

For more information on other ZETTLER Group companies, please visit [ZETTLER-group.com](https://www.zettler-group.com). For support on this product or other ZETTLER relays, please visit one of the group sites below.

## SITES FOR ZETTLER RELAYS

### NORTH AMERICA

American Zettler, Inc.  
[www.azettler.com](https://www.azettler.com)  
[sales@azettler.com](mailto:sales@azettler.com)

### EUROPE

Zettler Electronics, GmbH  
[www.zettlerelectronics.com](https://www.zettlerelectronics.com)  
[office@zettlerelectronics.com](mailto:office@zettlerelectronics.com)

Zettler Electronics, Poland  
[www.zettlerelectronics.pl](https://www.zettlerelectronics.pl)  
[office@zettlerelectronics.pl](mailto:office@zettlerelectronics.pl)

### CHINA

Zettler Group, China  
[www.zettlercn.com](https://www.zettlercn.com)  
[relay@zettlercn.com](mailto:relay@zettlercn.com)

### ASIA PACIFIC

Zettler Electronics (HK) Ltd.  
[www.zettlerhk.com](https://www.zettlerhk.com)  
[sales@zettlerhk.com](mailto:sales@zettlerhk.com)



**ZETTLER**